



**INSTALLATION INSTRUCTIONS**  
**BLACK MODULAR GRILLE GUARD FOR GMC ENVOY 02-09**  
**PART # 17GD26MA**

## Before Installation









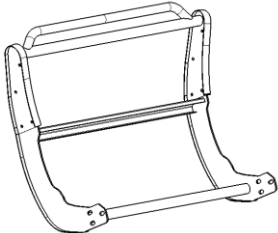
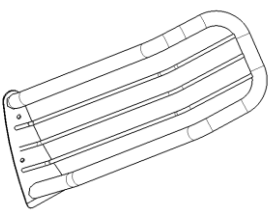
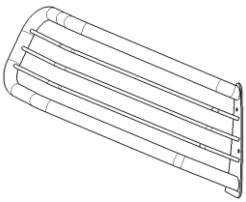
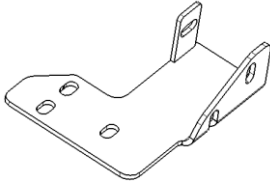
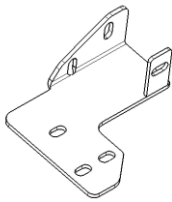
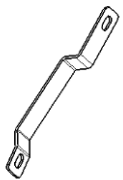

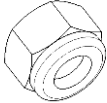



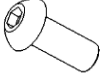

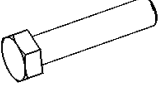

- Please read the instruction completely for easy installation, which will also help you to avoid scratches or other potential damages to your appealing car.
- The information shown here is for reference only and may differ from the product that you receive, however the goods are fitted in the same way.

## Care and Cleaning

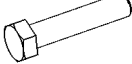
- Mild soap may be used also to clean the Product.
- Please periodically check and retighten all the hardware and clean the investment for a refresh look.

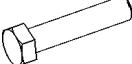
## Parts List

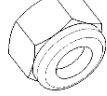
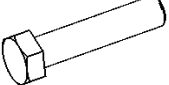
NO.	QTY	NAME	NO.	QTY	NAME
①	1	 Front Guard	②	1	 Left Brush Guard
③	1	 Right Brush Guard	④	1	 Passenger/Right Side Frame Mounting Bracket
⑤	1	 Passenger/Right Side Frame Mounting Bracket	⑥	2	 Driver/Passenger Left Top Support Bracket

<p>⑦</p>	<p>14</p>	 <p>8mm Nylon Lock Nuts</p>	<p>⑧</p>	<p>1</p>	 <p>Wrench Allen wrench S=5</p>
<p>⑨</p>	<p>1</p>	 <p>Wrench Allen wrench S=4</p>	<p>⑩</p>	<p>16</p>	 <p>8mm x 24mm OD x 2mm Large Flat Washers</p>
<p>⑪</p>	<p>8</p>	 <p>8 x 25mm Button Head Bolts</p>	<p>⑫</p>	<p>4</p>	 <p>10mm Lock Washers</p>
<p>⑬</p>	<p>6</p>	 <p>12x 40mm Hex Bolts</p>	<p>⑭</p>	<p>12</p>	 <p>8mm x 28mm OD x3mm extra-large washer</p>
<p>⑮</p>	<p>12</p>	 <p>12mm x 37mm OD x 3mm Large Flat Washers</p>	<p>⑯</p>	<p>6</p>	 <p>12mm Hex Bolts</p>
<p>⑰</p>	<p>8</p>	 <p>10mm x 34mm OD x3mm extra-large washer</p>	<p>⑱</p>	<p>6</p>	 <p>12mm Lock Washers</p>
<p>⑲</p>	<p>2</p>	 <p>8x 20mm Hex Bolts</p>	<p>⑳</p>	<p>2</p>	 <p>6mm Lock Washers</p>
<p>㉑</p>	<p>4</p>	 <p>10x 25mm Hex Bolts</p>	<p>㉒</p>	<p>2</p>	 <p>6 x 20mm Button Head Bolts</p>
<p>㉓</p>	<p>4</p>	 <p>6mm x 12 mm OD x 1.6mm Flat Washers</p>	<p>㉔</p>	<p>4</p>	 <p>10mm Nylon Lock Nuts</p>
<p>㉕</p>	<p>4</p>	 <p>8x 25mm Hex Bolts</p>	<p>㉖</p>	<p>2</p>	 <p>6mm Hex Bolts</p>

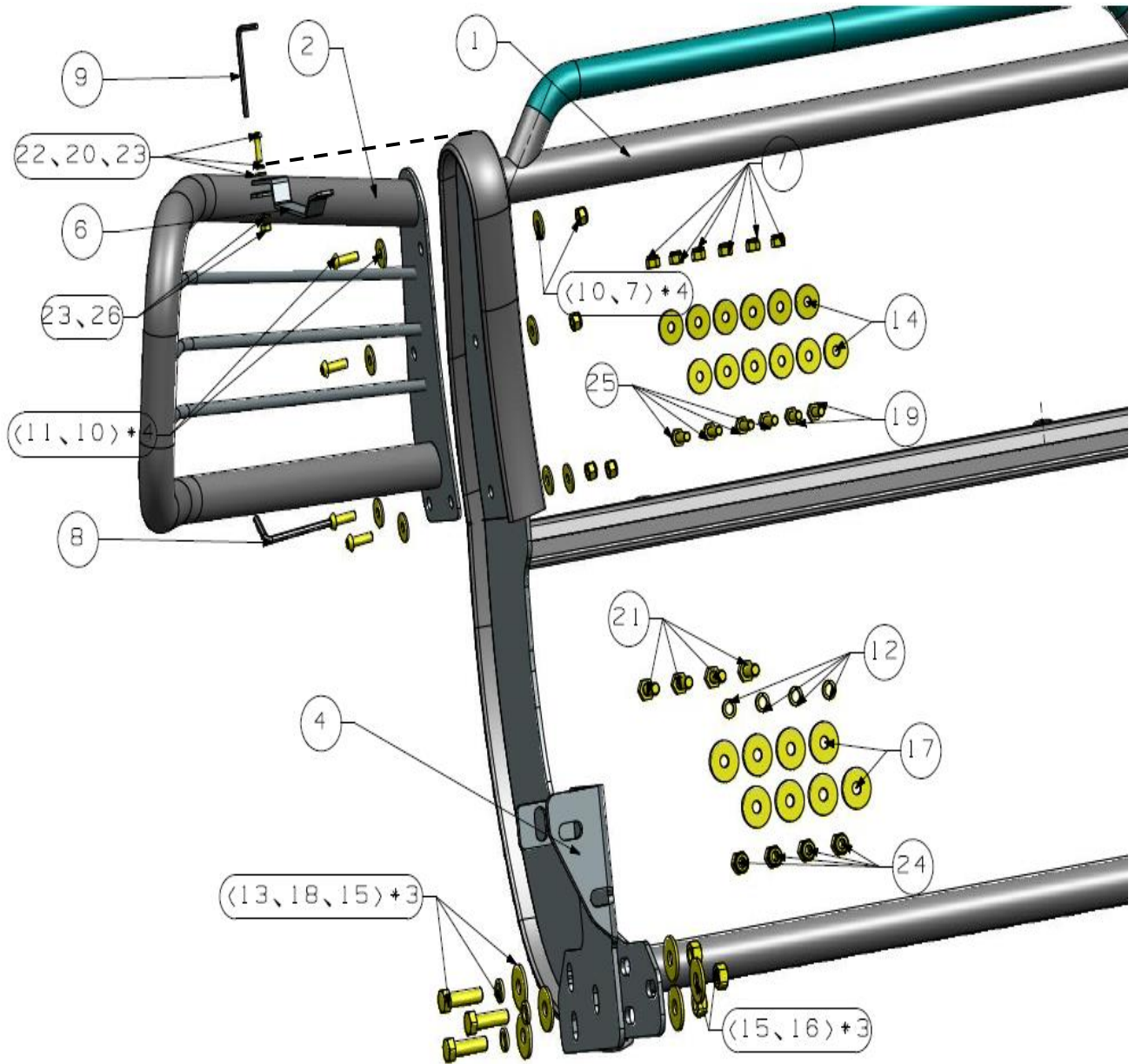

## INSTALLATION INSTRUCTIONS

### INSTALLING FRONT BAR

1. Remove factory bottom plastic balance underneath vehicle.
2. Attach the passenger side assembly, remove the factory bolt on the frame channel, and once the bolt is removed, align the passenger side bracket with the three matching holes in the frame channel as shown in illustration. Attach using the ⑳ 10 x 25mm hex bolts, ㉔ M8 hex nuts, ㉑ M8 flat washer, ㉒ 10 mm Lock Washers , ㉕ 8 x 25mm hex bolts, ㉖ 8mm flat washers and ㉗ 8mm hex nuts.
3. Attach the front bar assembly to the inner side of the lower brackets using the ㉓ 12 x 40mm hex bolts, ㉔ 12mm hex nuts, ㉕ 12mm Lock Washers and ㉖ 12mm flat washers.
4. Install top support brackets – open hood to expose existing holes. Locate holes and line-up top support brackets, align as shown in illustration. Attach using the ㉗ 8 x20mm hex bolts, ㉘ 8mm flat washers and ㉙ 8mm hex nuts. Align the other end of top support bracket to the arms for the front bar attaching using the ㉚ 6 x20mm screws, ㉛ 6mm flat washers, ㉜ 6mm Lock Washers and ㉝ 6mm hex nuts.
5. Left/ Right Brush Guard and Front Guard Attach using the ㉞ 8 x25mm screws, ㉟ 8mm flat washers and ㊱ hex nuts.
6. To re-attach the factory bottom plastic balance use a utility knife and carefully cut slots in the plastic balance to fit around the frame mounting brackets or remove and discard.
7. Align the front bar assembly with the front of the vehicle and tighten all fasteners.  
{Note: **regarding V8 models...** you will find a guard on the underside of the radiator. Simply remove and discard this part prior to install. }