



**BLACK HORSE
OFF ROAD®**

TEL : 1-866-XANATOS

INSTALLATION INSTRUCTIONS

ELITE RETRACTABLE POWER BOARD

**10-24 TOYOTA 4RUNNER (Excl. 10-23 Limited & 19-22 Nightshade Edition or
models with Lower Rocker Panel Extensions)**

Patented

PART#PWBR4063

INSTALLATION INSTRUCTIONS

Mechanical PARTS LIST:

Qty	Item Description	Qty	Item Description
2	Running Boards	8	M8 x 30mm Hex Bolts
1	Driver/Left Front Bracket Assembly	12	M8 Lock Washers
1	Passenger/Right Front Bracket Assembly	8	M8 Large Flat Washers
1	Driver/Left Rear Bracket Assembly	4	M8 Small Flat Washers
1	Passenger/Right Rear Bracket Assembly	4	M8 Hex Nuts
1	Electronic Materials Package	4	Plastic retainers
8	M6 Carriage Bolts	4	M8 x 40mm Bolt Plates
8	M6 Flange Nuts	2	Foam strips

Electronic Materials Package PARTS LIST:

Qty	Item Description	Qty	Item Description
1	Main Harness	1	ECU
2	LED Y-Harness	4	LED lights
2	Wire Taps	15	Zip Ties

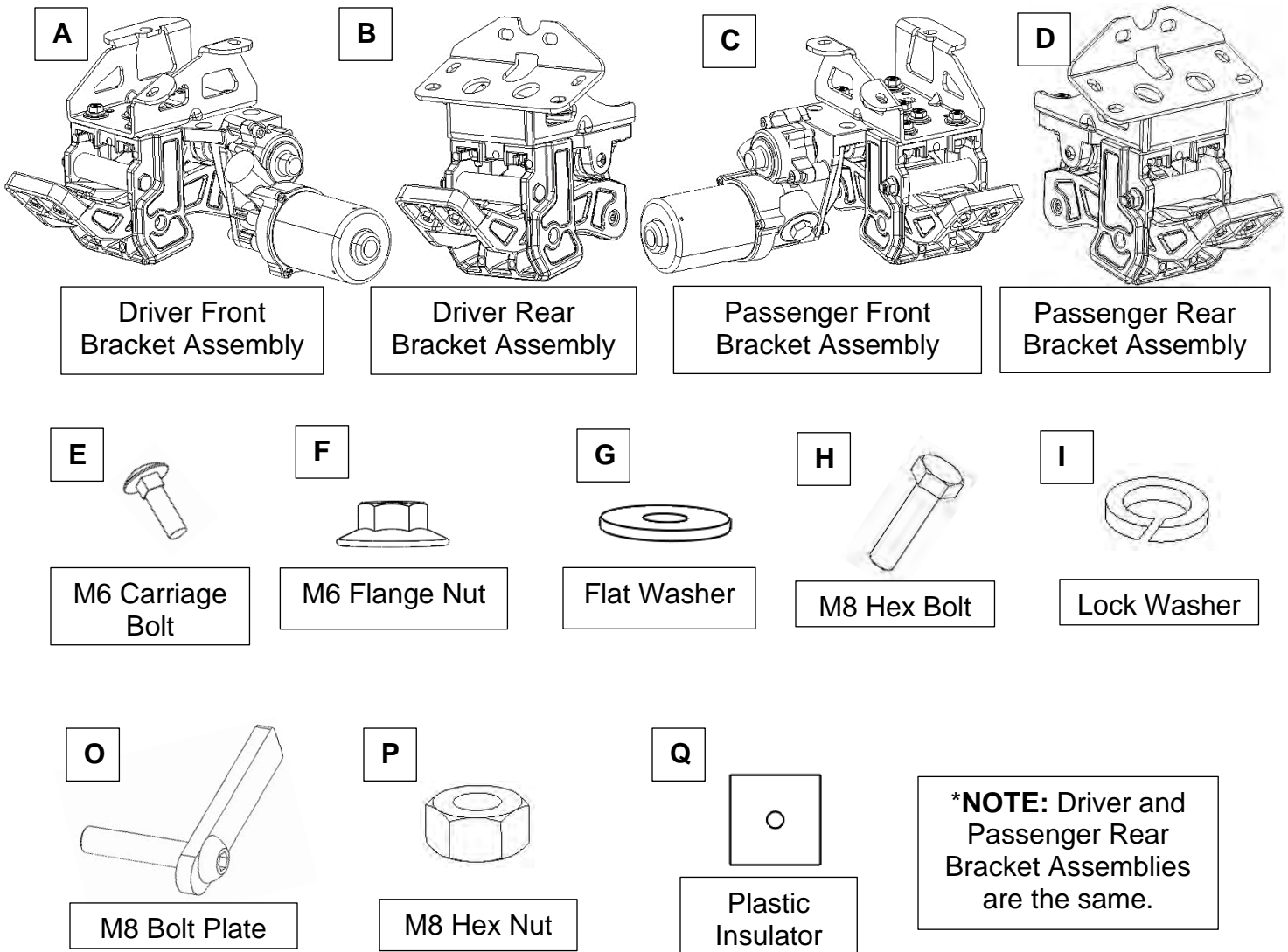

10-24 4RUNNER (Excl. 10-23 Limited & 19-22 Nightshade Edition or models with Lower Rocker Panel Extensions)



Main Harness

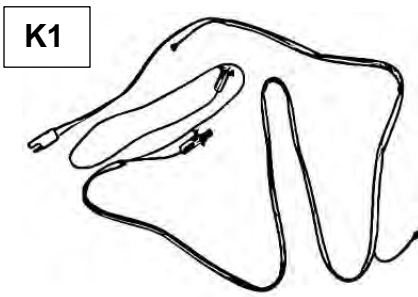

LED Y-Harness (Long)

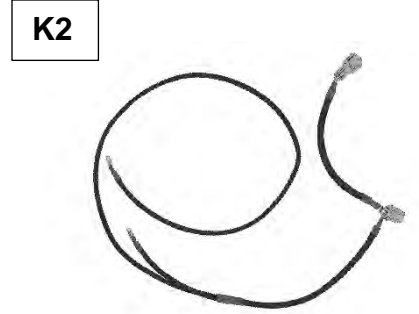

LED Y-Harness (Short)

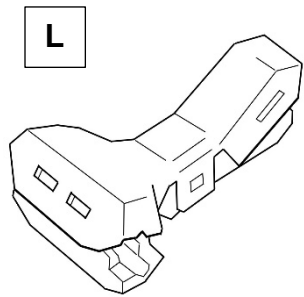

Wire Taps

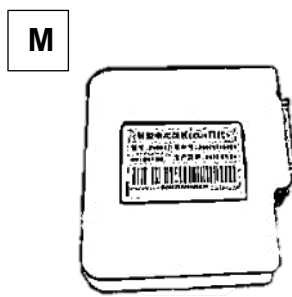

ECU

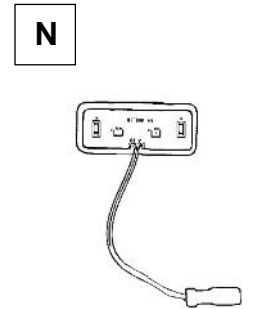

LED Lights

TOOLS REQUIRED



Ratchet



8mm
10mm
13mm

Socket



Extensions



Wrench

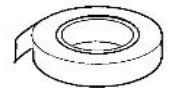

Electrical Tape

- 1 Start from the engine compartment by opening the front hood of the vehicle. Locate the Battery and its terminals (positive/negative). Remove the 25A fuse from the fuse box that comes with the main harness (J).

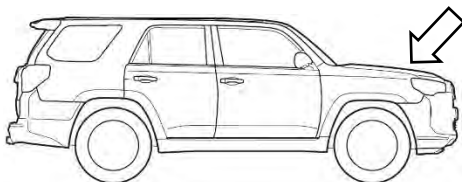

***WARNING:** Keeping the fuse connected to the fuse box may result in electrical sparks and risk of shorting when working with the battery.

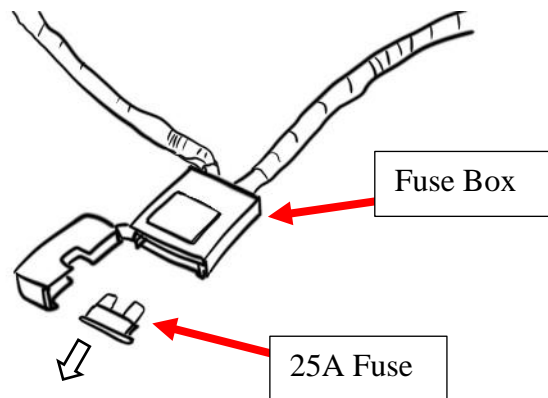

2

10-24 4RUNNER (Excl. 10-23 Limited & 19-22 Nightshade Edition or models with Lower Rocker Panel Extensions)

Connect the positive power lead on the main harness (J) to the positive battery terminal. Connect the negative lead to the negative battery terminal.

Make sure both power leads are fully secured.

Connect the ECU (M) to the main harness.

Connect the Long LED Y-Harness (K1) to the Driver-side branch of the main harness.

Connect the Short LED Y-Harness (K2) to the Passenger-side branch of the main harness.

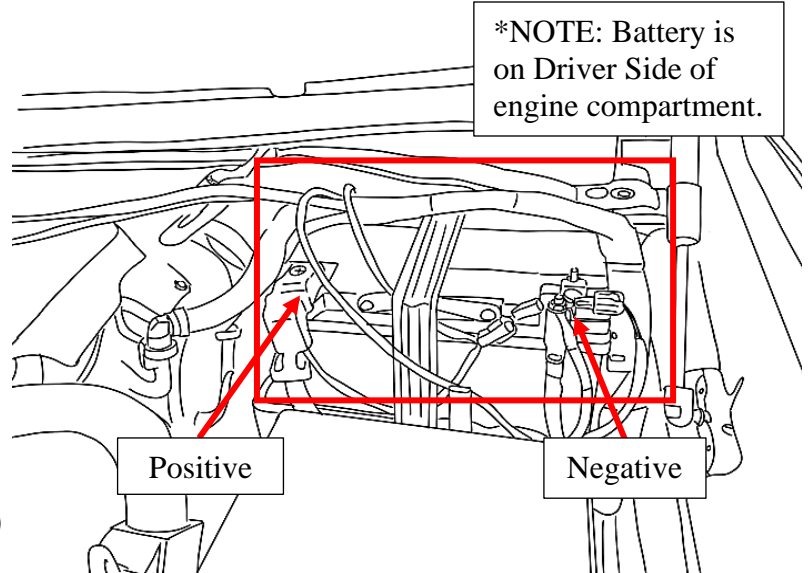

3

Route the main harness (J) around the battery, up along the rear of the engine compartment. The longer Driver-side branch of the main harness must route down the backside, against the fire wall, and down past the steering column towards the vehicle frame. **Be sure to avoid contact with the steering column.**

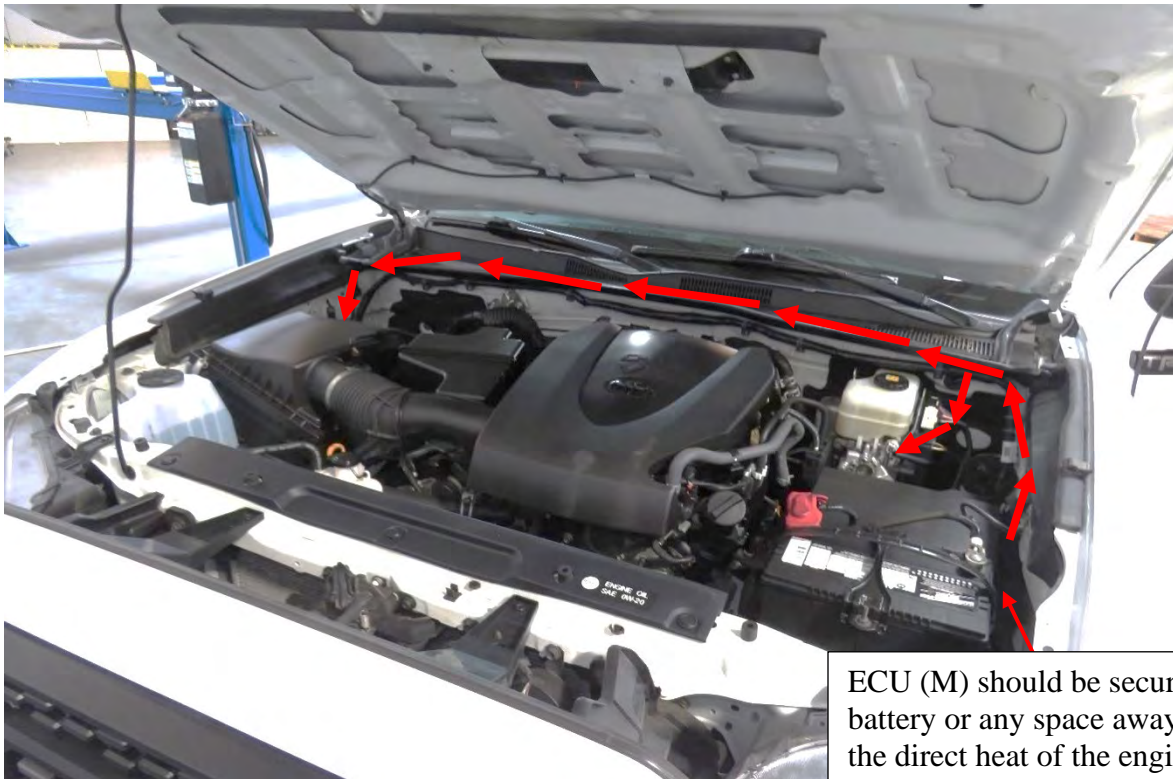

Route the shorter (marked "Passenger-side") leg of the harness down the Passenger-side wheel well. **Be sure to avoid contact with any moving or hot engine components.** Attach and secure the main harness (J) with supplied cable ties.

Be sure the harness avoids contact with the suspension and steering column.

4

10-24 4RUNNER (Excl. 10-23 Limited & 19-22 Nightshade Edition or models with Lower Rocker Panel Extensions)

Inside the vehicle cabin, remove the bottom door sill panel and then the driver-side front kick panel. Peel back the carpet to access the hole with a removeable grommet. This is the hole where the signal wires from the Main Harness (J) will need to feed through.

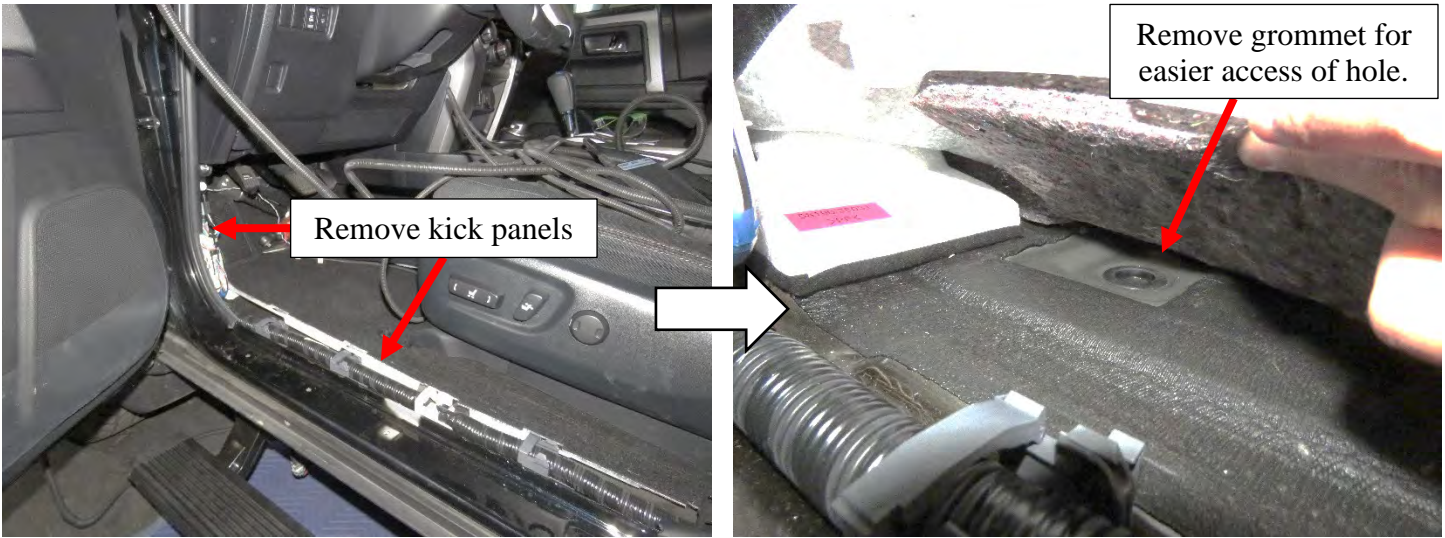

5

On the underside of the driver side, locate and remove the floor grommet in the floor panel above the frame. The grommet will be in a tight space above the frame and OE conduit. Poke a hole through the grommet and thread the two signal wires through and up into the vehicle cabin.

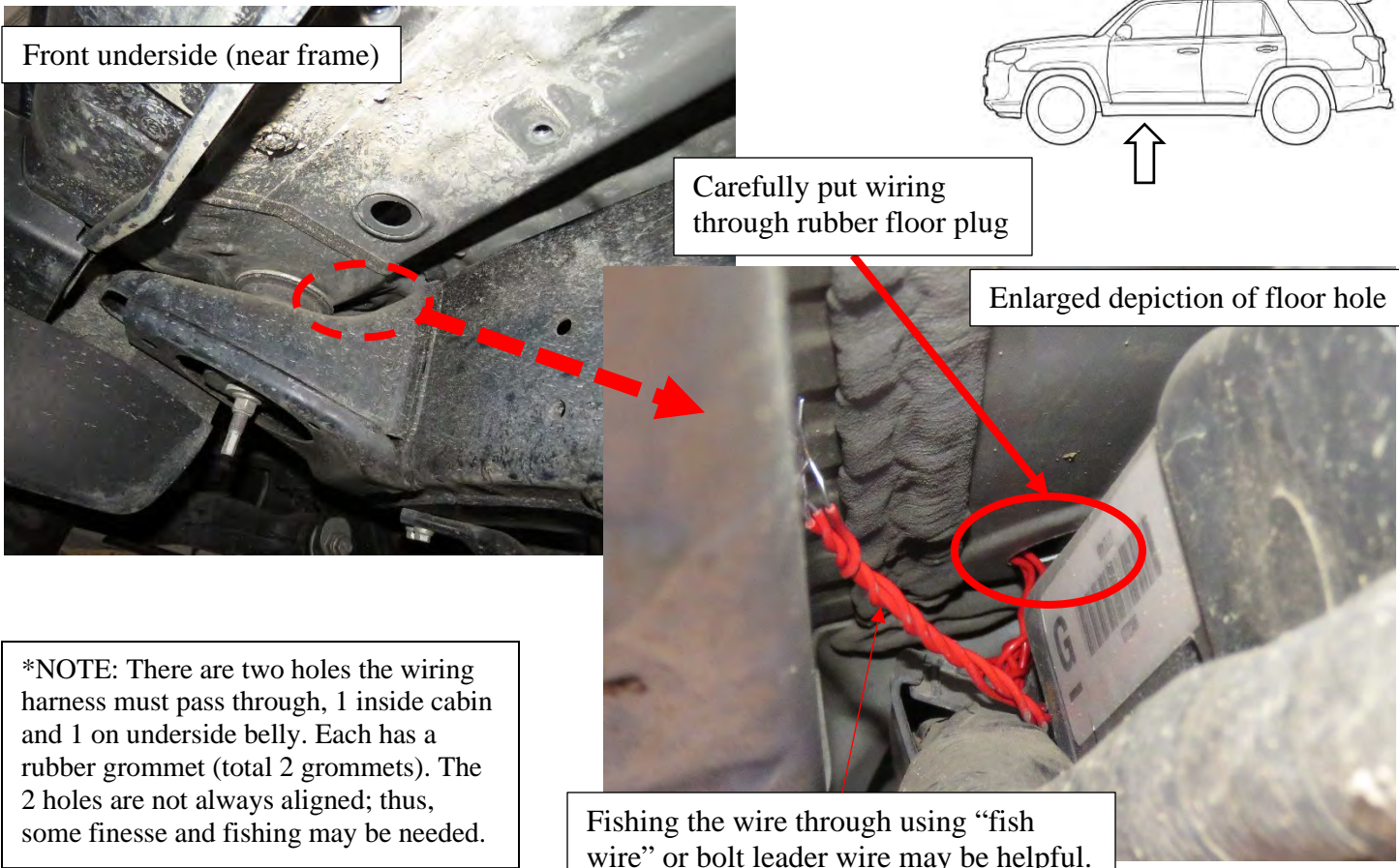

*NOTE: There are two holes the wiring harness must pass through, 1 inside cabin and 1 on underside belly. Each has a rubber grommet (total 2 grommets). The 2 holes are not always aligned; thus, some finesse and fishing may be needed.

6

10-24 4RUNNER (Excl. 10-23 Limited & 19-22 Nightshade Edition or models with Lower Rocker Panel Extensions)

Locate the white OEM CAN Junction connector under the steering wheel, behind the kick panel. Be sure vehicle is not powered on. Locate the large bundled harness of wires on the backside of the junction (top of the stack of connectors). There should be several pairs of twisted colored wires in the wire harness bundle.

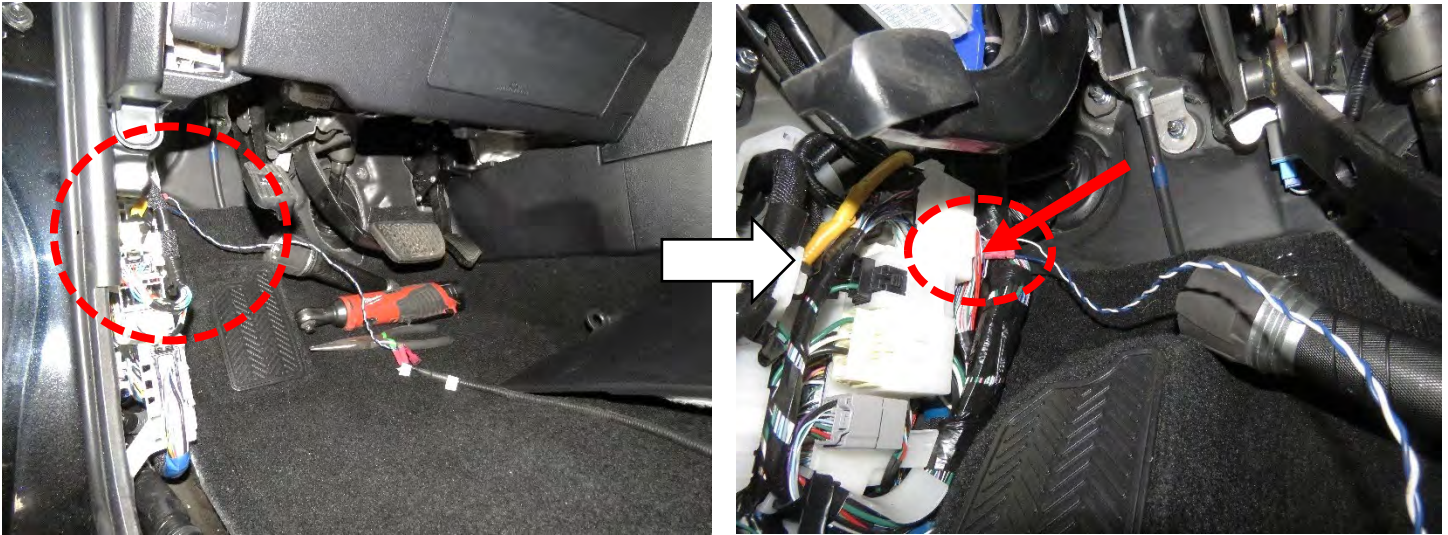

On the white connector, identify the **twisted** pair of Purple and White wires. Connect the High and Low wires from the main harness (J) using the supplied wire taps (L). After successfully connecting the wires, check that it is secure and hidden away.

Example of twisted pair being on the front of the connector hub instead of the rear. Location depends on model year.

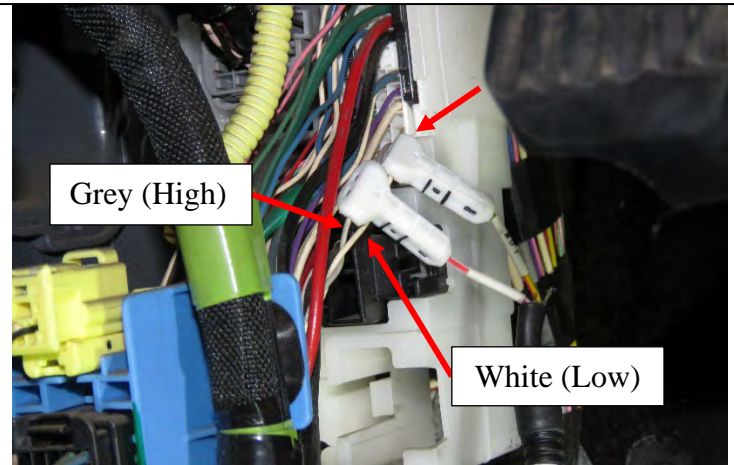
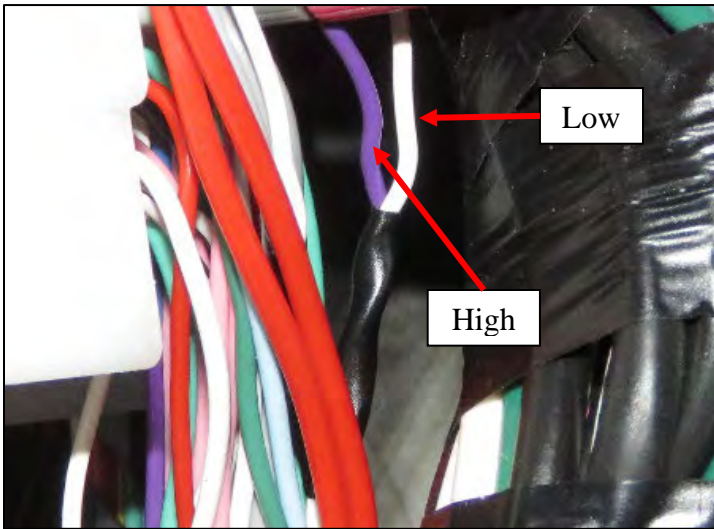

Factory CAN Wire/ Data Line	Power Step Main Harness Wire Color
Purple (High)	White (CAN-H)
White (Low)	Yellow (CAN-L)

*NOTE: Depending on the year of make, the colors of the wires may be different. In these cases, the white wire of the twisted pair is always "CAN Low".

If possible, avoid tapping the RED wires.

Wire taps supplied with kit.
Please see next page for guide.

10-24 4RUNNER (Excl. 10-23 Limited & 19-22 Nightshade Edition or models with Lower Rocker Panel Extensions)

The kit comes supplied with wire taps called "shark taps". Follow the guide below to tap the wire using the "shark tap":

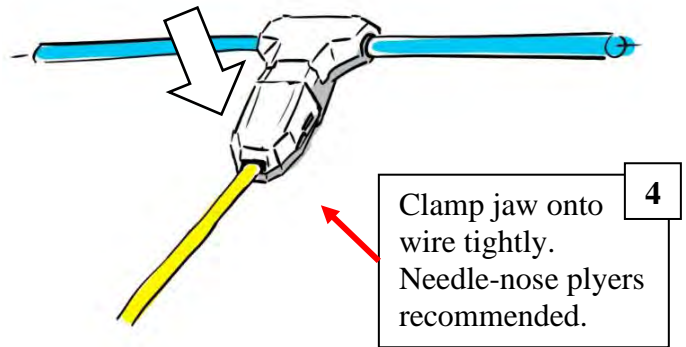
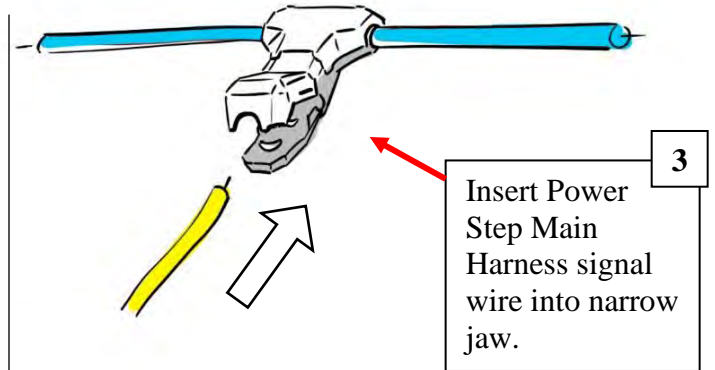
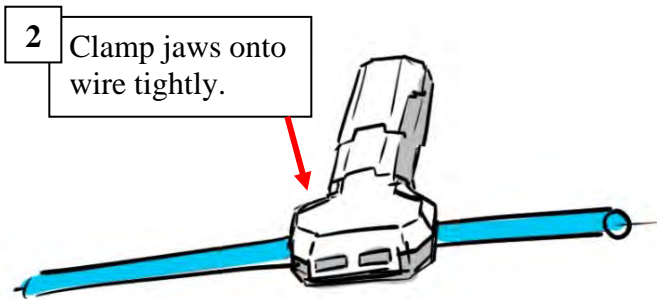
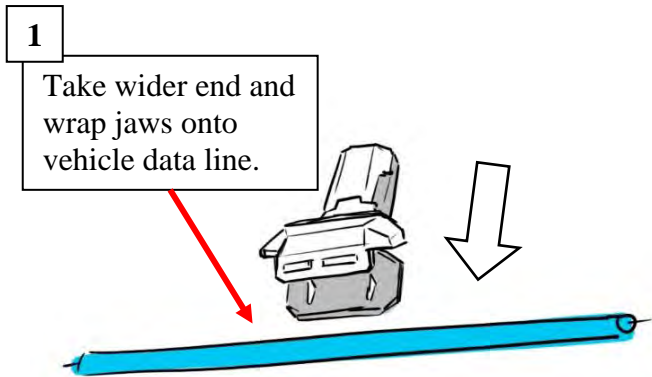

NOTE: Make sure wire is seated properly in the jaws before clamping. The wire being tapped must be centered on the "teeth" to make a proper tap.

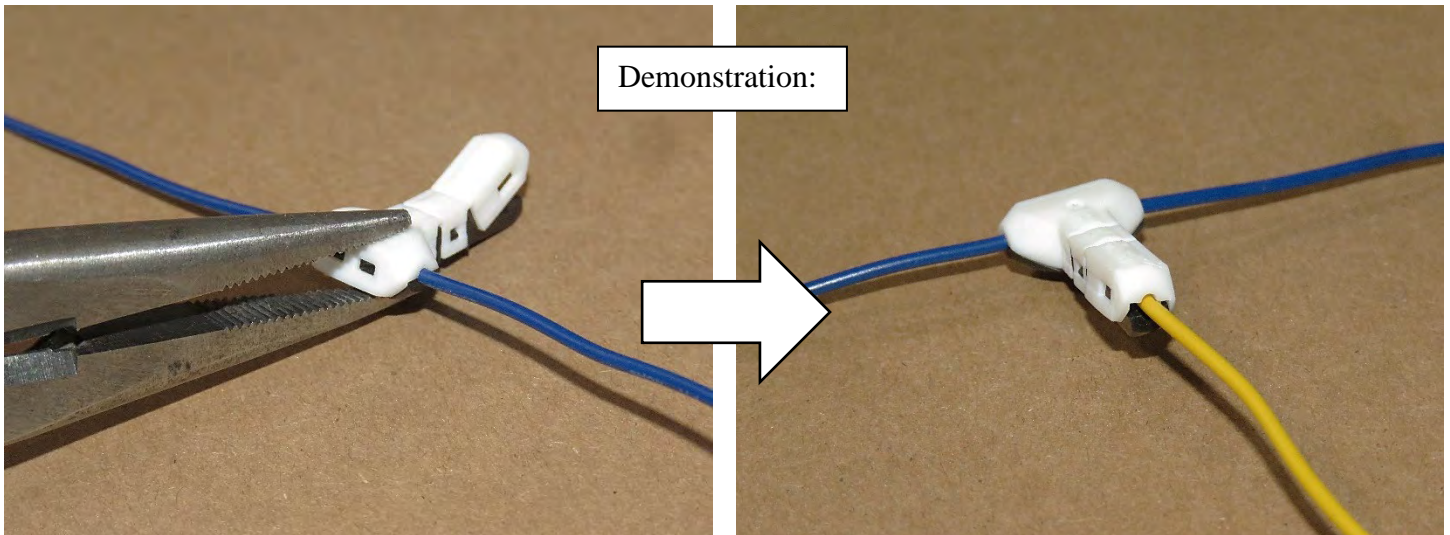

7

10-24 4RUNNER (Excl. 10-23 Limited & 19-22 Nightshade Edition or models with Lower Rocker Panel Extensions)

Locate Driver Side front mounting points on the rocker panel under the front door. Remove the OE bolts and appropriate rubber plugs before mounting the front bracket.

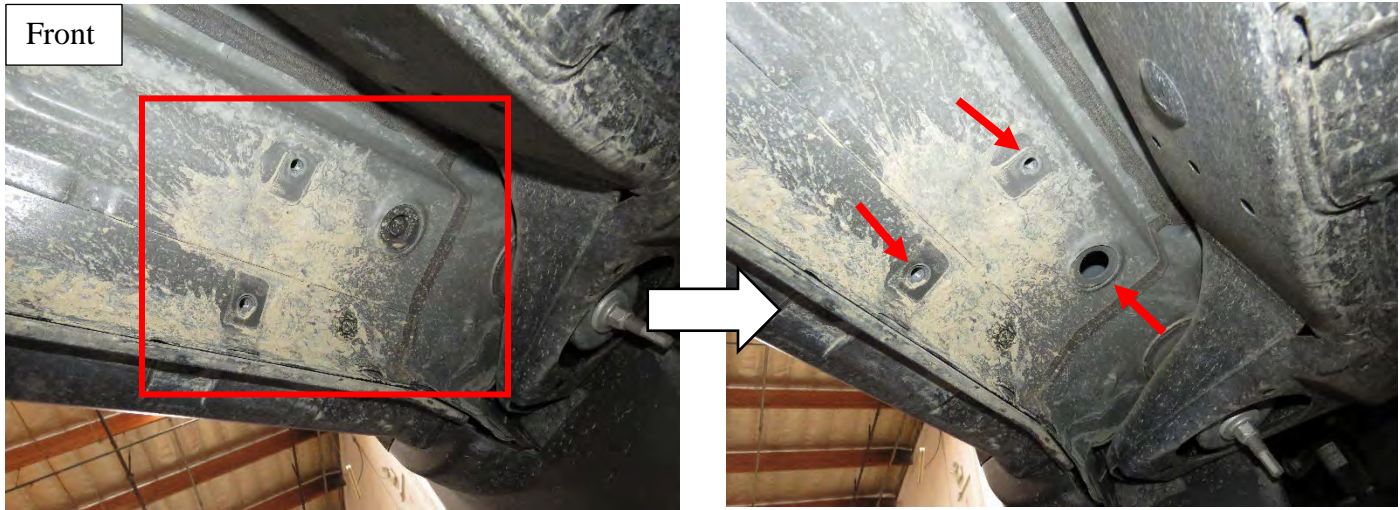

8

Next, take a Bolt Plate (O) and insert it into the large hole where the rubber plug was. Once the bolt plate sits in the hole with the threaded end stick out, use a Plastic Retainer (Q) to help the Bolt Plate (O) stay in place.

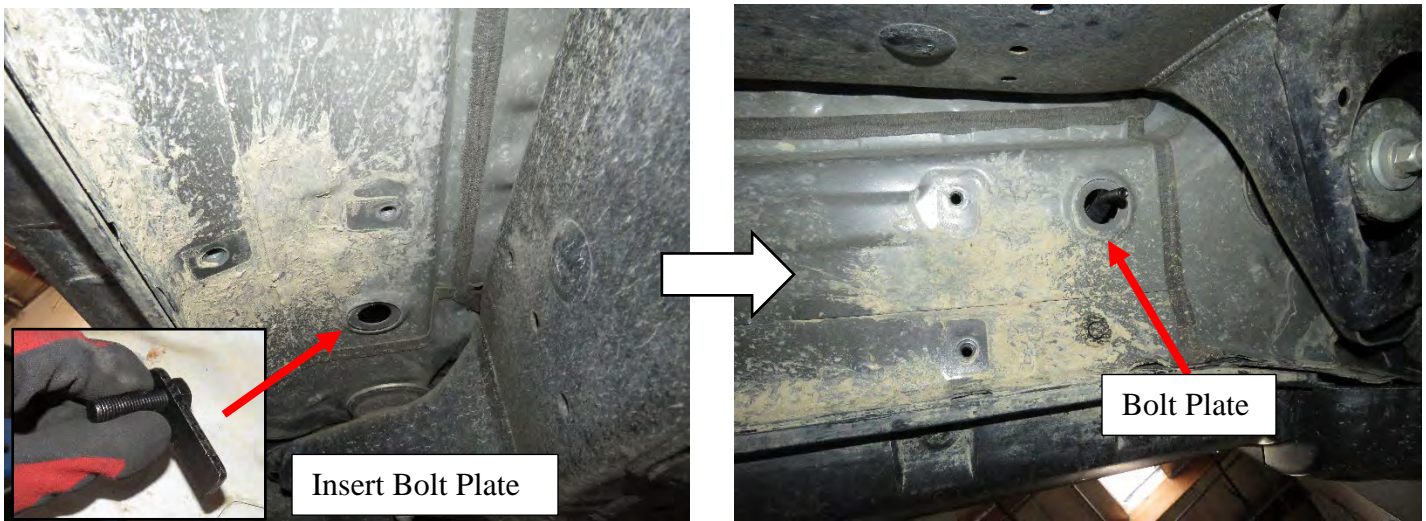

9

Locate Driver Side rear mounting points on the rocker panel. Remove the OE bolts and appropriate black sticker before inserting the bolt plate (O).

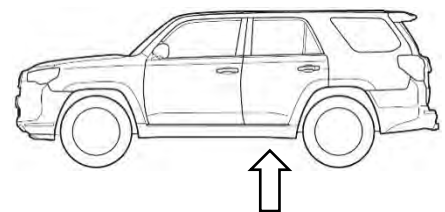
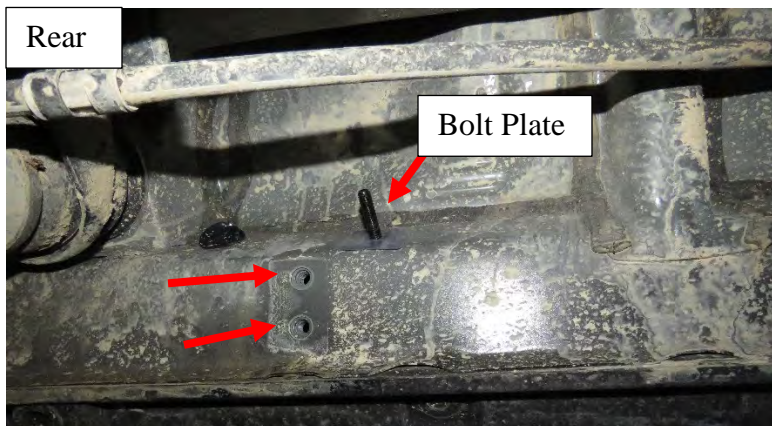

10

10-24 4RUNNER (Excl. 10-23 Limited & 19-22 Nightshade Edition or models with Lower Rocker Panel Extensions)

Next, line up front mounting bracket slots to the threaded inserts and place Driver Side/Left Front Bracket Assembly (A) onto rocker panel. Then fasten Hex Bolts (H), Lock Washers (I), Hex Nut (P), and Flat washers (G). Do not tighten all the way yet. Use the smaller Flat Washers only as indicated below.



Use smaller washers only on flanges near the motor.



Use large washer on bolt plate side.

11

Locate rear mounting points. Next, line up rear mounting bracket slots to the threaded inserts and place Driver Side/Left Rear Bracket Assembly (B) onto rocker panel. Then fasten Hex Bolts (H), Lock Washers (I), Hex Nut (P), and Flat washers (G). Do not tighten all the way yet. Use a foam strip and adhere it to the brake hose to protect it against long-term rubbing.



Use large washer on all rear mounting points.



Use foam strip on brake hose to prevent direct contact with bracket assembly.

12

Repeat steps 7 – 11 for the Passenger Side.

13 10-24 4RUNNER (Excl. 10-23 Limited & 19-22 Nightshade Edition or models with Lower Rocker Panel Extensions)

Make sure the main harness (J) and LED Y-Harness (K) are connected. Then attach the LED Y-Harness (K) to the motor on the Driver Side. Repeat for Passenger Side.

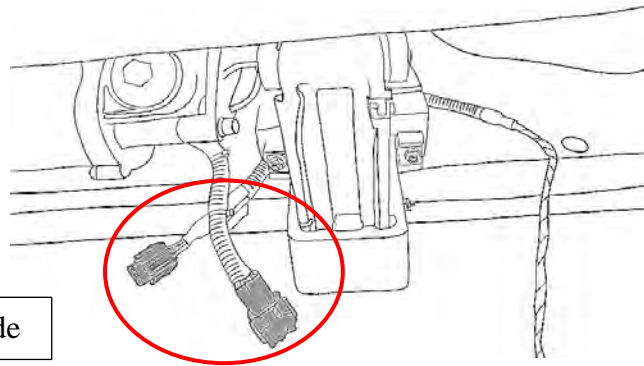

Driver side

14 Plug in LED lights (N) into LED Y-Harness (K) and attach them to the bottom of the rocker panel. Use provided 3M double sided adhesive tape on back of LED light (N). Replace Fuse into Fuse Box.

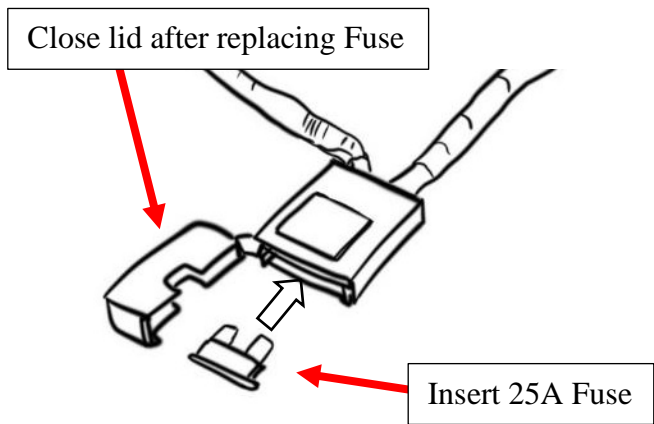
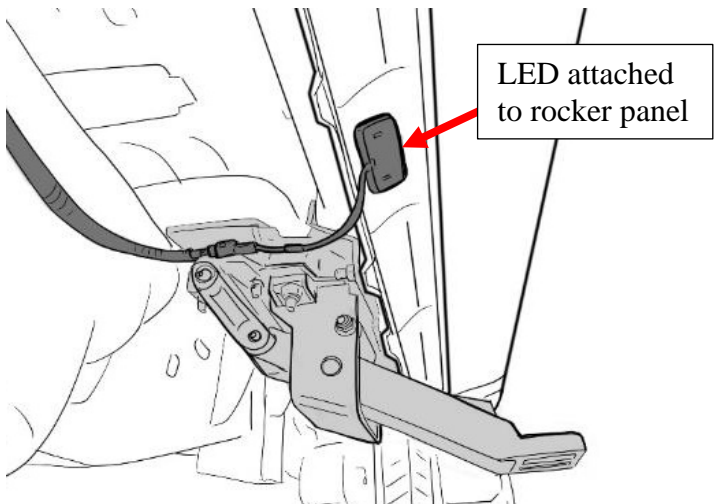

15 Check to make sure the harnesses on the Driver Side/Left Front Bracket Assembly (A) and Passenger Side Front Bracket Assembly (C) are connected to the main harness (J) via the LED-Y harnesses (K).

*NOTE: The linkage arms on the front bracket assemblies will not move unless both motors are connected.

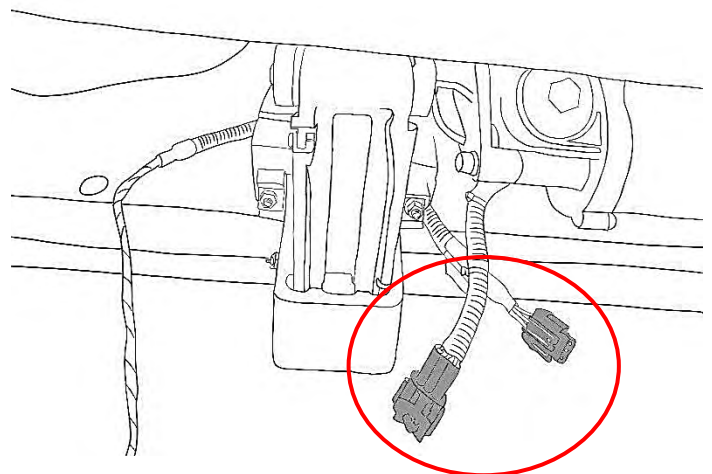

Seal the rubber boot with RTV Silicone Sealant if needed.

Hide wires and reattach the kick panel with the carpet fully unfurled in its original position. Reattach the door sill panels and check to make sure there are no obstructions or potential snag points around the brake pedal area.

Be sure to reattach plastic kick panel nut.

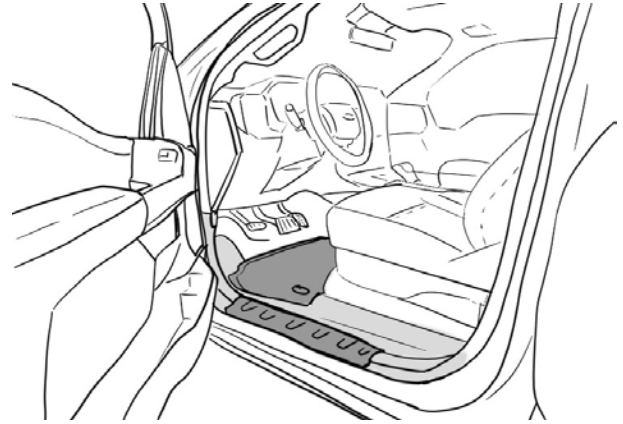

Prepare the power step boards. Locate the end of the boards and slide the M6 Carriage Bolts (E) into the channel on the underside of the board. Insert a total of 4 carriage bolts (E) for each board.

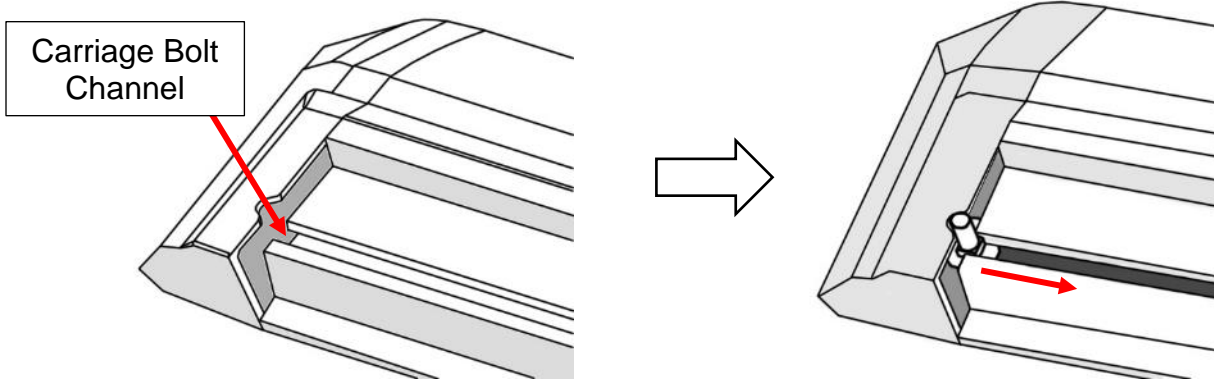

Use the notch in the board's end caps to feed the bolts into the channel.

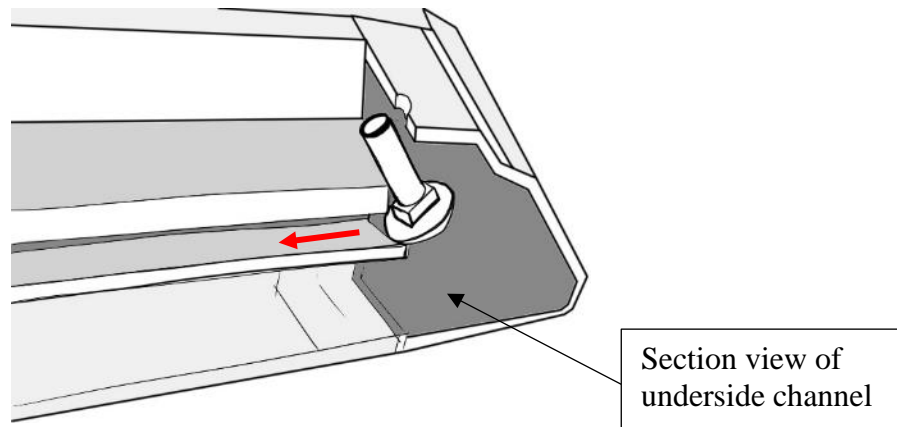

10-24 4RUNNER (Excl. 10-23 Limited & 19-22 Nightshade Edition or models with Lower Rocker Panel Extensions)

Perform a function check by closing the driver side front door and opening it again. The front bracket assembly (A) motor should activate the linkage arm and move it into the down or “deployed” position.

After deploying linkage arms, unplug main harness connector while front door is open to hold the board in the deployed position for running board installation.

Line up the carriage bolts (E), under the power step boards, with the slots on the linkage arms (A & B). Insert the 4 carriage bolts (E) into the slots on front and rear linkage arms. Adjust board to desired position. Moderately hand tighten the flange nuts (G) onto the carriage bolts.

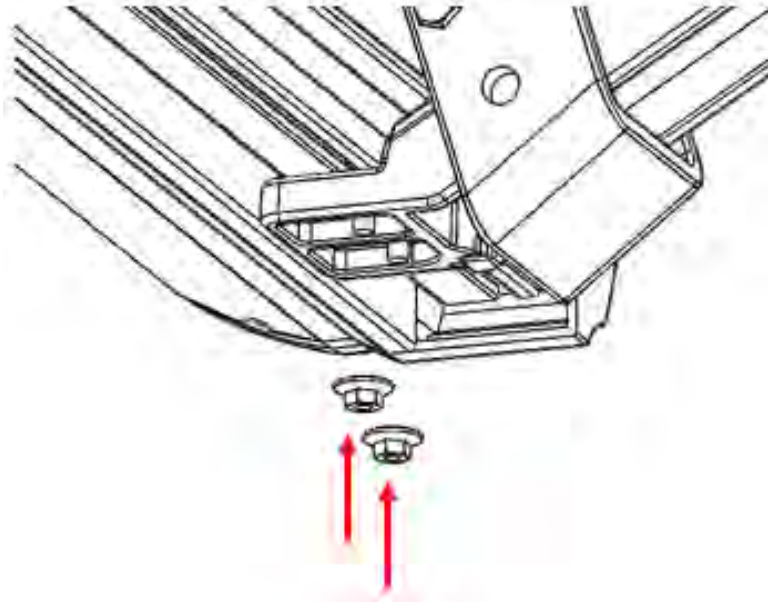

Once the board is adjusted, plug in main harness (J) connector to return power to the linkage arms. Open and close doors several times to deploy and retract the steps to settle the steps into their natural alignment. After cycling the step, tighten all hardware on the board and brackets.

Some further adjustment may be required for desired step position. Repeat for passenger side.

Perform system check and troubleshooting. If board is making irregular movements or noise, readjust the boards as follows:

- a) With board deployed loosen 6mm flange nuts under board.
- b) Leave the flange nuts slightly less than snug.
- c) Open and close door several times for board to settle into position.
- d) With the step in the deployed position, gradually tighten flange nuts while alternating between each. Do not over tighten.

If board is making abnormal noise or the motion is binding, repeat steps “a” through “d”.

Note: If the above method does not resolve the issue, the brackets mounting to the vehicle may not be aligned properly with the vehicle. In this case, remove the board and realign brackets before attempting steps “a” to “d” once again.

21 Reinstall any remaining trim panels if necessary. Check and make sure all hardware is fully tightened. Perform a final system check. Finish.



*NOTE: If board does not move during troubleshooting, check the tapped CAN Signal High and Low wires.