



INSTALLATION INSTRUCTIONS
BLACK ATLAS ROLL BAR FOR 2005-2020 TOYOTA TACOMA
PART # ATRB6BK

Before Installation









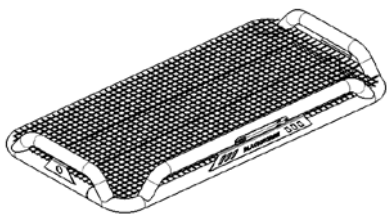
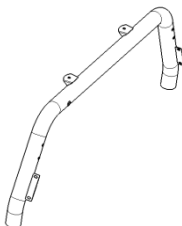
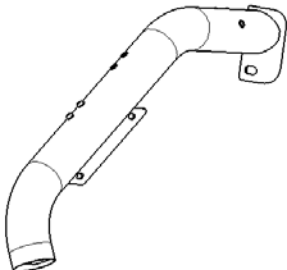
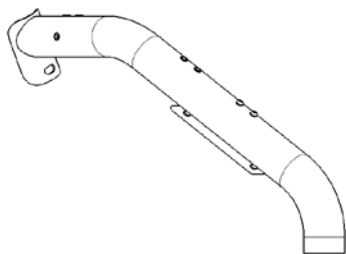
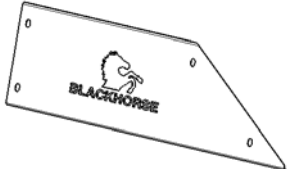
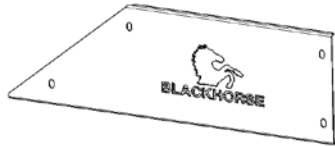
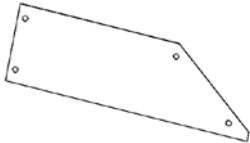
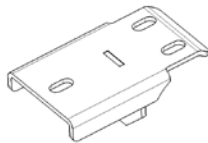

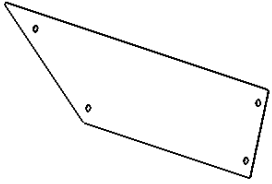

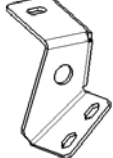

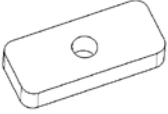
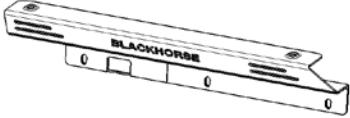

- Please read the instruction completely for easy installation, which will also help you to avoid scratches or other potential damages to your appealing car.
- The figures here are for reference only and may have differences with the actual product you received, however they share the same assembly way.



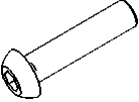



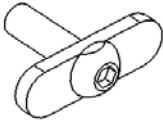

Care and Cleaning

- Mild soap may be used also to clean the Product.
- Please periodically check and retighten all the hardware and clean the investment for a refresh look.

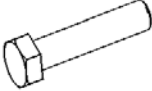
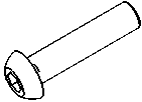
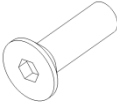
Parts list

NO.	QTY	NAME	NO.	QTY	NAME
①	1	 Luggage frame (with LED light)	②	1	 Main tube 1
③	1	 Side tube-L	④	1	 Side tube-R
⑤	1	 Decoration plate-L	⑥	1	 Decoration plate-R
⑦	2	 Red decoration plate	⑧	2	 Connect bracket 1

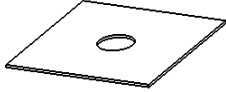
⑨	2		⑩	2	
		Decoration plate backboard			Rubber plug
⑪	1		⑫	1	
		Connect bracket 2-L			Connect bracket 2-R
⑬	1		⑭	2	
		Connecting plate			Block
⑮	1		⑯	1	
		L-bracket			R-bracket
⑰	4		⑱	8	
		Gum cover			Flat washer D6
⑲	8		⑳	8	
		Button head allen bolts M6_20			Hex nut M6
㉑	2		㉒	8	
		Button head allen bolts M8*30			Flat washer D8
㉓	14		㉔	6	
		Hex bolt M8*25			Hex nut M8
㉕	2		㉖	8	
		Spring washer D8			Flat washer D10

<p>②⑦</p>	<p>6</p>	 <p>T-Hex nut M10_35</p>	<p>②⑧</p>	<p>6</p>	 <p>Hex nut M10</p>
<p>②⑨</p>	<p>8</p>	 <p>Spring washer D10</p>	<p>③⑩</p>	<p>2</p>	 <p>Hex nut M10_25</p>
<p>③①</p>	<p>2</p>	 <p>Button head allen bolts M12_40</p>	<p>③②</p>	<p>4</p>	 <p>Flat head allen bolts M12_40</p>
<p>③③</p>	<p>2</p>	 <p>Flat washer D12</p>	<p>③④</p>	<p>1</p>	 <p>Allen wrench S=8</p>
<p>③⑤</p>	<p>1</p>	 <p>Allen wrench S=4</p>	<p>③⑥</p>	<p>1</p>	 <p>Allen wrench S=5</p>
<p>③⑦</p>	<p>6</p>	 <p>PVC</p>	<p>③⑧</p>	<p>5</p>	 <p>Black adhesive tape</p>

Installation Steps

Step1: Assemble tubes with standard parts. Lock all the standard parts after adjust the position.

Use standard parts (10) (31)

(33) to connect (2) (3).

Installation are same at both sides.

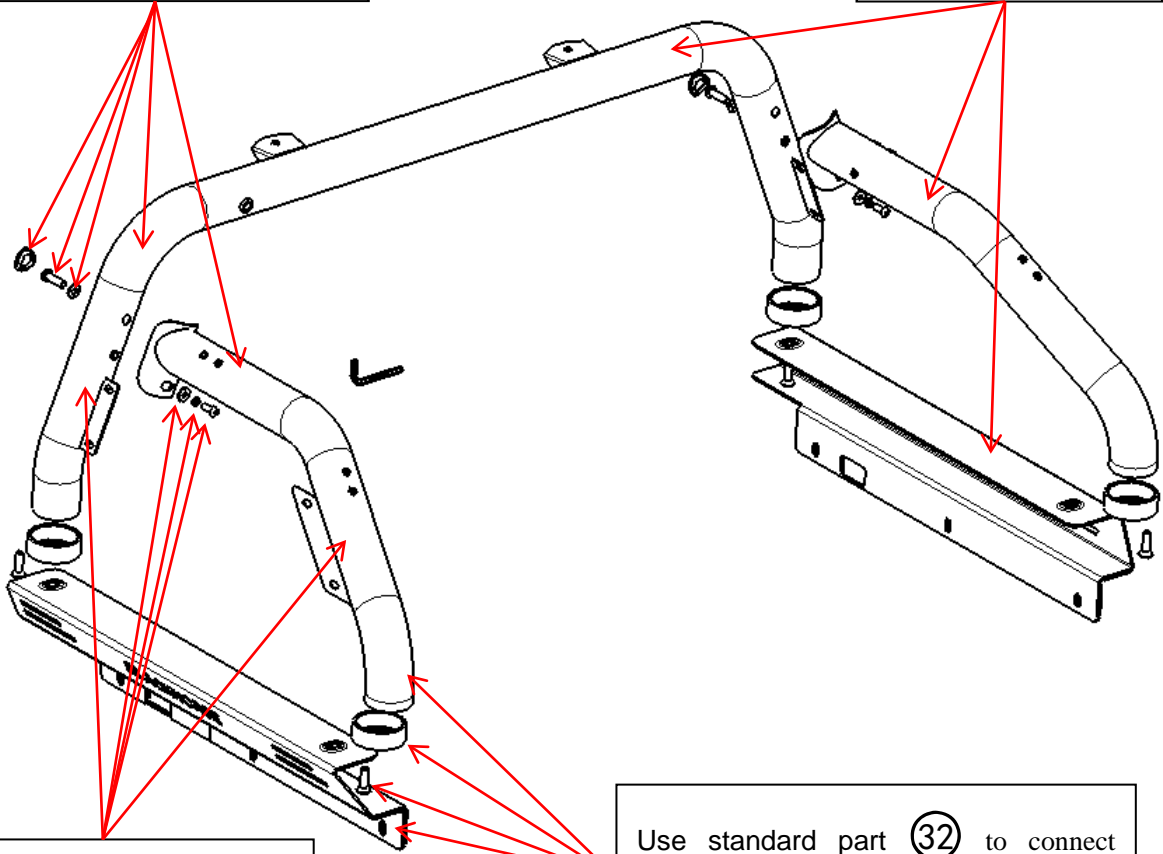

Use standard parts (26) (29)

(30) to connect (2) (3).

Use standard part (32) to connect

(15) (17) on tube.

Step2: Assemble Luggage frame and tubes with standard parts. Lock all the standard parts after adjust the position.

Use standard parts (21) (22) (24) (25) to connect (13) (14) on the tubes. 2 places.

Use standard parts (22) (23) (24) to connect (1) on the tubes. 4 places.

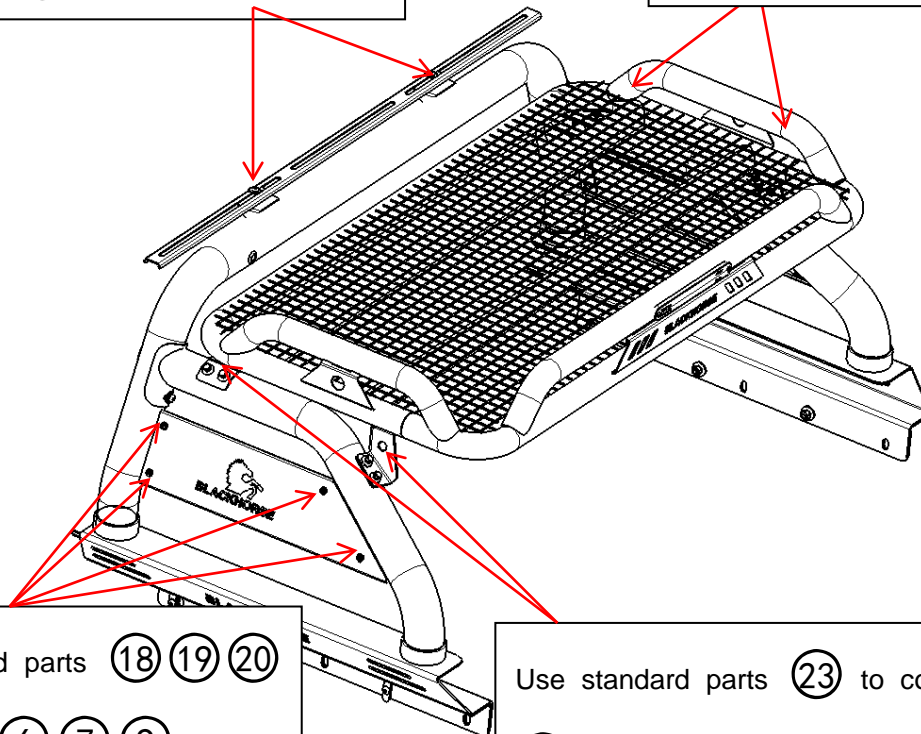

Use standard parts (18) (19) (20) to connect (6) (7) (9) on the tubes. 8 places.

Use standard parts (23) to connect (8) (11) (12) on the tubes. 8 places.

Step3: Put roll bar on the truck in an appropriate place. And use pen to mark the holes. 3 places in each part, 6 places total. Remove the roll bar then drill the size of $\Phi 12$ holes. Put the roll bar back and use standard (26) (27) (28) (29) (37) to fasten.

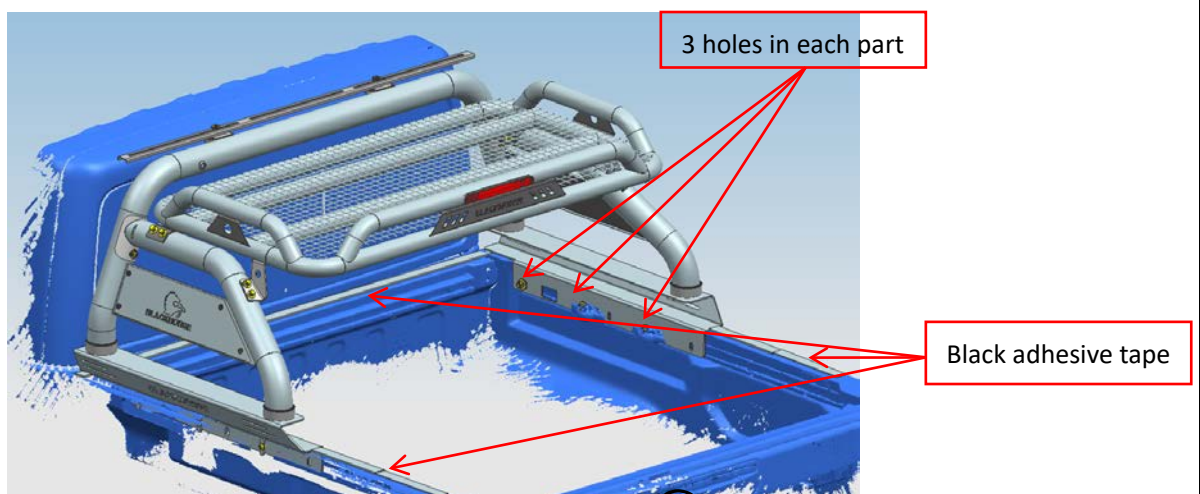

Notice: If compatible with tonneau cover, pls sticker the black adhesive tape (38) on the truck rail to full fill the gap as the picture shown.

NOTE

Any damages and losses caused by improper installation and application, goes beyond our quality warranty.