

BLACK MODULAR UNIVERSAL ROLL BAR FOR 1/2 TON TRUCKS (GM SILVERADO 14+/FORD F150 15+/DODGE RAM 15+) WITH FULL SIZE CARGO BASKET(WITH RED BRAKE LIGHT)



## **INSTALLATION INSTRUCTIONS**

**BLACK MODULAR UNIVERSAL ROLL BAR FOR 1/2 TON TRUCKS (GM SILVERADO 14+/FORD F150 15+/DODGE RAM 15+) WITH FULL SIZE CARGO BASKET(WITH RED BRAKE LIGHT)**

**PART # WRB-001BK**



### Before Installation

- Please read the instruction completely for easy installation, which will also help you to avoid scratches or other potential damages to your appealing car.
- The figures here are for reference only and may have differences with the actual product you received, however they share the same assembly way.

### Care and Cleaning

- Mild soap may be used also to clean the product.
- Please periodically check and retighten all the hardware and clean the investment for a refresh look.

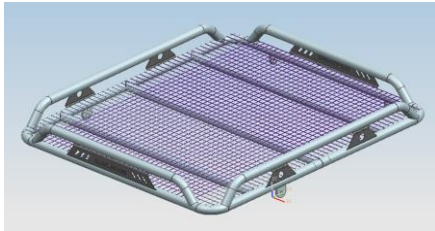

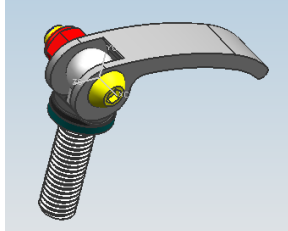
### Parts list

NO.	QTY	PICTURE	NO.	QTY	PICTURE	NO.	QTY	PICTURE
①	1		②	2		③	6	
		Luggage frame			Luggage frame bracket			M12 quick release

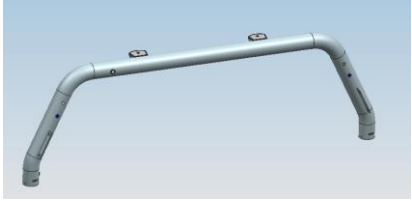
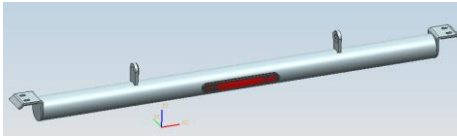
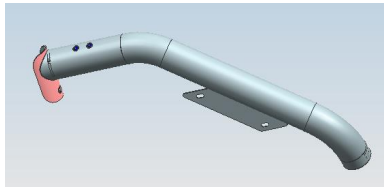
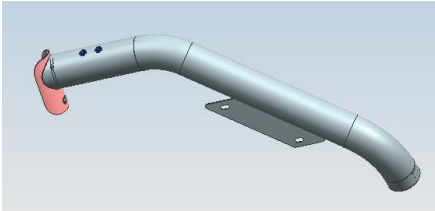
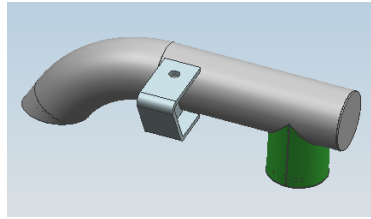
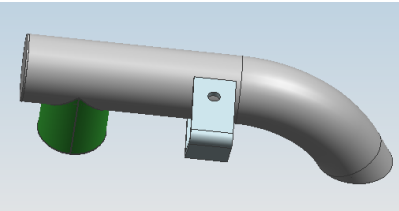
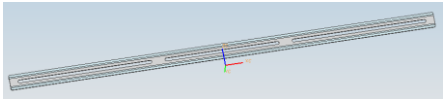
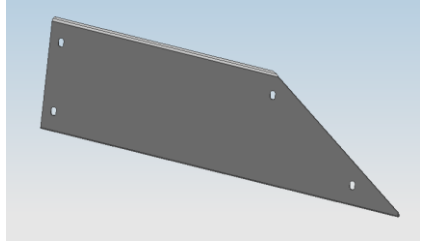
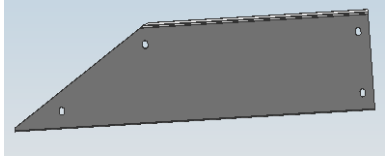
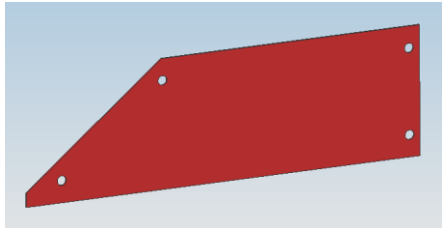
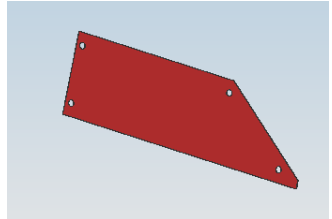
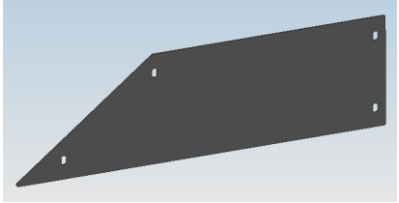
BLACK MODULAR UNIVERSAL ROLL BAR FOR 1/2 TON TRUCKS (GM SILVERADO 14+/FORD F150 15+/DODGE RAM 15+) WITH FULL SIZE CARGO BASKET(WITH RED BRAKE LIGHT)

④	1	 <p>Main tube</p>	⑤	1	 <p>Middle tube</p>	⑥	1	 <p>Side tube-L</p>
⑦	1	 <p>Side tube-R</p>	⑧	1	 <p>Short side tube-L</p>	⑨	1	 <p>Short side tube-R</p>
⑩	1	 <p>Connecting plate</p>	⑪	1	 <p>Decoration plate-L</p>	⑫	1	 <p>Decoration plate-R</p>
⑬	1	 <p>Red decoration plate-L</p>	⑭	1	 <p>Red decoration plate-R</p>	⑮	2	 <p>Decoration plate backboard</p>

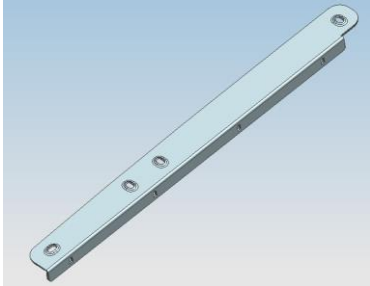
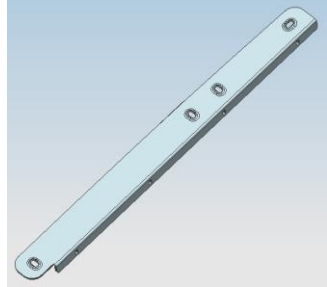
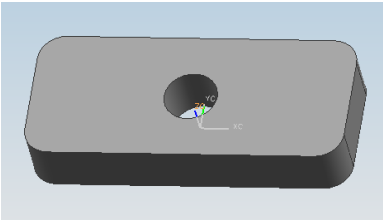
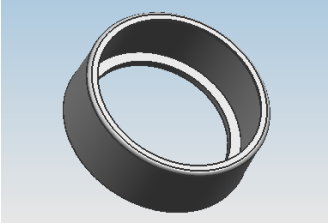
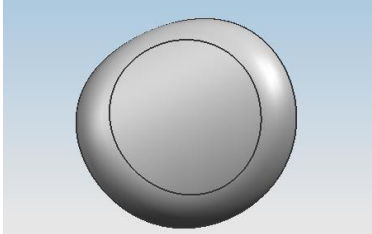
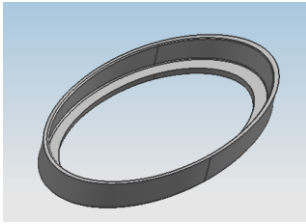
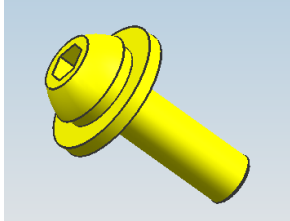
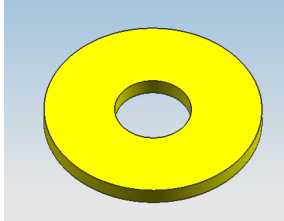
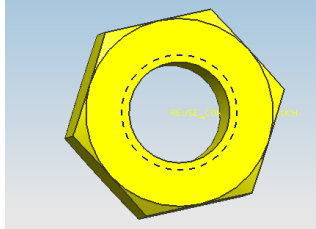
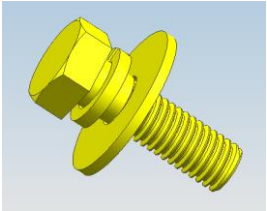
BLACK MODULAR UNIVERSAL ROLL BAR FOR 1/2 TON TRUCKS (GM SILVERADO 14+/FORD F150 15+/DODGE RAM 15+) WITH FULL SIZE CARGO BASKET(WITH RED BRAKE LIGHT)

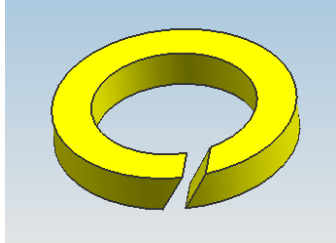
<p>①⑥</p>	<p>1</p>	 <p>L-bracket</p>	<p>①⑦</p>	<p>1</p>	 <p>R-bracket</p>	<p>①⑧</p>	<p>2</p>	 <p>Block</p>
<p>①⑨</p>	<p>6</p>	 <p>Gum cover 1</p>	<p>②⑦</p>	<p>2</p>	 <p>Rubber plug</p>	<p>②⑧</p>	<p>2</p>	 <p>Gum cover 2</p>
<p>②②</p>	<p>8</p>	 <p>Button head allen bolts M6_20</p>	<p>②③</p>	<p>8</p>	 <p>Flat washer D6</p>	<p>②④</p>	<p>8</p>	 <p>Hex nut M6</p>
<p>②⑤</p>	<p>6</p>	 <p>Button head allen bolts M8_25</p>	<p>②⑥</p>	<p>2</p>	 <p>Button head allen bolts M8_30</p>	<p>②⑦</p>	<p>2</p>	 <p>Spring washer D8</p>

BLACK MODULAR UNIVERSAL ROLL BAR FOR 1/2 TON TRUCKS (GM SILVERADO 14+/FORD F150 15+/DODGE RAM 15+) WITH FULL SIZE CARGO BASKET(WITH RED BRAKE LIGHT)

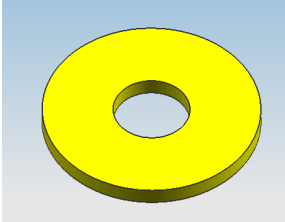
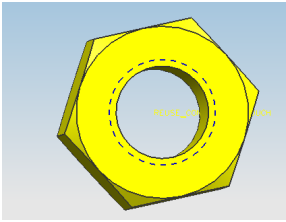
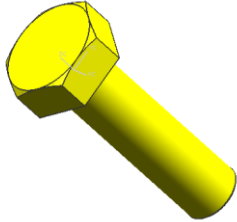
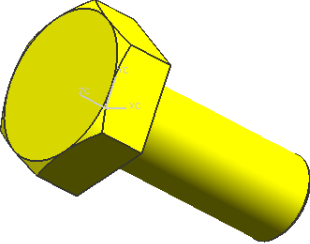
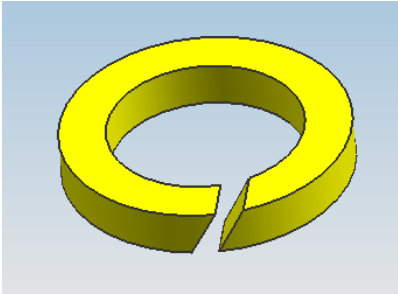
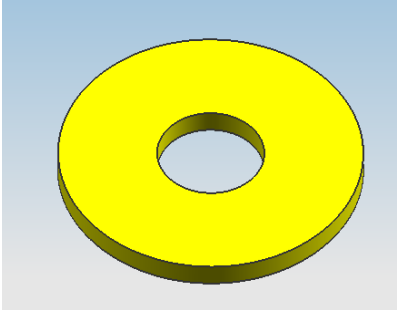
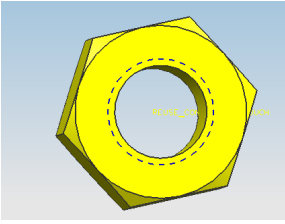
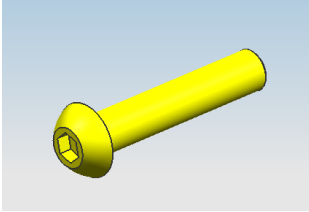
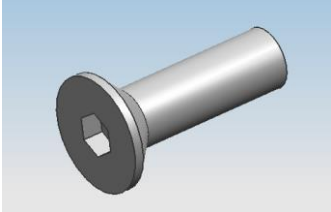
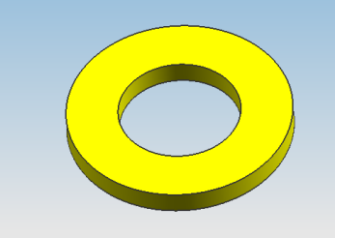
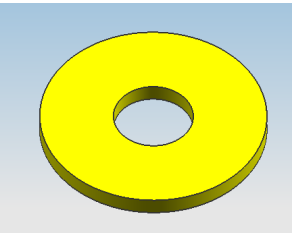
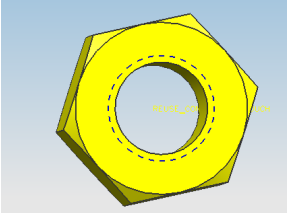
<p>②⑧</p>	<p>4</p>	 <p>Flat washer D8</p>	<p>②⑨</p>	<p>2</p>	 <p>Hex nut M8</p>	<p>③⑩</p>	<p>8</p>	 <p>Hex nut M10_35</p>
<p>③①</p>	<p>2</p>	 <p>Hex nut M10_25</p>	<p>③②</p>	<p>10</p>	 <p>Spring washer D10</p>	<p>③③</p>	<p>18</p>	 <p>Flat washer D10</p>
<p>③④</p>	<p>8</p>	 <p>Hex nut M10</p>	<p>③⑤</p>	<p>2</p>	 <p>Hexagon socket head screw M12*40</p>	<p>③⑥</p>	<p>8</p>	 <p>Hexagon socket head screw M12*40</p>
<p>③⑦</p>	<p>2</p>	 <p>Flat washer D12</p>	<p>③⑧</p>	<p>6</p>	 <p>Flat washer D12</p>	<p>③⑨</p>	<p>6</p>	 <p>Hex nut M12</p>

BLACK MODULAR UNIVERSAL ROLL BAR FOR 1/2 TON TRUCKS (GM SILVERADO 14+/FORD F150 15+/DODGE RAM 15+) WITH FULL SIZE CARGO BASKET(WITH RED BRAKE LIGHT)

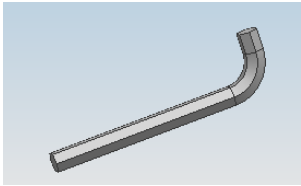
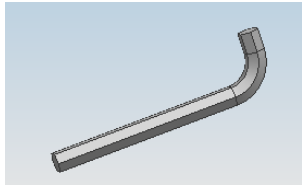
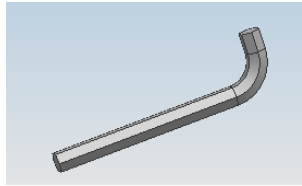
④0	1		④1	1		④2	1	
		Allen wrench S=8			Allen wrench S=4			Allen wrench S=5

Installation pictures

MR roll bar

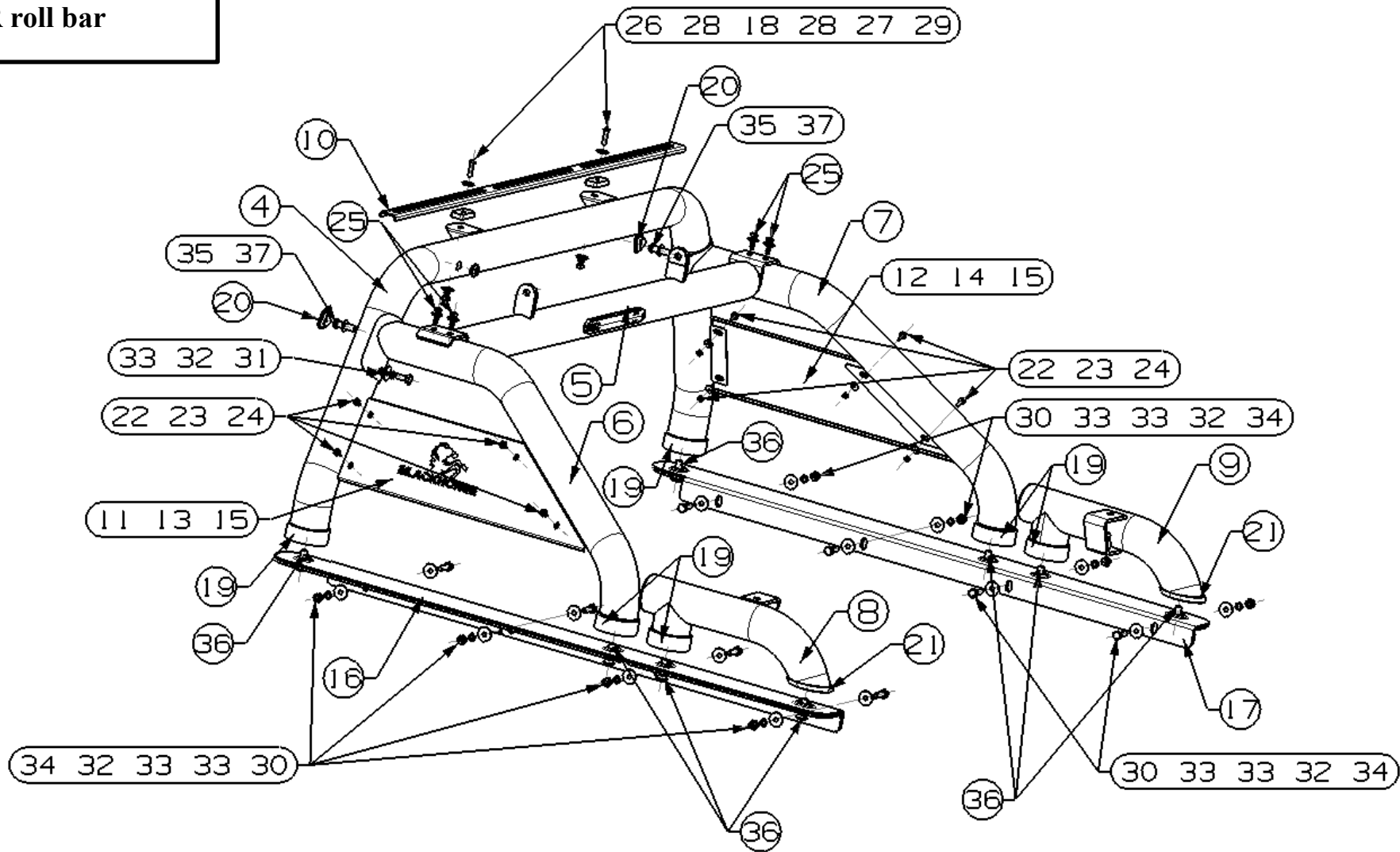

MR cargo basket

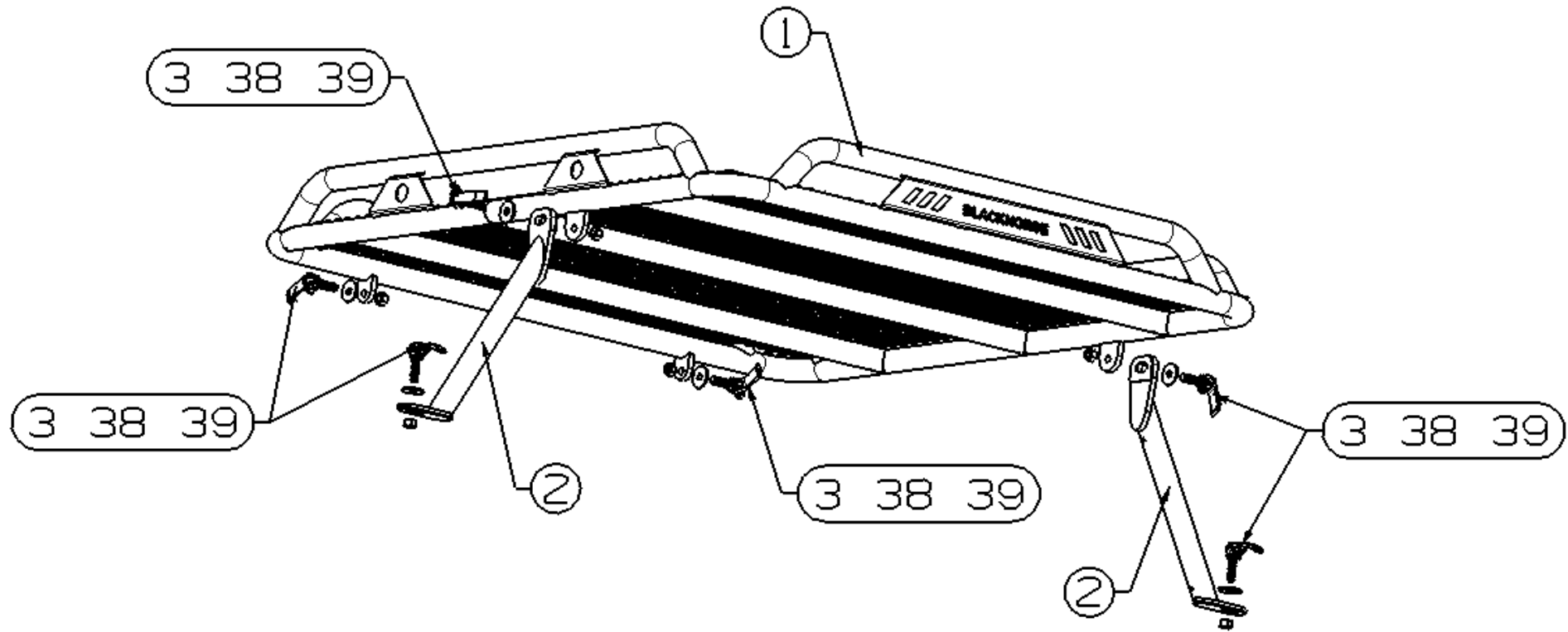



Step 1: Check all the contents are available in accordance with the above list.

Step 2: Use standard parts ③③③②③① and ③⑤③⑦ to connect ⑥⑦ with ④. Do not tighten the bolt.

Step 3: Use standard parts ②⑤ to connect ⑤ with ⑥⑦. Do not tighten the bolt.

Step 4: Use standard parts ②②②③②④ to connect ①①①③①⑤ and ①②①④①⑤ with ④⑥⑦. Do not tighten the bolt.

Step 5: As MR ROLL BAR figure shows, assemble gum covers ①⑨②① to the corresponding position.

Step 6: Place the MR roll bar and tubes ⑧⑨ on brackets ①⑥①⑦, then use standard part ③⑥ to connect. Lock all the standard parts after adjust the position.

Step 7: Put roll bar on the truck in an appropriate place. And use pen to mark the holes. Then remove the roll bar and drill the holes for installation.

Put the roll bar back and use standard ③④③②③③③③③① to fasten. .

Step 8: Use standard parts ②⑥②⑦②⑧②⑨ and block ①⑧ to connect Main tube ④ with Connecting plate ①⑩. Do not tighten the bolt.

Step 9: Use standard parts ③③⑧③⑨ to connect Luggage frame bracket ② with Luggage frame ①. Do not tighten the bolt.

Step 10: Place MR cargo basket on MR roll bar. Then use standard parts ③③⑧③⑨ to connect ⑤ and ⑧⑨. Lock all the standard parts after adjust the position.

Step 11: Assemble rubber plug ②① to Main tube ④. Check all bolts whether they have been fastened. Packing up and Installation completed.

## NOTE

Any damages and losses caused by improper installation and application, goes beyond our quality warranty.

**Assemble Pic.**

