

Hard Tri-Fold Tonneau Installation Instructions

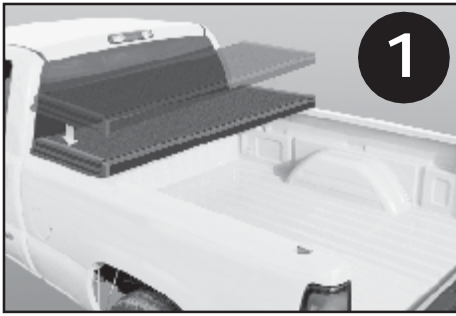

1

1. Place the cover on front of truck bed.



Place dust seal between cab and truck bed.

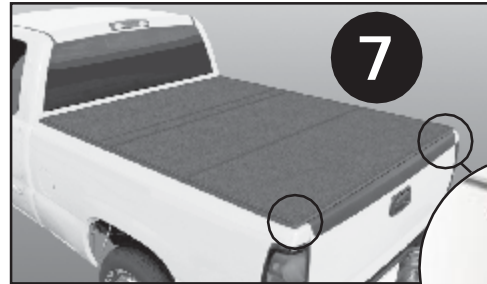

7

7. Cover is laying down flat.

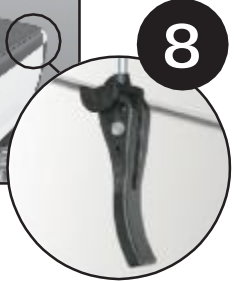

8

8a. Secure tailgate clamp hooks for a snug fit.

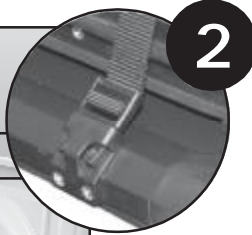
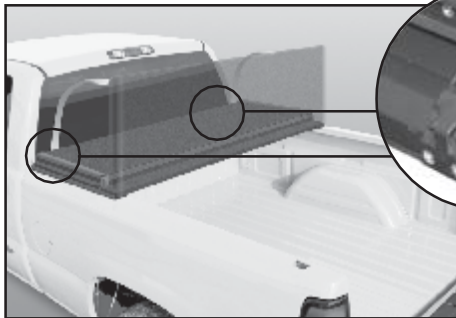

2

2. Undo both tie-down straps so cover can be unfolded.

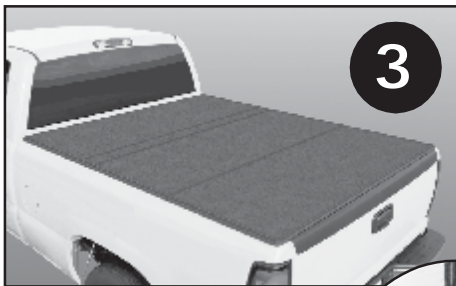

3

3. Unfold the cover all the way open to align cover on the truck bed rails before clamping.

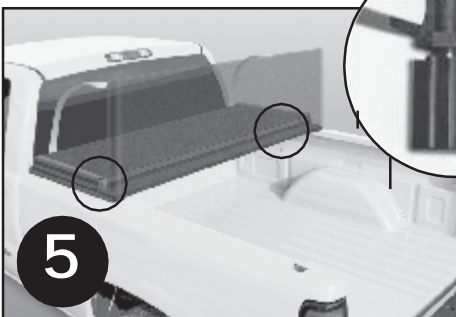

4

4. Secure cab clamp hooks under the metal bed rail. Toyota Models Only - Tighten lock nut at bottom of knob.

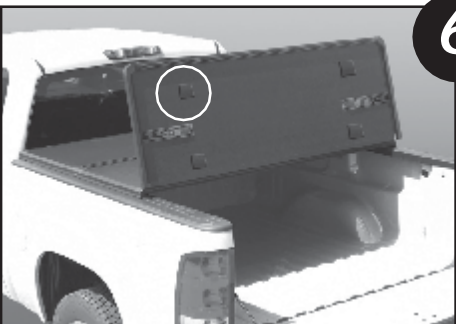

5

5. Unfold first section.

6

6. Unfold second section.

IMPORTANT
DO NOT remove foam blocks. They protect surface of panel when folding. Voids Warranty.

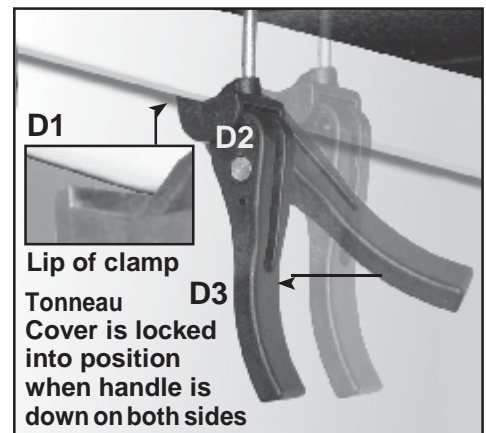

D1

D2

D3

Lip of clamp
Tonneau Cover is locked into position when handle is down on both sides

8b. To clamp cover down, put lip of clamp hooks under the side metal bed rail and push handle down. (See D1, D2, D3)



How To Adjust Clamps

To adjust, turn clamp hook clockwise to tighten or counter clockwise to loosen.

9. Vehicles With Utility Track

A. Slide aluminum blocks into track, position and tighten set-screw.

B. Secure cab and tailgate clamp hooks on to aluminum blocks.



Cab



Tailgate

10. Paint Protectors

A. Apply to inside metal bed rail at each latch location

Hard Tri-Fold Tonneau Installation Instructions

Seal Instruction

11a. For below seal you received

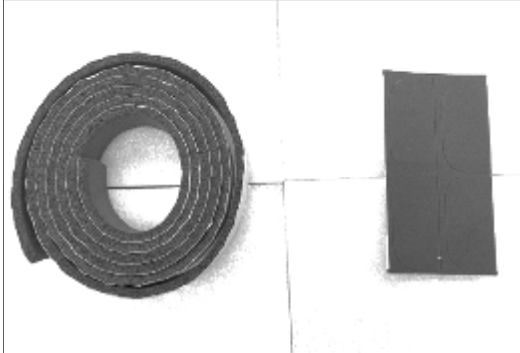

① The seal on above photo (L), put it on tailgate door. (As the photo shows below)

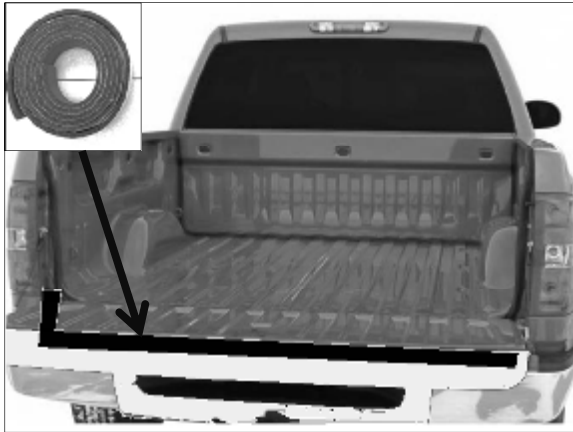

② Another seal put on the clamp to avoid any scratches happen while touching the car body.

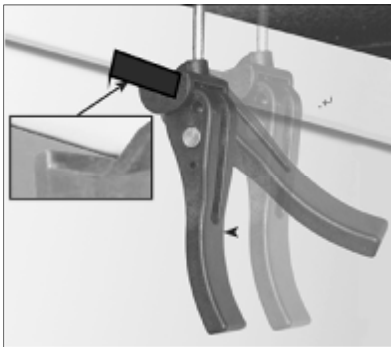

11b. For below seal you received



Put on this seal on bulkhead if it is not flat, to make the bulkhead can full contact with the tonneau cover.

12. Brackets installation

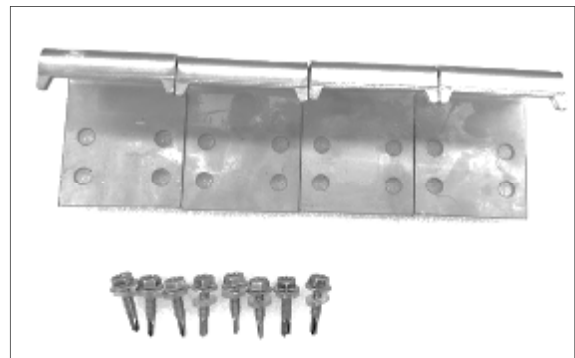

If your truck carries an over-rail type Bed Liner and you do not want to remove it, you can install these 4 brackets directly on the Bed Liner for clamping at appropriate positions. (as the figure shows below)

