

RAMBLER GRILLE GUARD FOR 21-25 FORD BRONCO



TEL: 1-866-XANATOS

INSTALLATION INSTRUCTIONS

**RAMBLER GRILLE GUARD
FOR 21-25 FORD BRONCO**

PART # RAGF20

PROTECTED BY ONE OR MORE PATENT

PART# **RAGF20****RAMBLER GRILLE GUARD FOR 21-25 FORD BRONCO****Before Installation**

- Please read the instructions completely for easy installation, which will also help you to avoid scratches or other potential damage to your appealing car.
- The information shown here is for reference only and may differ from the product that you receive, however the goods are fitted in the same way.

Care and Cleaning

- Mild soap may be used also to clean the Product.
- Please periodically check and retighten all the hardware and clean the investment for a refresh look.

Parts list

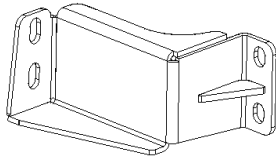
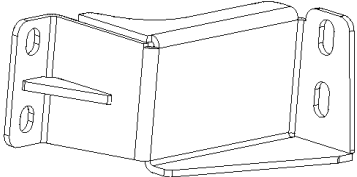
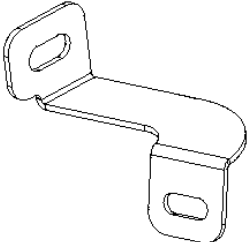
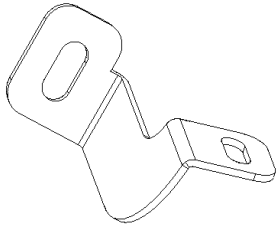
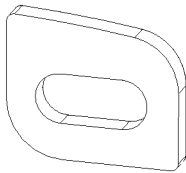
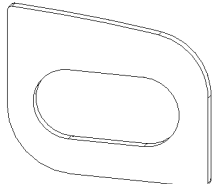
NO.	QTY	PICTURE	NO.	QTY	PICTURE
①	1	 Driver/left Mounting Bracket	②	1	 Passenger/Right Mounting Bracket
③	1	 Support Bracket (L)	④	1	 Support Bracket (R)
⑤	4	 Bracket Spacers	⑥	4	 2-Sided Foam Decals

b. SPART PART LIST

NO.	NAME	QTY	REMARK	NO.	NAME	QTY	REMARK
⑦	Nylon Lock Nut	4	M12	⑧	Hex Bolt (Full Thread)	4	M12_35
⑨	Flat Washer	4	D12_32_3	⑩	Nylon Lock Nut	2	M8
⑪	Hex Bolt (Full Thread)	2	M8_30	⑫	Flat Washer	2	D8(8x24x2mm)

Installation Steps**STEP 1:**

Verify that all parts are present according to the manual.

STEP 2:**Models with plastic bumper cover:**

1. Remove the plastic covers from the front of the bumper, NOTE: Unplug sensors, if equipped, to remove covers.

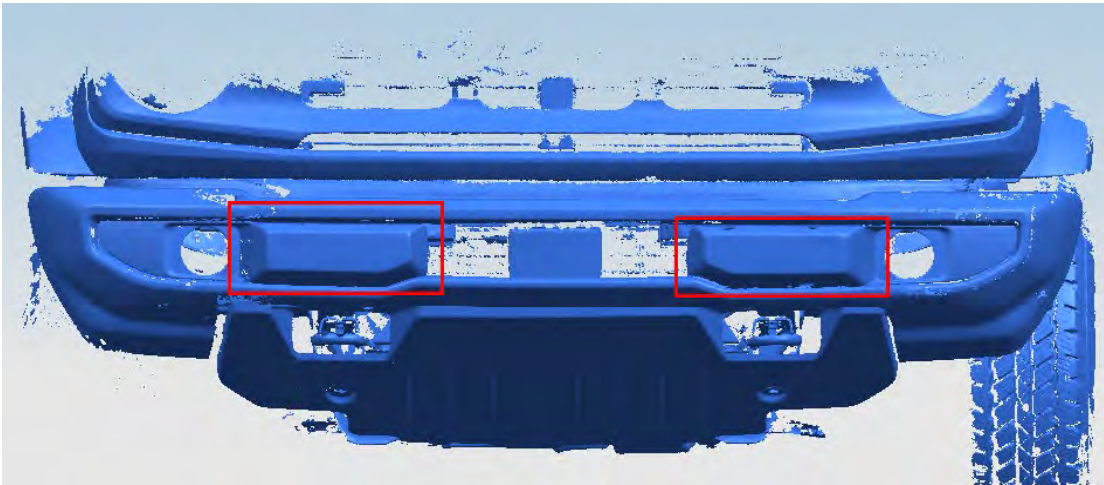

2. Use the factory hex bolts of the plastic cover inner bumper to fix ①② to the bumper.

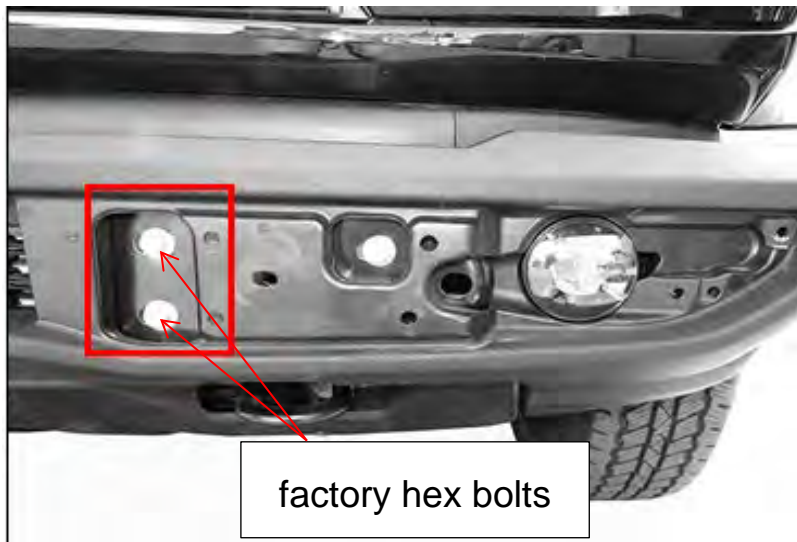
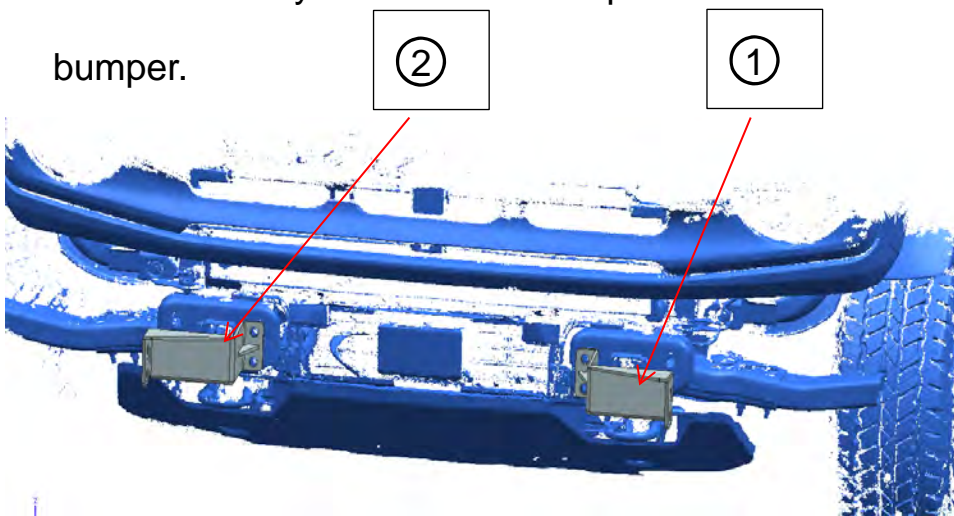

3. Models with plastic bumper cover, measure 4-1/4" from inner end. Draw straight vertical line. Cut the inner end off of the plastic bumper cover, install it back.

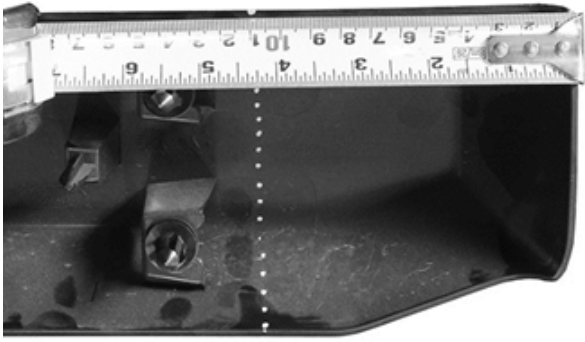

4. Use (7)(8)(9) to install the front bumper on (1)(2).

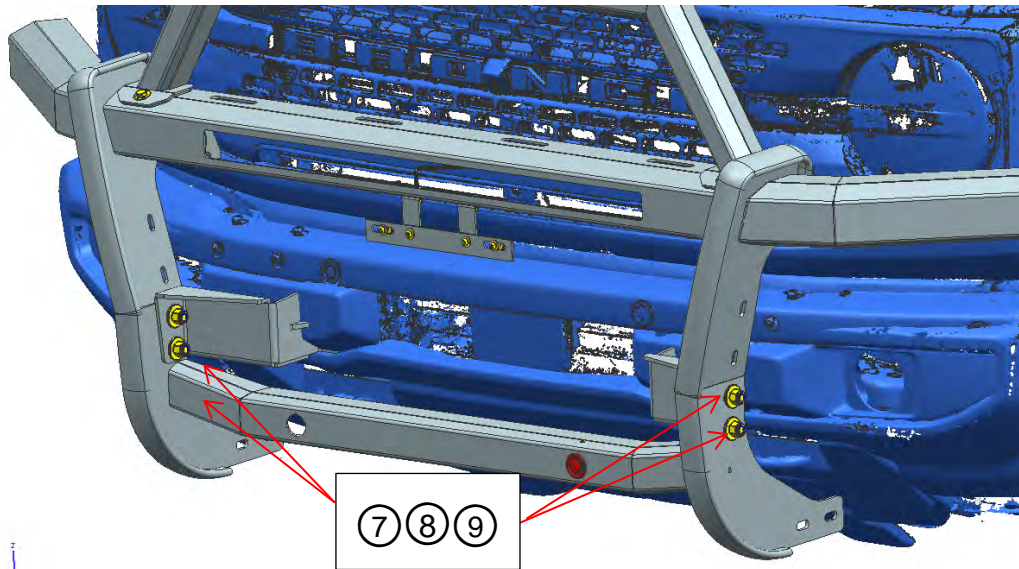

Models with optional steel bumper:

1. It is need to first remove the factory car bumper and use the factory hex bolts matching (10) to install the support bracket (1)(2).

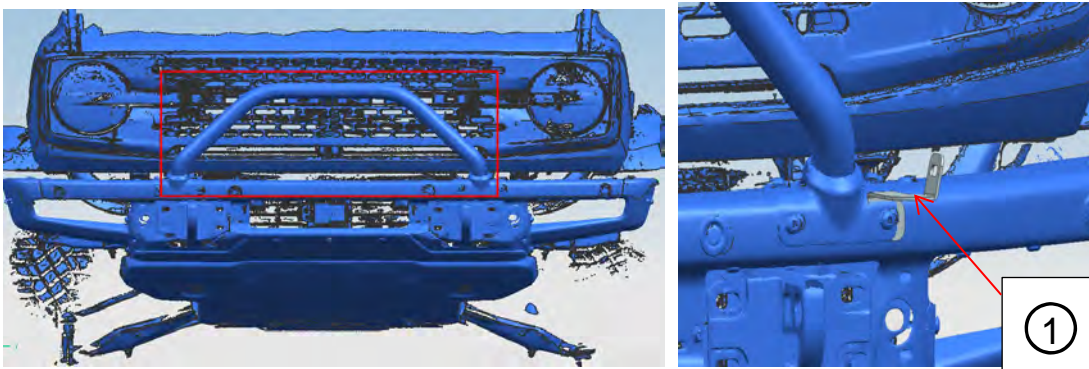

2. Install (3)(4) on the tow hook using the factory tow hook bolts as shown in the figure below, pay attention that between mounting bracket and tow hook need to use spacers (5) and double sided foam decals (6) to level up, symmetrical installation on both sides.

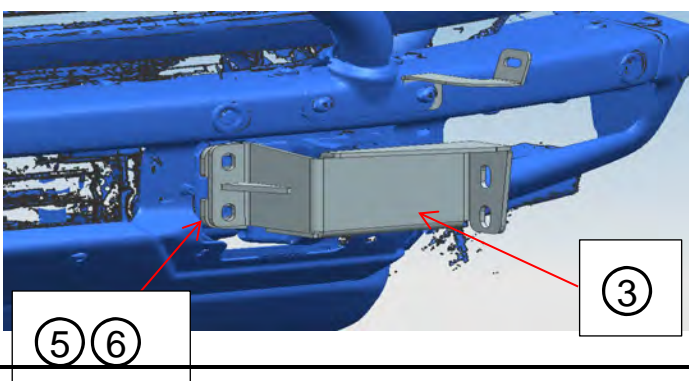

3. Use (7)(8)(9) to install the front bumper on (1)(2), and use (10)(11)(12) to install the front bumper on (3)(4).

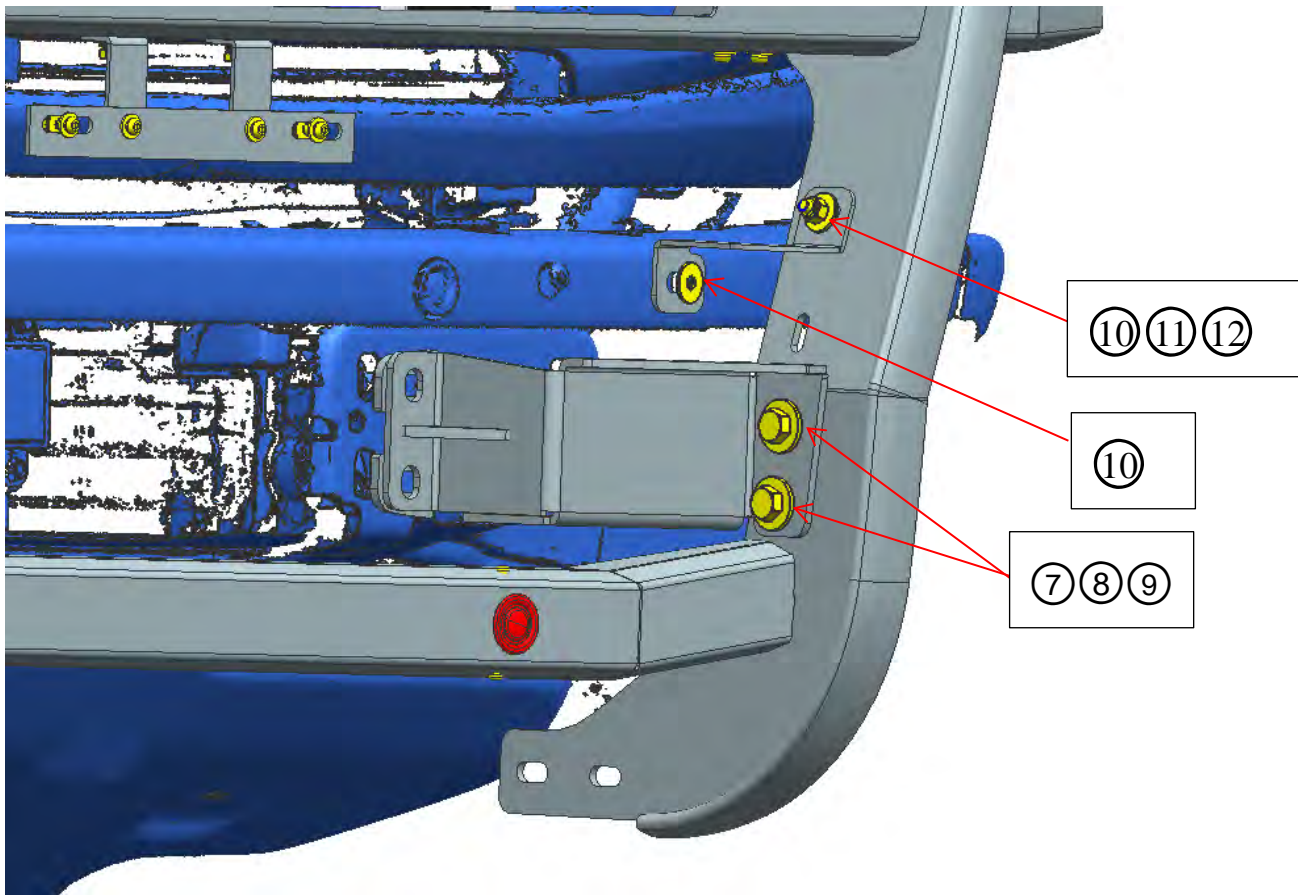

Finished installation as below shown:



NOTE

Any damages and losses caused by improper installation and application, goes beyond our quality warranty.









Before Installation

- Please read the instruction completely for easy installation, which will also help you to avoid scratches or other potential damages to your appealing car.
- The figures here are for reference only and may have differences with the actual product you received, however they share the same assembly way.

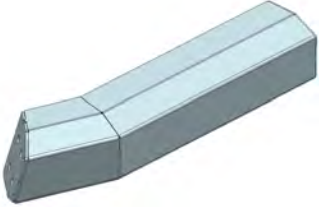
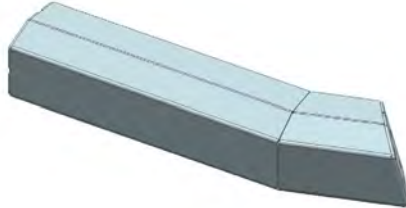



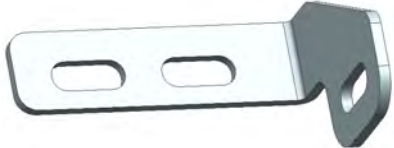

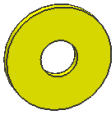





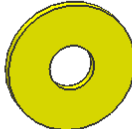

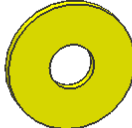
Care and Cleaning

- Mild soap may be used also to clean the Product.
- Please periodically check and retighten all the hardware and clean the investment for a refresh look.

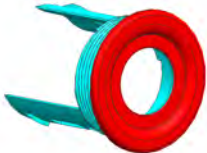
Parts list

NO.	QTY	NAME	NO.	QTY	NAME
①	1	 Main Guard	②	1	 Front Cross bar
③	1	 Left Side Bar	④	1	 Right Side Bar
⑤	2	 License Bracket 1	⑥	1	 License Bracket 2
⑦	1	 Left Spotlight Bracket	⑧	1	 Right Spotlight Bracket
⑨	1	 Allen Wrench S=4	⑩	8	 Flat Washer D10_27_3

UNIVERSAL RAMBLER GRILLE GUARD FOR MID-SIZE TRUCKS

⑪	4	 Nylon Lock Nut M10	⑫	12	 Nylon Lock Nut M8
⑬	12	 Hex Bolt (full thread) M8_30	⑭	24	 Flat Washer D8 (8x24x2mm)
⑮	4	 Hex Bolt (full thread) M10_35	⑯	10	 Flat Washer D6 (6x18x1.6mm)
⑰	10	 Hex Nut M6	⑱	10	 Assembly Button Head Bolt M6_20/A2-70
⑲	2	 Radar Cap	⑳	2	 Plastic Radar Bracket
㉑	2	 Hex Lock Ring M31x1.5	㉒	2	 Adhesive Tape (Half circle with hole D20.6X10)
㉓	6	 Circle Adhesive Tape (D25-d15.5)	㉔	2	 Compression Cover
㉕	4	 Cross Recessed Pan Head Self Tapping Bolt (F-Type Flat Tail) ST4_15			

Installation Steps

Installation Figure:

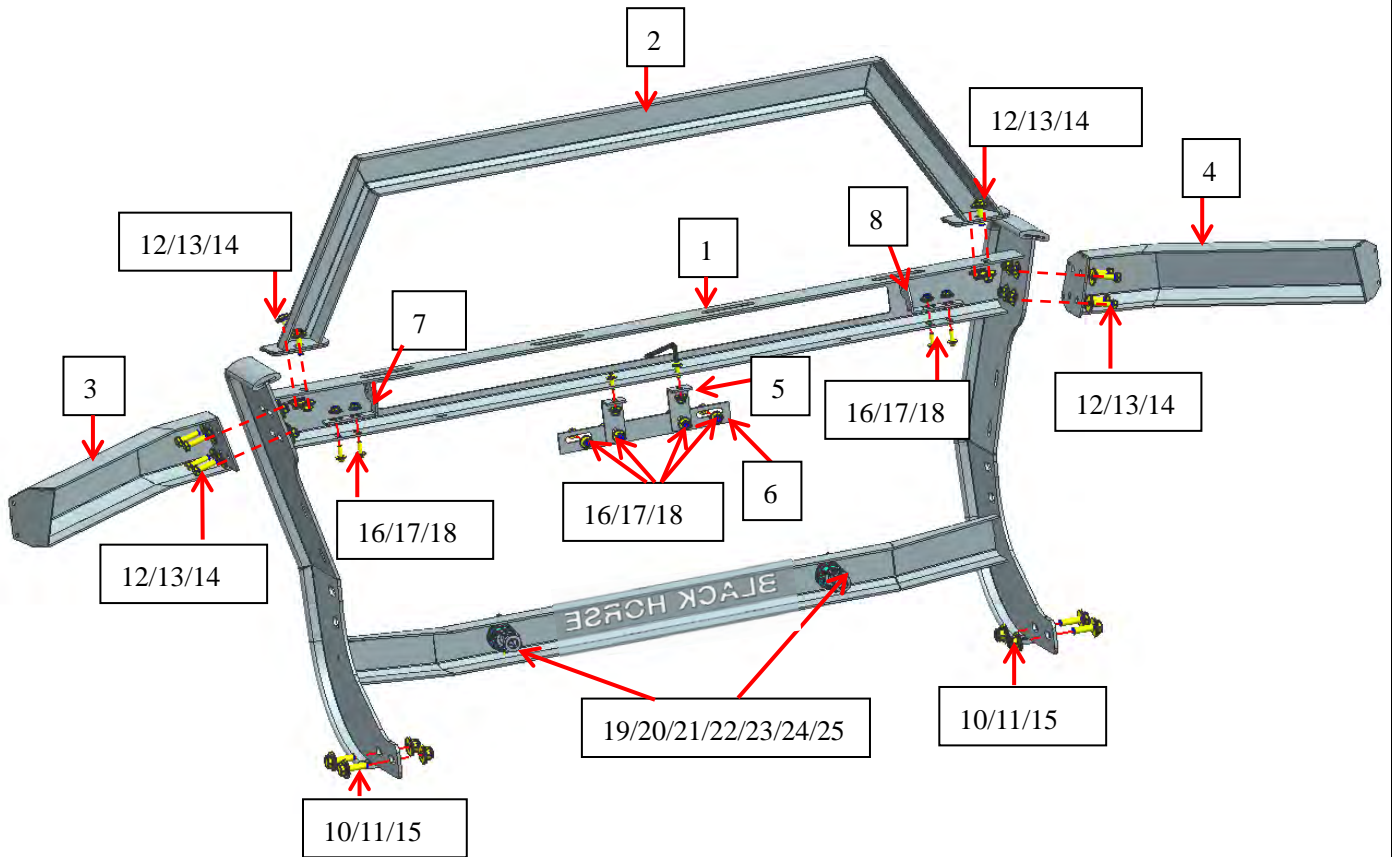

Step 1: Verify all parts are present.

Step 2: Use standard parts to install Front Cross bar with Main Guard as below figure shown.

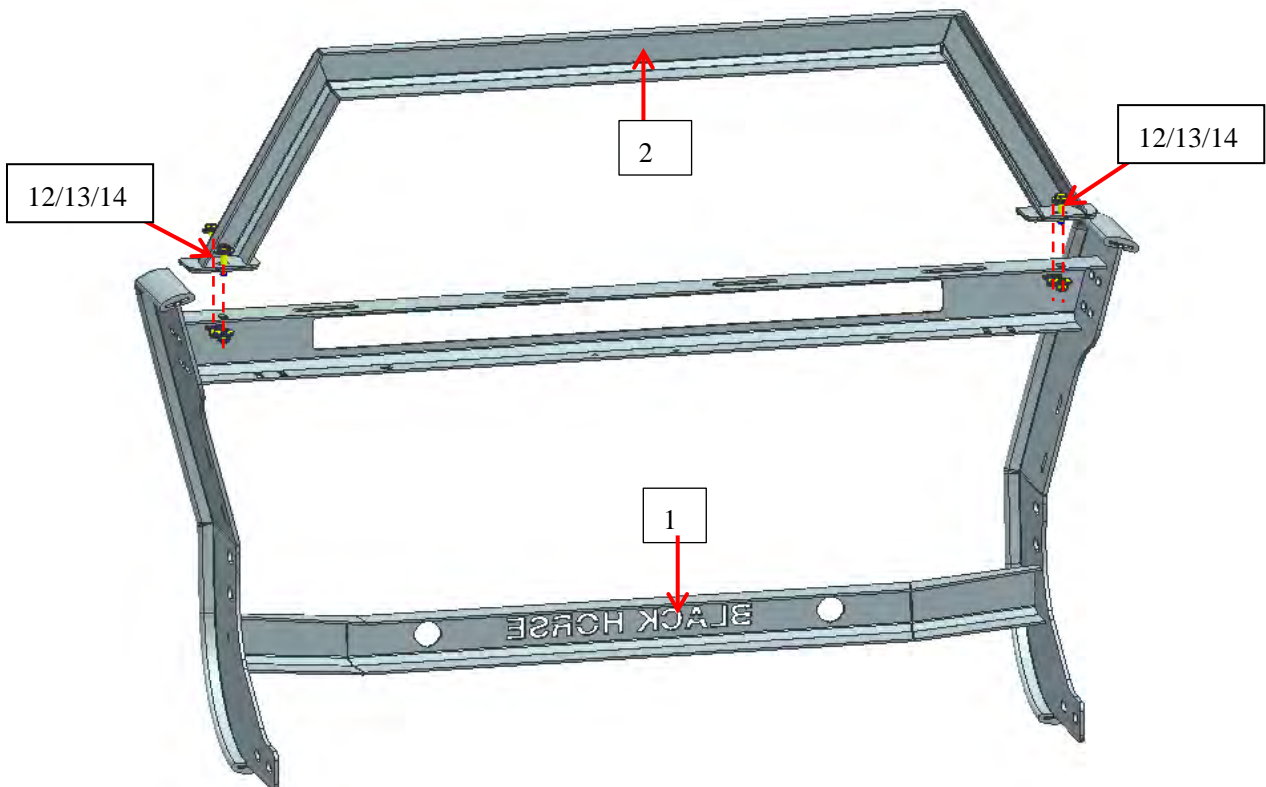

Step 3: Use standard parts to install Left and Right Spotlight Brackets with Main Guard as below figure shown.

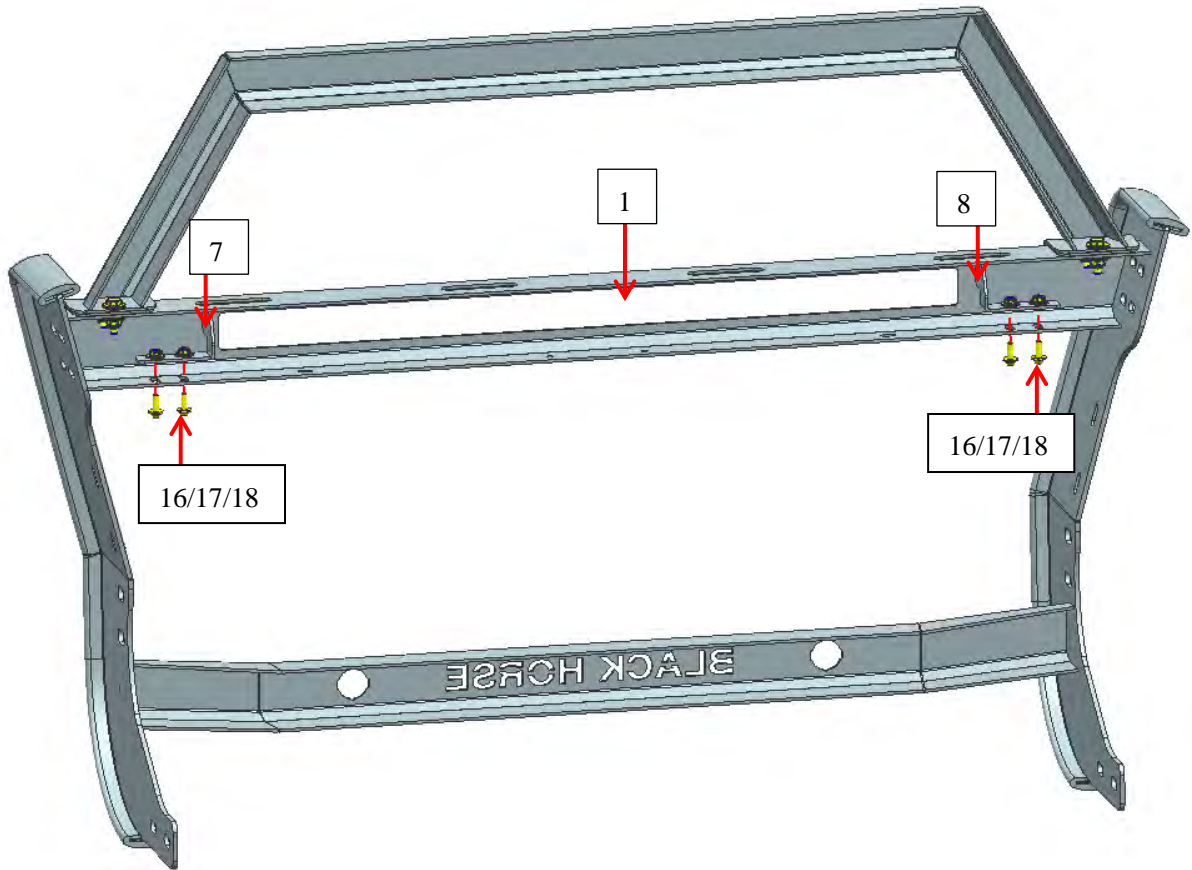

Step 4: Use standard parts to install License Brackets 1 and 2 with Main Guard as below figure shown.

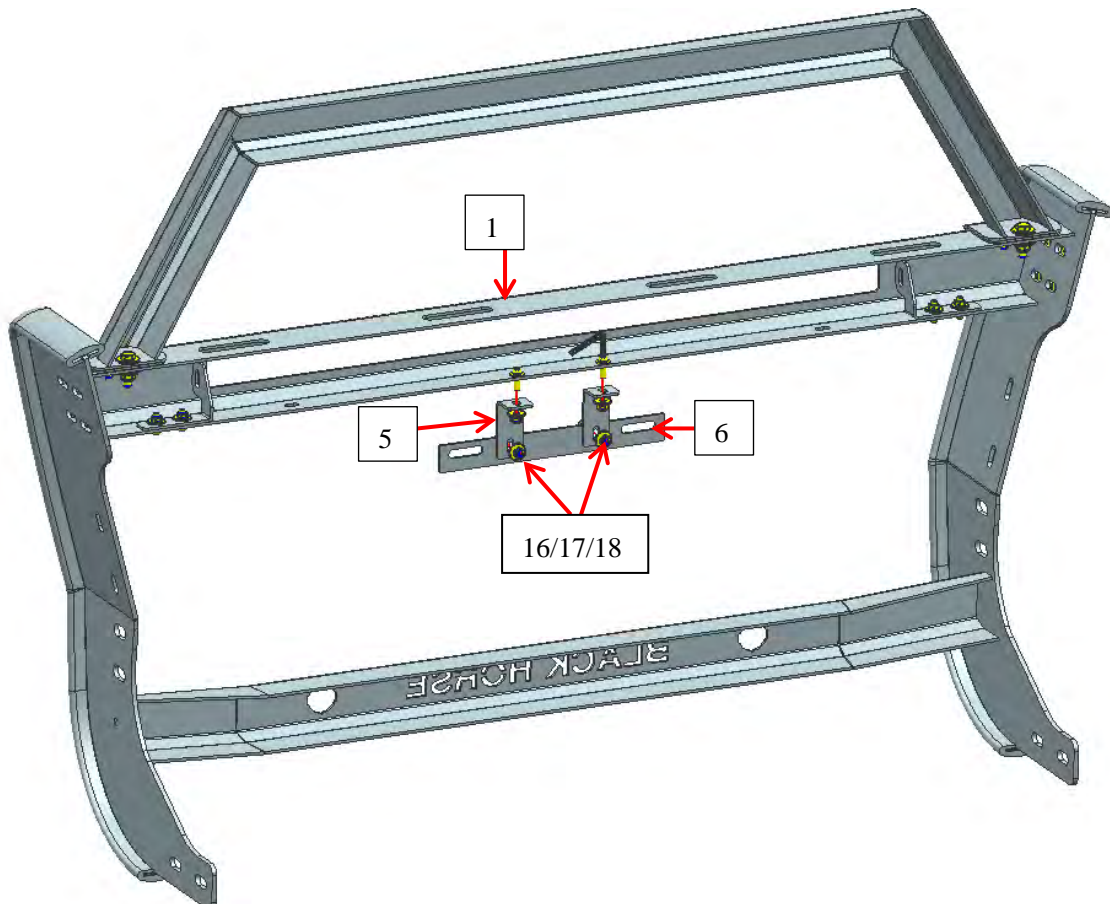

Step 5: Use standard parts to install Left and Right Side Bars with Main Guard as below figure shown.

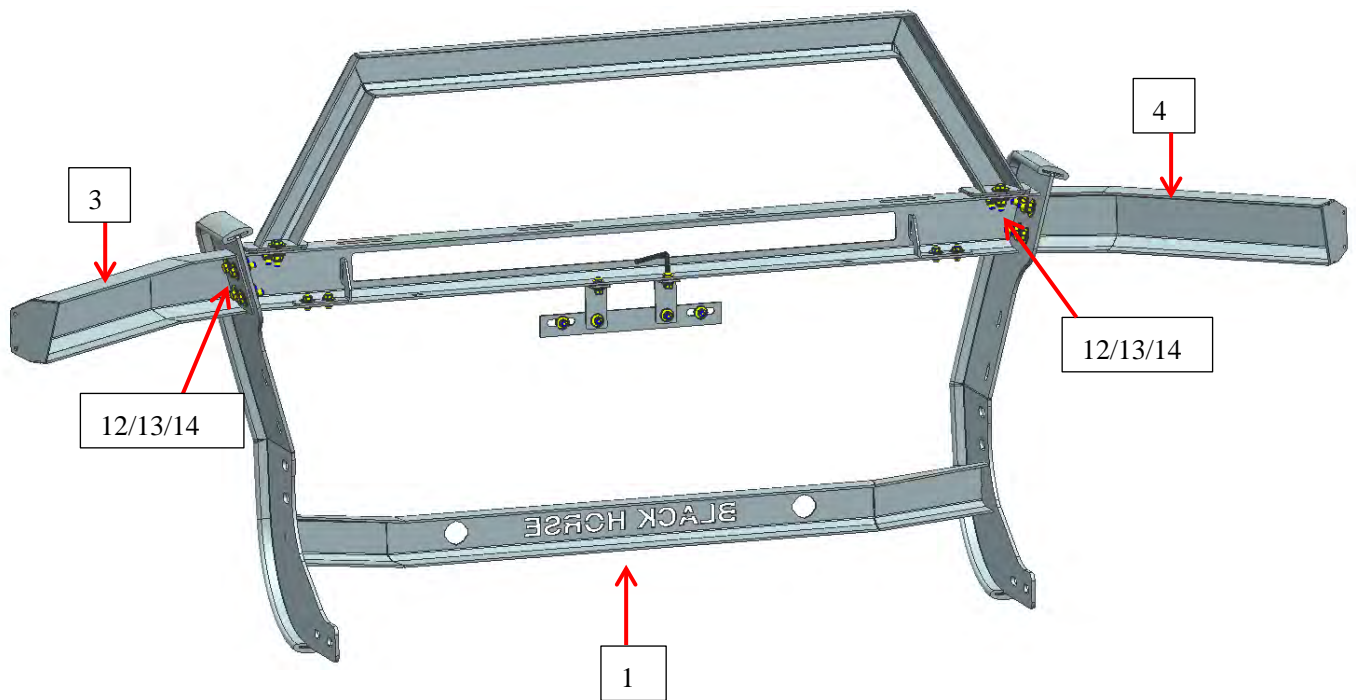

Step 6: Find 2 radar holes on the grille guard and install them according to the standard parts shown in below pictures.

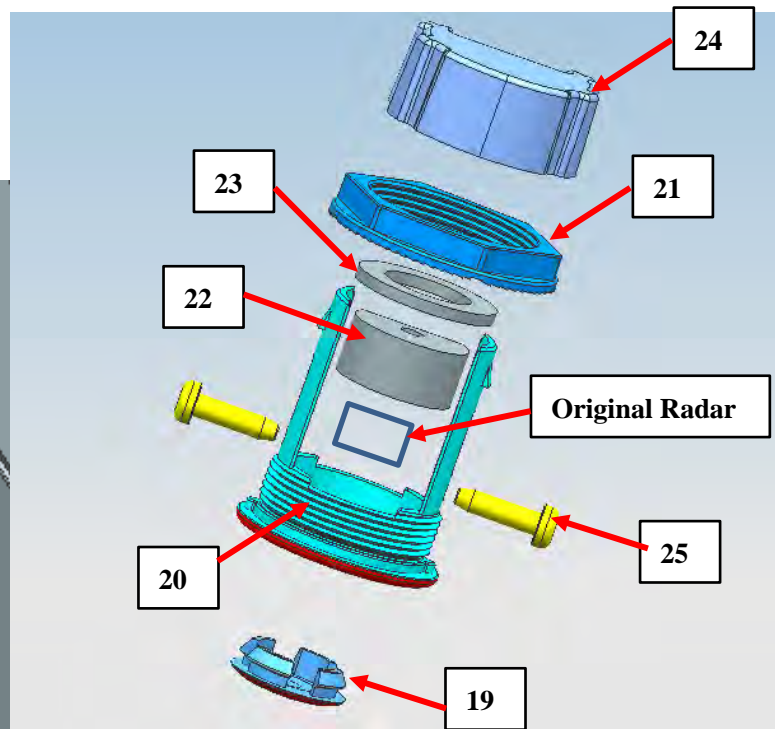
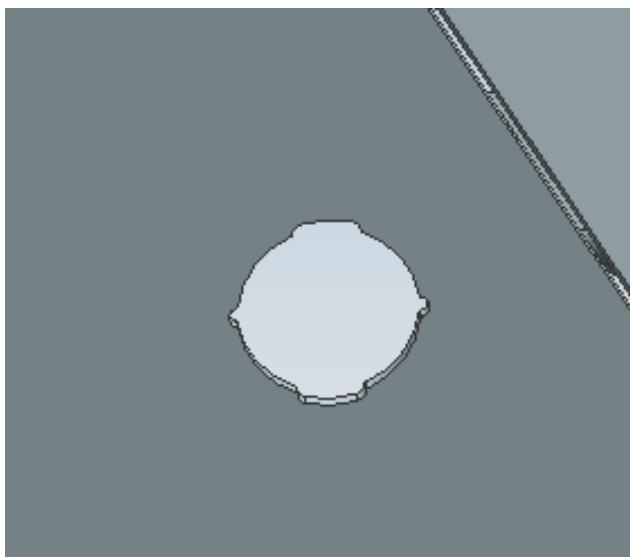

Completed installation:

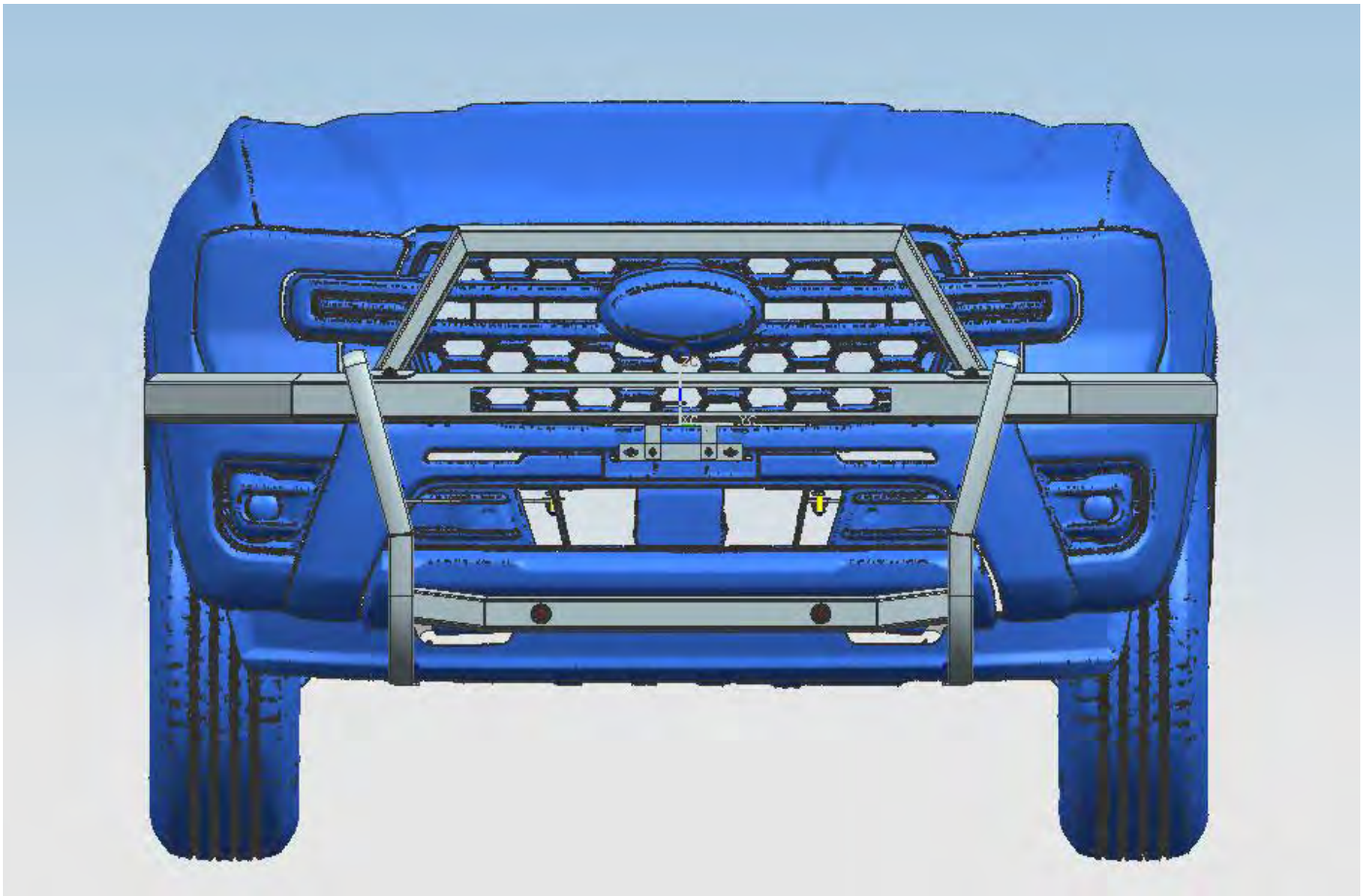
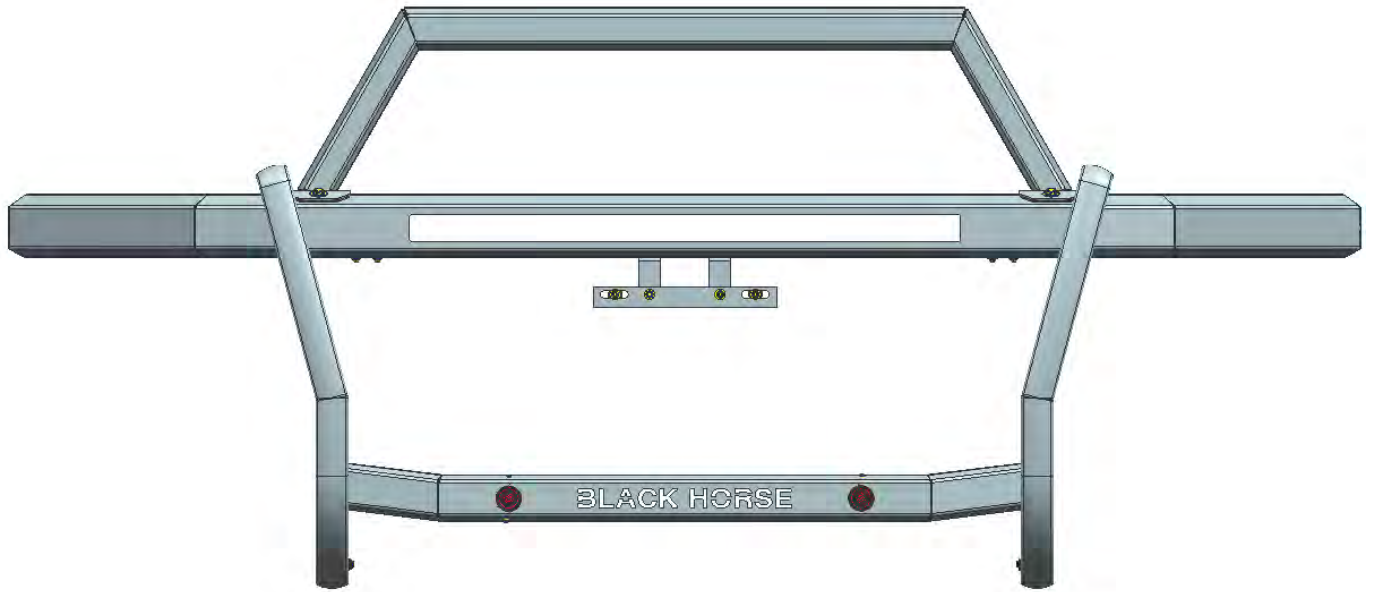

NOTE

Any damages and losses caused by improper installation and application, goes beyond our quality warranty.