



TEL: 1-866-XANATOS

INSTALLATION INSTRUCTIONS

RAMBLER GRILLE GUARD BRACKET

FOR 10-24 TOYOTA 4RUNNER

PART # RAGT20

PROTECTED BY ONE OR MORE PATENT







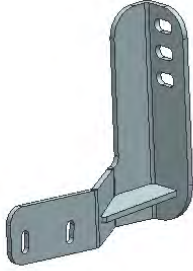
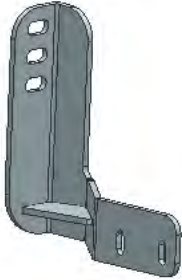

Before Installation

- Please read the instruction completely for easy installation, which will also help you to avoid scratches or other potential damages to your appealing car.
- The figures here are for reference only and may have differences with the actual product you received, however they share the same assembly way.





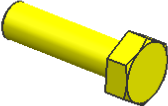

Care and Cleaning

- Mild soap may be used also to clean the Product.
- Please periodically check and retighten all the hardware and clean the investment for a refresh look.

Parts list

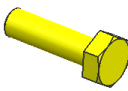
NO.	QTY	NAME	NO.	QTY	NAME
①	1	 Driver/Left Mounting Bracket	②	1	 Driver/Right Mounting Bracket
③	1	 Driver/Left Support Bracket 1	④	1	 Passenger/Right Support Bracket 1
⑤	1	 Driver/Left Support Bracket 2	⑥	1	 Passenger/Right Support Bracket 2
⑦	1	 Driver/Left Support Bracket 3	⑧	1	 Passenger/Right Support Bracket 3
⑨	2	 Short Sleeve Piece	⑩	2	 Hex Bolt (Full Thread) M8_30

RAMBLER GRILLE GUARD BRACKET FOR 10-24 TOYOTA 4RUNNER

⑪	2		⑫	8	
		Nylon Lock Nut M8			Flat Washer D8(8x24x2mm)
⑬	2		⑭	4	
		Hex Bolt (Full Thread) M8_40			Flat Washer D6(6x18x1.6mm)
⑮	4		⑯	1	
		Hex Nut M6			Allen Wrench S=4
⑰	4				
		Hex Bolt Assembly M6_20/A2-70			

Installation Steps

Installation Figure:

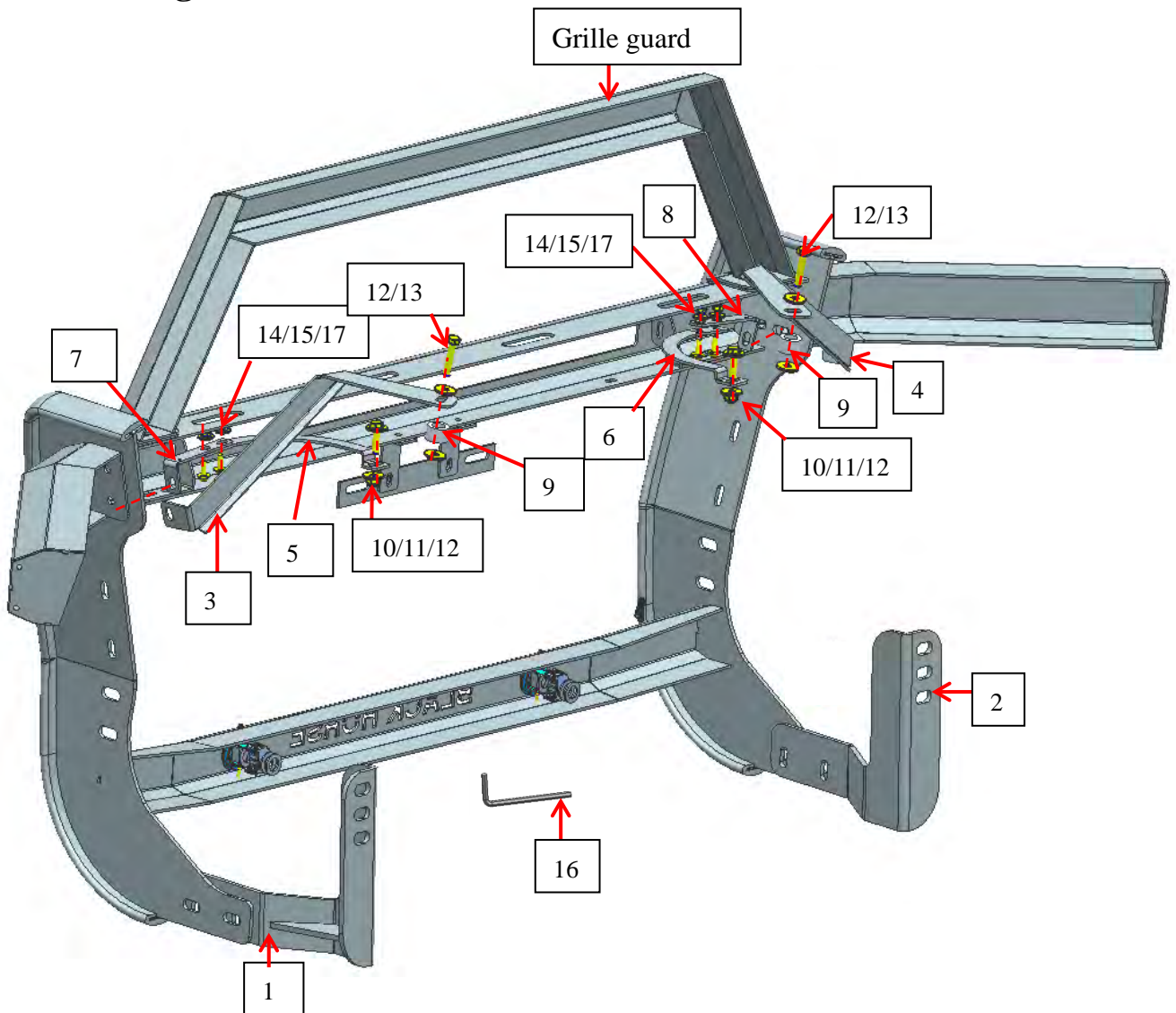

RAMBLER GRILLE GUARD BRACKET FOR 10-24 TOYOTA 4RUNNER

Step 1: Check all the contents are available in accordance with the above list.

Step 2: Find the installation hole for left support bracket 1 on the front bumper of the vehicle body, fix it with standard parts and short sleeves piece. The left and right are consistent; the following figure shows the left side. (Used for adaptation to models from 2014-2023).

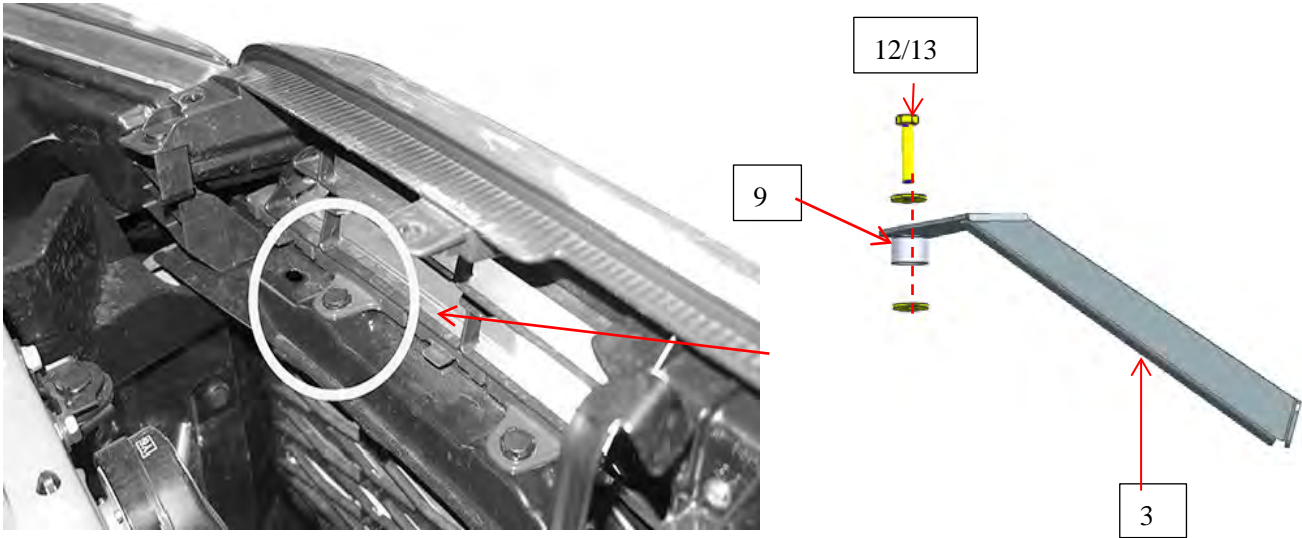

Step 3: Find the installation hole for left support bracket 2 on the front bumper of the vehicle body, fix it with standard parts. The left and right are consistent; the following figure shows the left side. (Used for adaptation to models from 2010-2013).

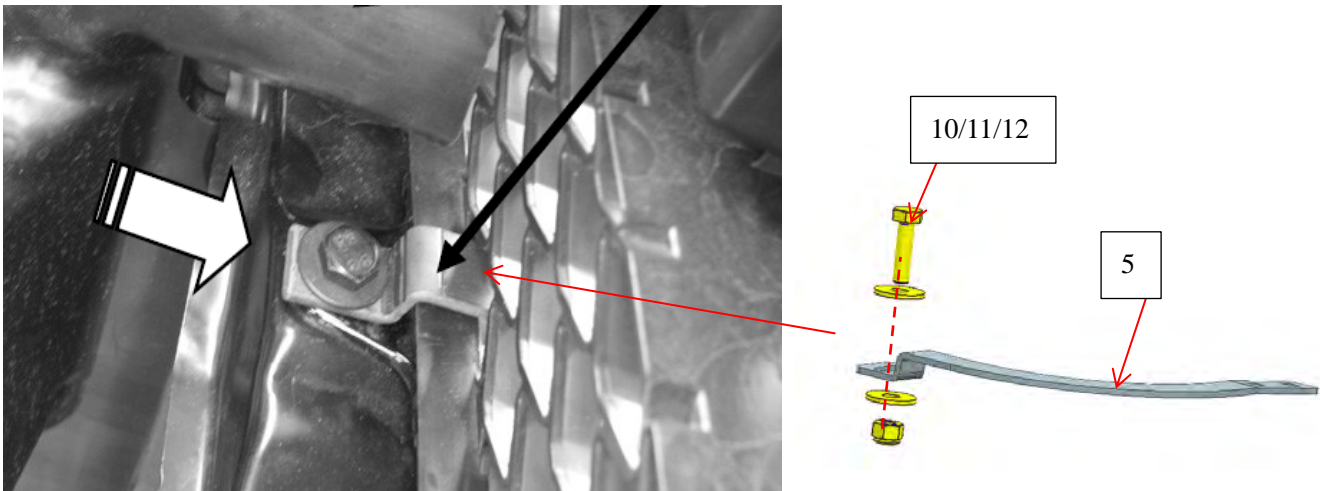

Step 4: Installation left support bracket 2 in conjunction with left support bracket 3, fix it with standard parts. The left and right are consistent; the following figure shows the left side.(Used for adaptation to models from 2010 - 2013).

RAMBLER GRILLE GUARD BRACKET FOR 10-24 TOYOTA 4RUNNER

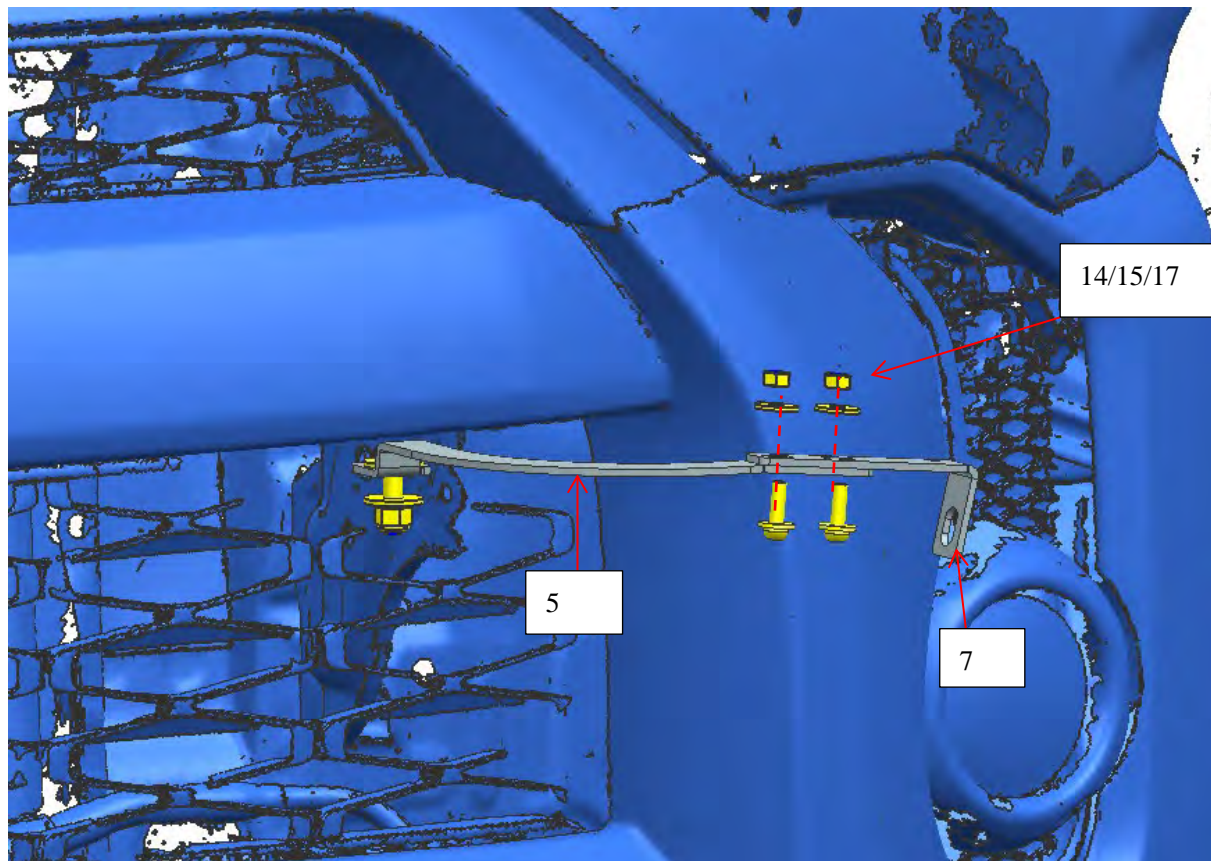

Step 5: Find the installation hole for the left mounting bracket on the body beam and fix it to the beam using standard parts. The left and right are consistent. The following figure shows the left side.

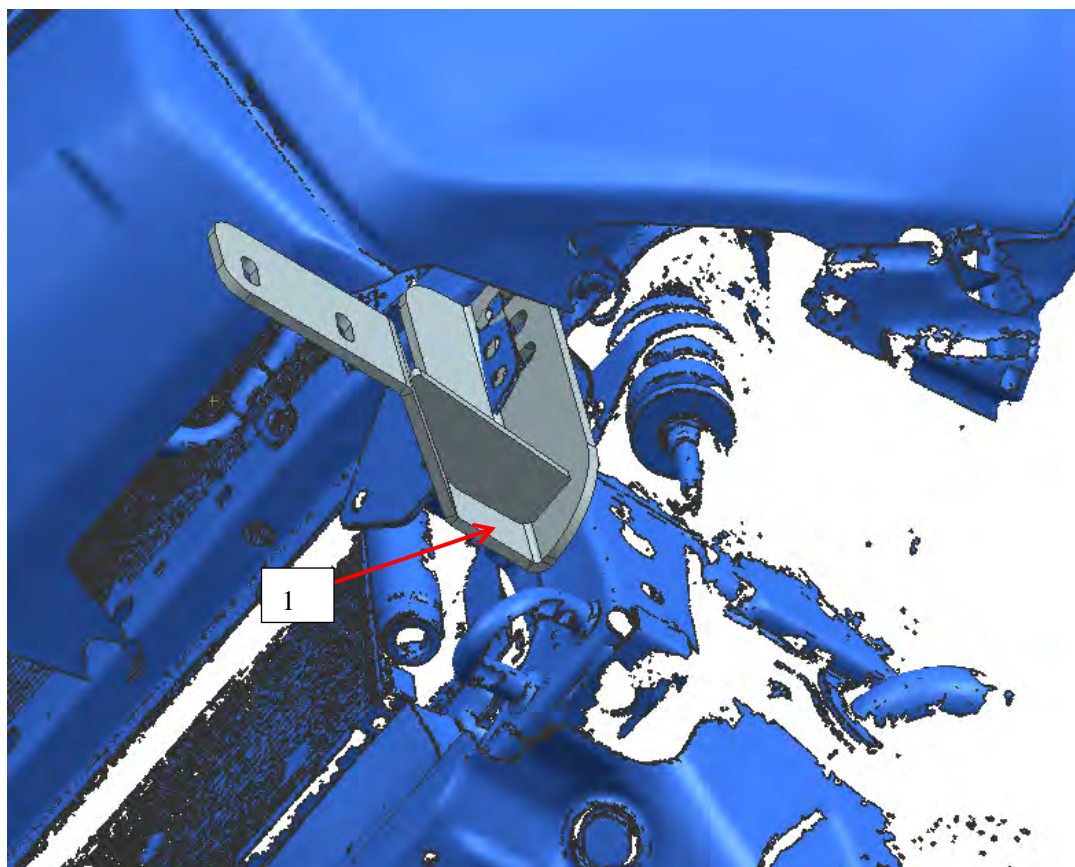

Step 6: Fix the left mounting bracket, left support bracket 1, left support bracket 3, and Grille guard using standard parts, the left and right are consistent. The following figure shows the left side. Note that the

RAMBLER GRILLE GUARD BRACKET FOR 10-24 TOYOTA 4RUNNER

standard parts with red frames need to be connected to the support bracket before installation

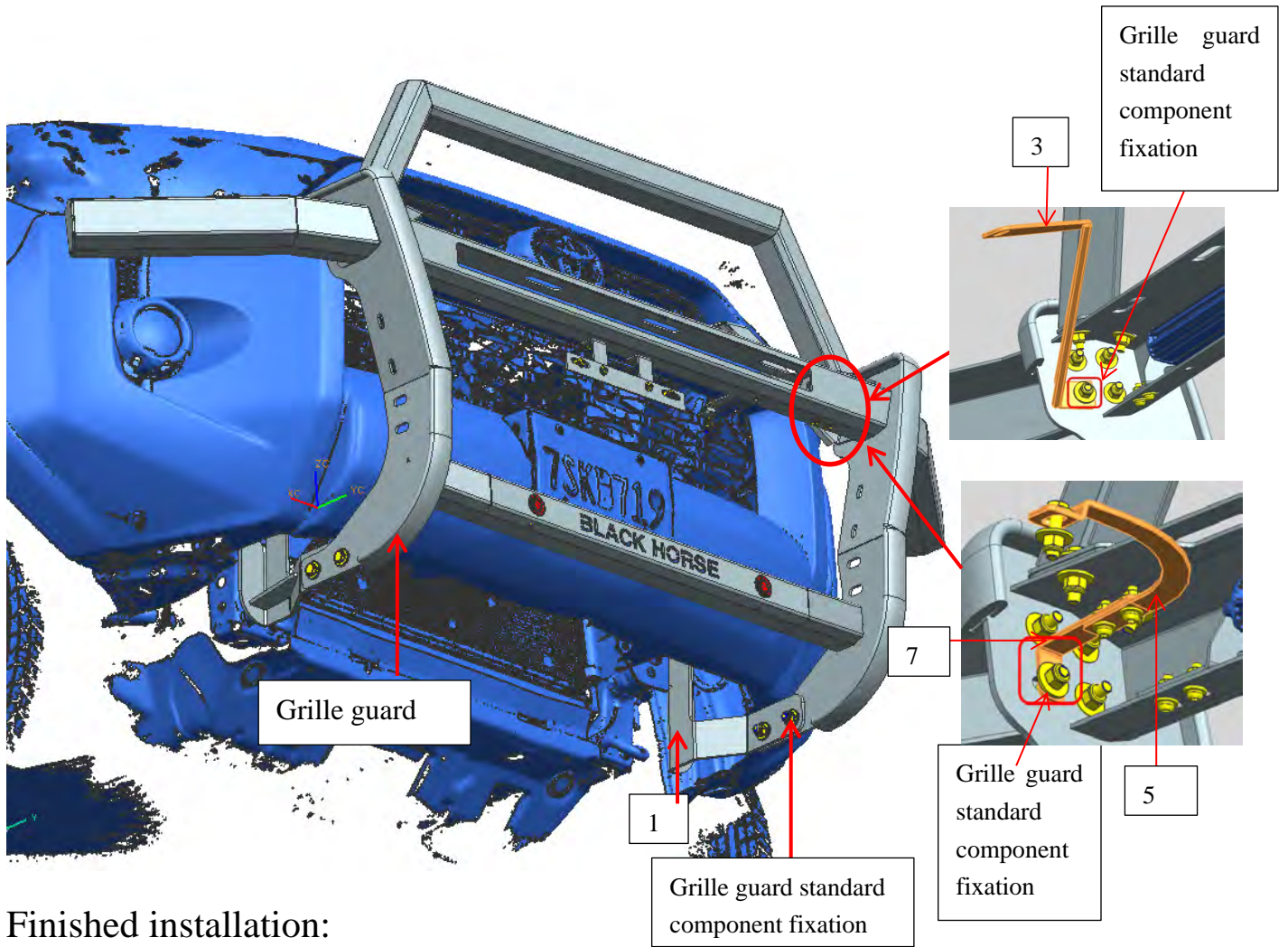

Finished installation:

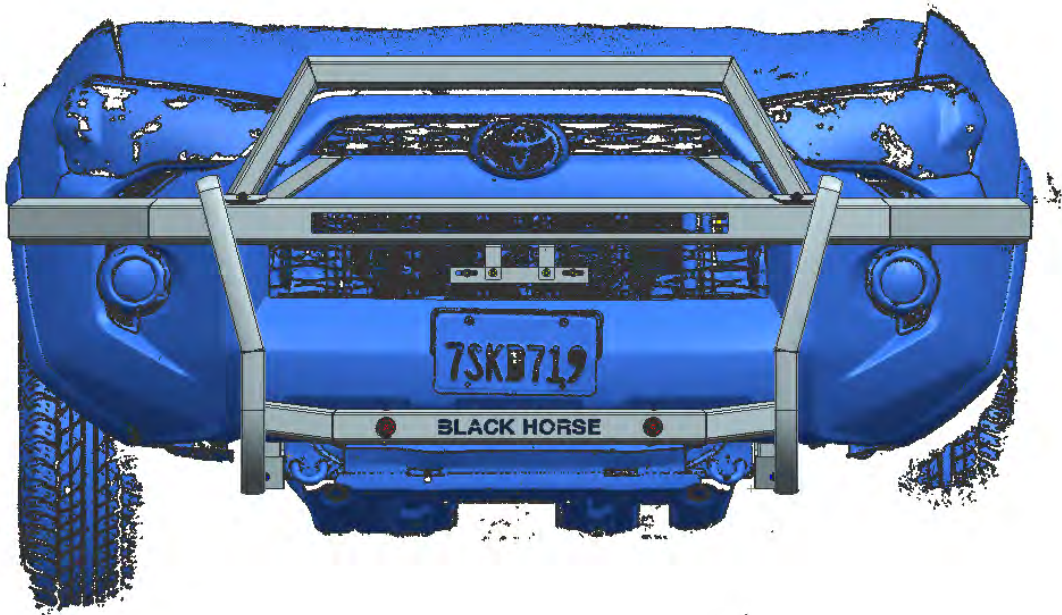

NOTE

Any damages and losses caused by improper installation and application, goes beyond our quality warranty.









Before Installation

- Please read the instruction completely for easy installation, which will also help you to avoid scratches or other potential damages to your appealing car.
- The figures here are for reference only and may have differences with the actual product you received, however they share the same assembly way.

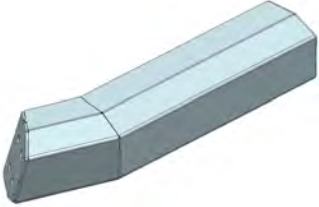
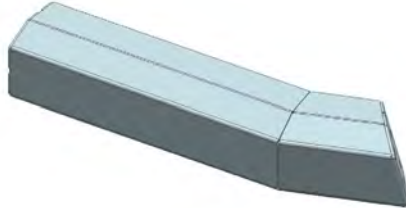



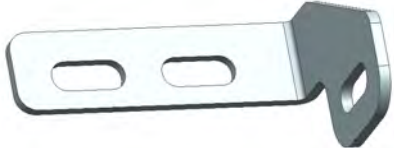

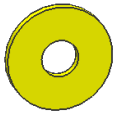



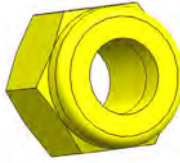

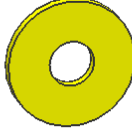

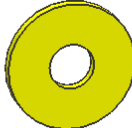
Care and Cleaning

- Mild soap may be used also to clean the Product.
- Please periodically check and retighten all the hardware and clean the investment for a refresh look.

Parts list

NO.	QTY	NAME	NO.	QTY	NAME
①	1	 Main Guard	②	1	 Front Cross bar
③	1	 Left Side Bar	④	1	 Right Side Bar
⑤	2	 License Bracket 1	⑥	1	 License Bracket 2
⑦	1	 Left Spotlight Bracket	⑧	1	 Right Spotlight Bracket
⑨	1	 Allen Wrench S=4	⑩	8	 Flat Washer D10_27_3

UNIVERSAL RAMBLER GRILLE GUARD FOR MID-SIZE TRUCKS

⑪	4	 Nylon Lock Nut M10	⑫	12	 Nylon Lock Nut M8
⑬	12	 Hex Bolt (full thread) M8_30	⑭	24	 Flat Washer D8 (8x24x2mm)
⑮	4	 Hex Bolt (full thread) M10_35	⑯	10	 Flat Washer D6 (6x18x1.6mm)
⑰	10	 Hex Nut M6	⑱	10	 Assembly Button Head Bolt M6_20/A2-70
⑲	2	 Radar Cap	⑳	2	 Plastic Radar Bracket
㉑	2	 Hex Lock Ring M31x1.5	㉒	2	 Adhesive Tape (Half circle with hole D20.6X10)
㉓	6	 Circle Adhesive Tape (D25-d15.5)	㉔	2	 Compression Cover
㉕	4	 Cross Recessed Pan Head Self Tapping Bolt (F-Type Flat Tail) ST4_15			

Installation Steps

Installation Figure:

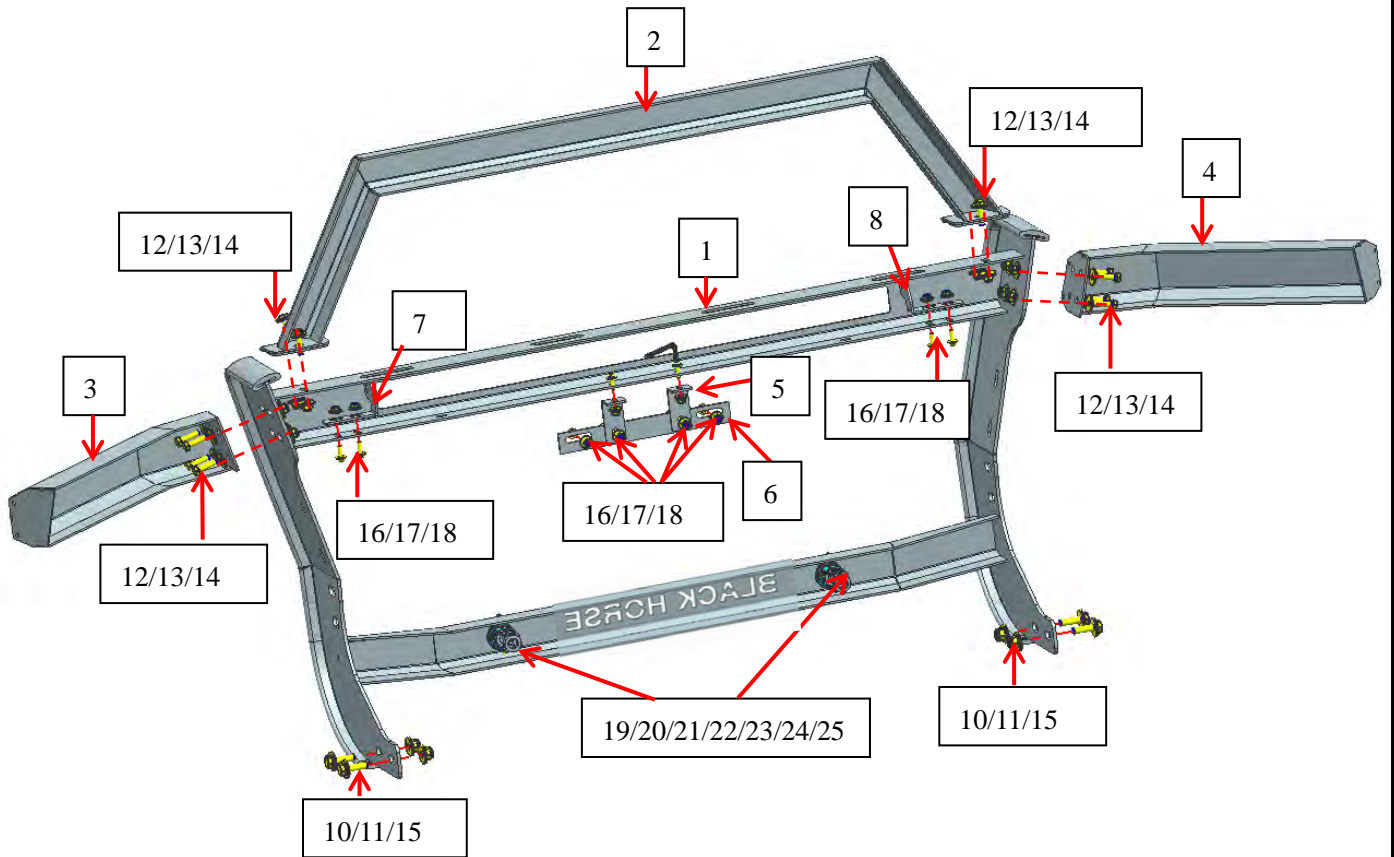

Step 1: Verify all parts are present.

Step 2: Use standard parts to install Front Cross bar with Main Guard as below figure shown.

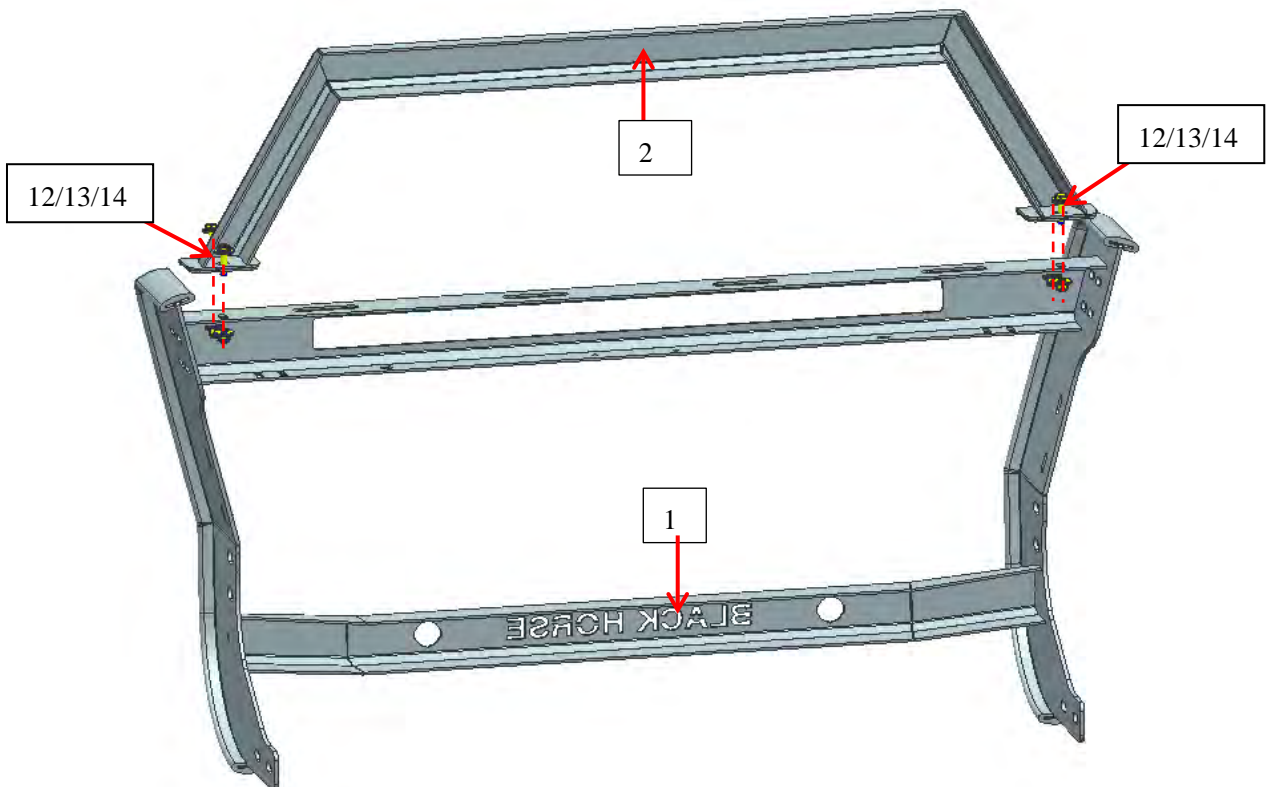

Step 3: Use standard parts to install Left and Right Spotlight Brackets with Main Guard as below figure shown.

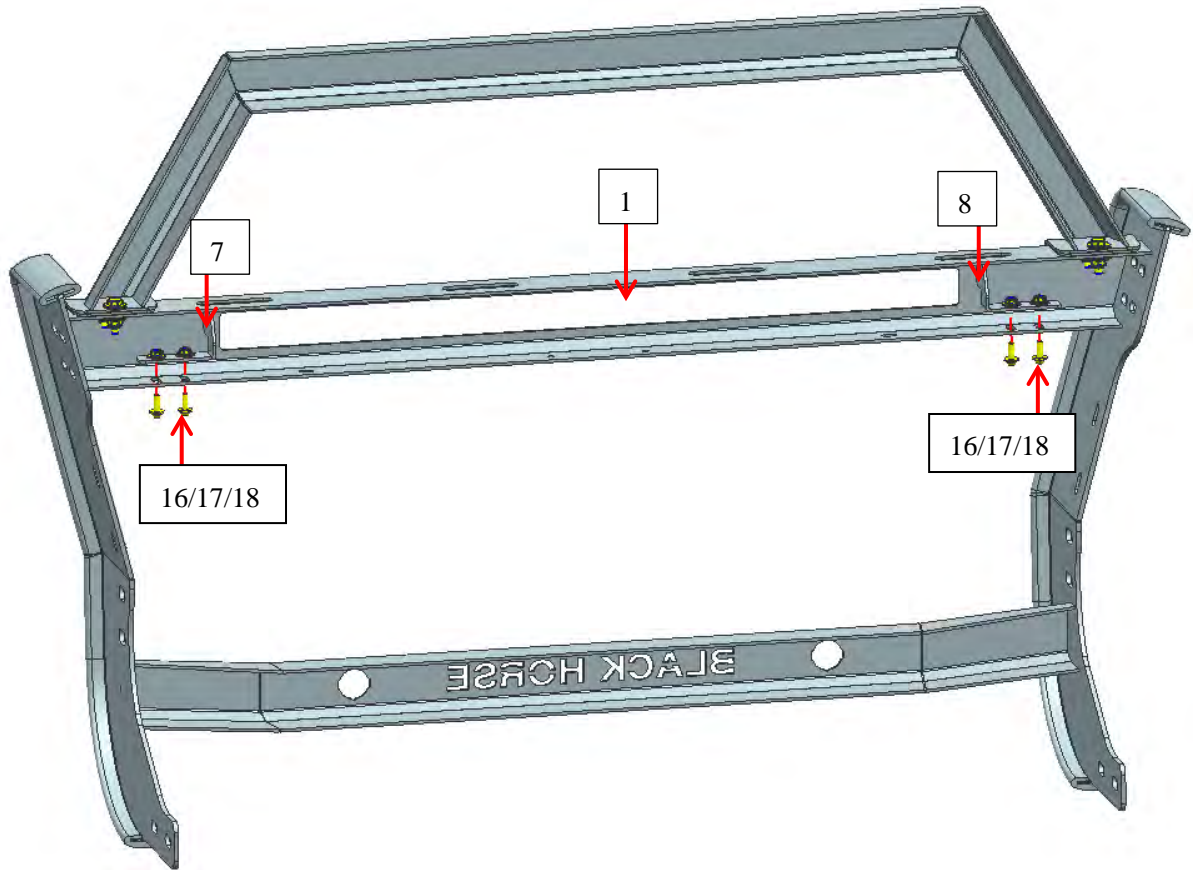

Step 4: Use standard parts to install License Brackets 1 and 2 with Main Guard as below figure shown.

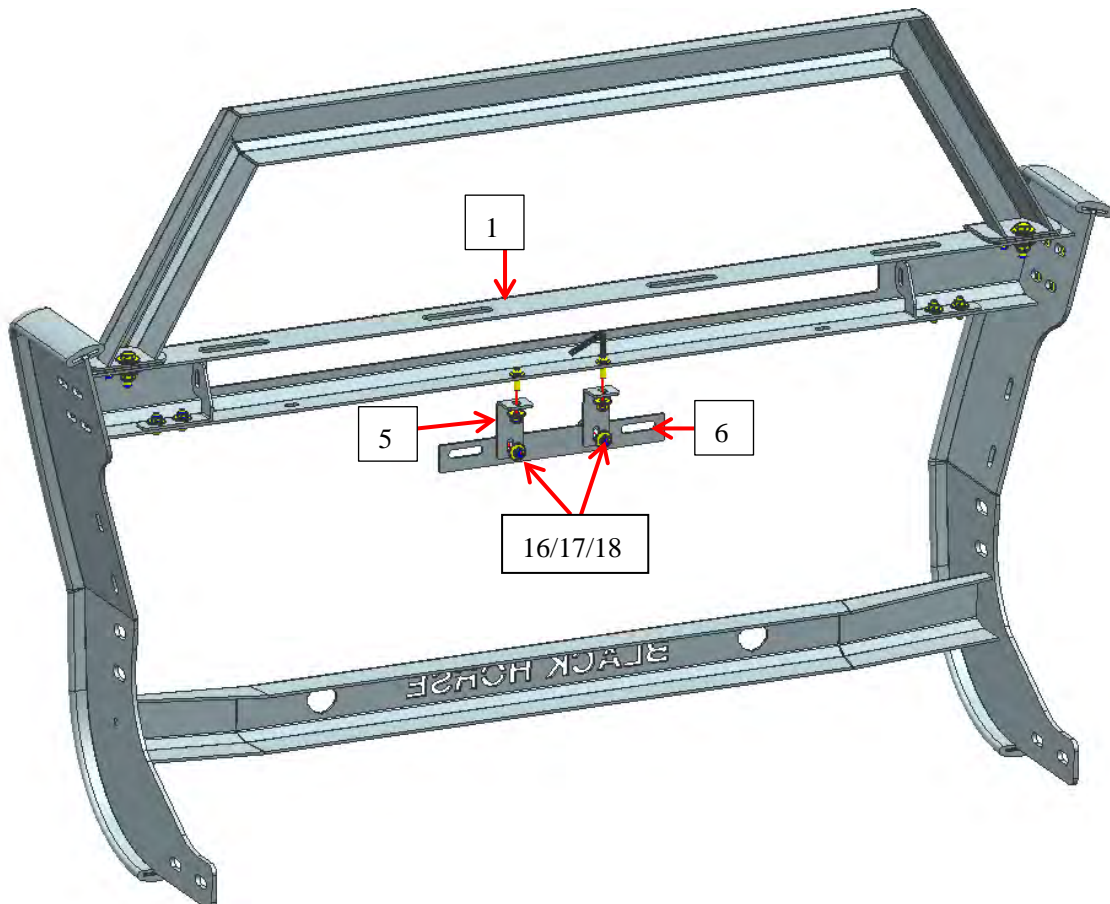

Step 5: Use standard parts to install Left and Right Side Bars with Main Guard as below figure shown.

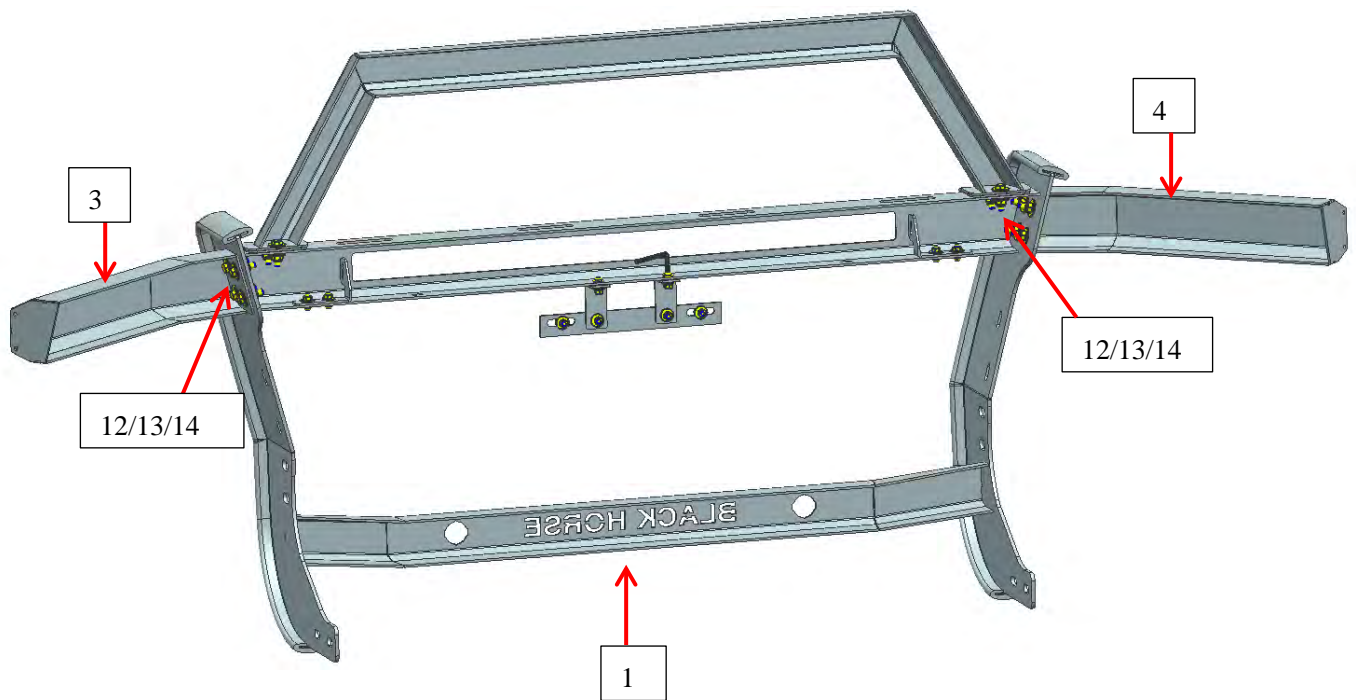

Step 6: Find 2 radar holes on the grille guard and install them according to the standard parts shown in below pictures.

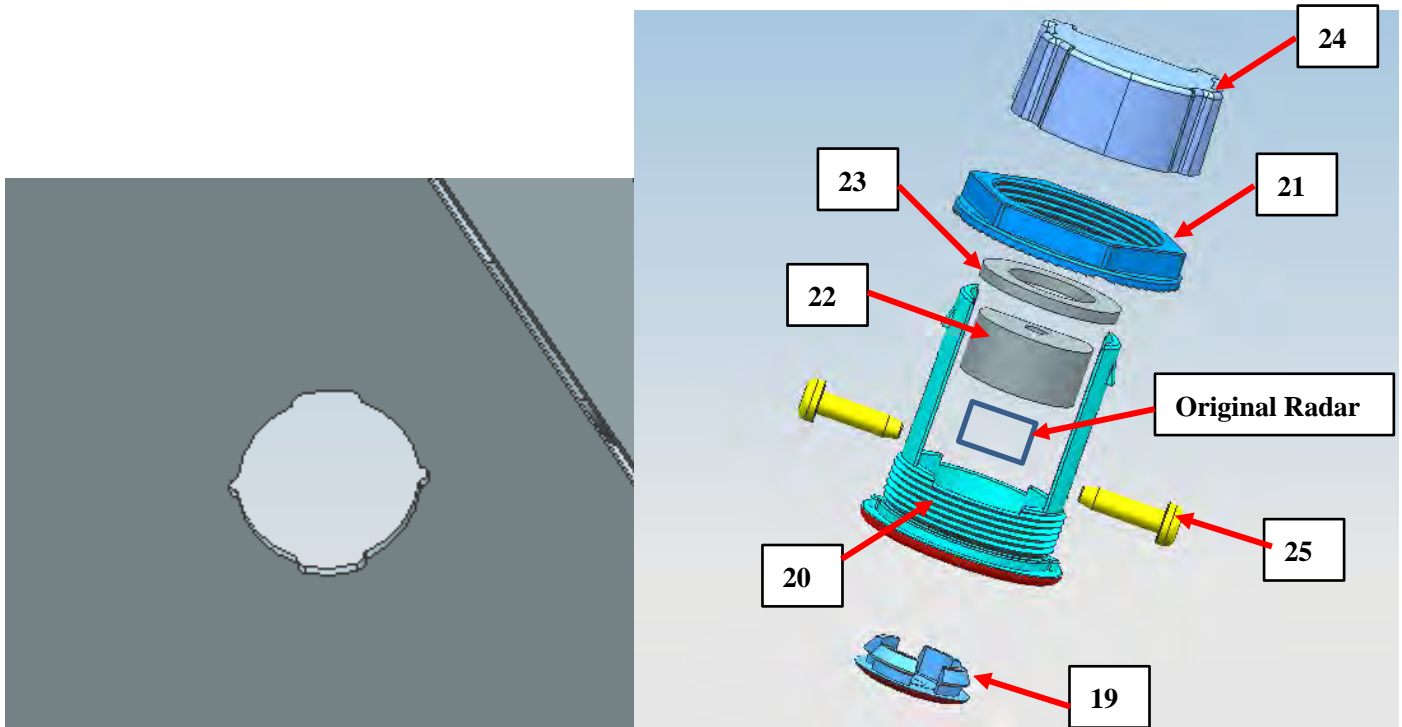

Completed installation:

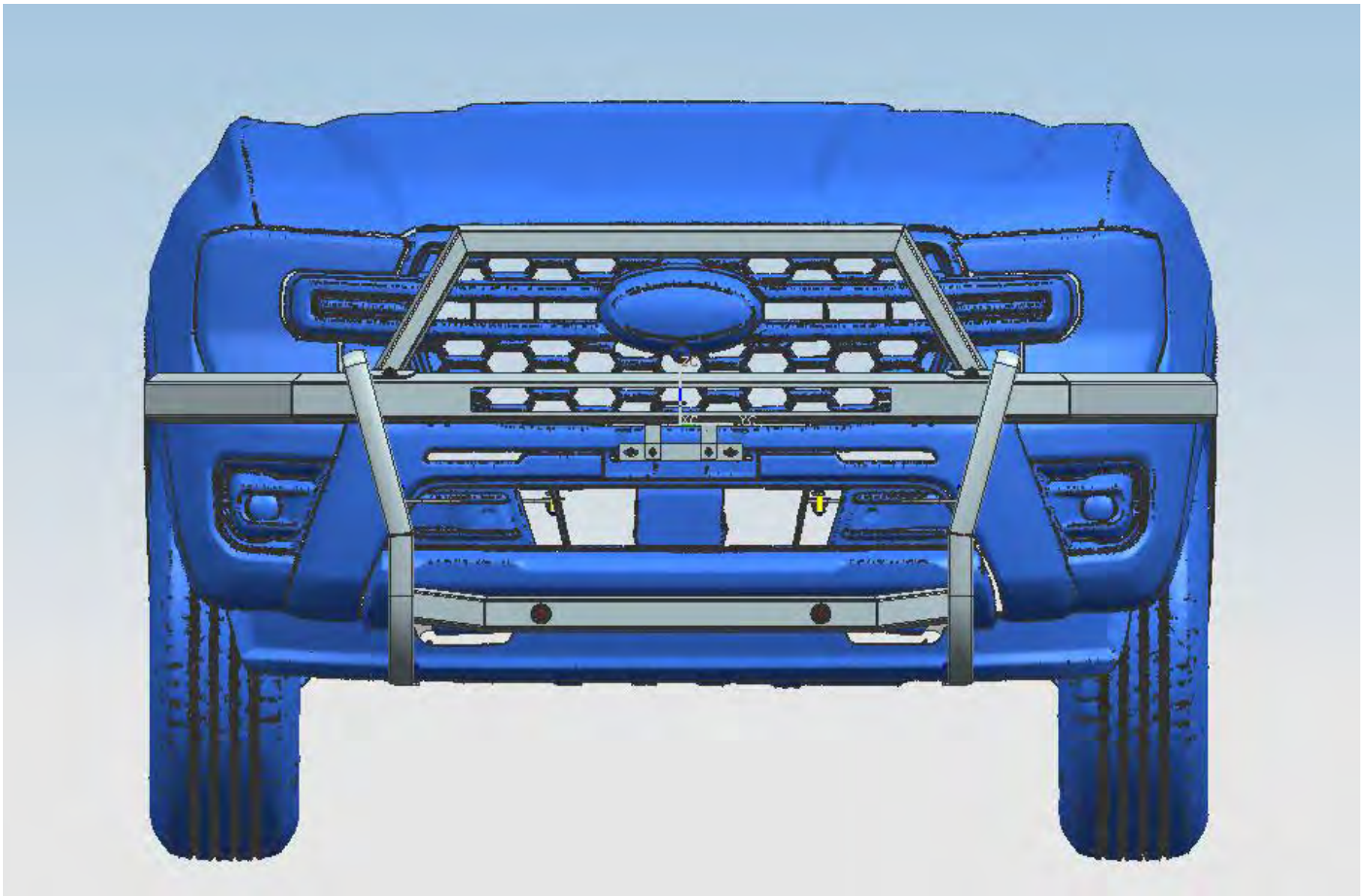
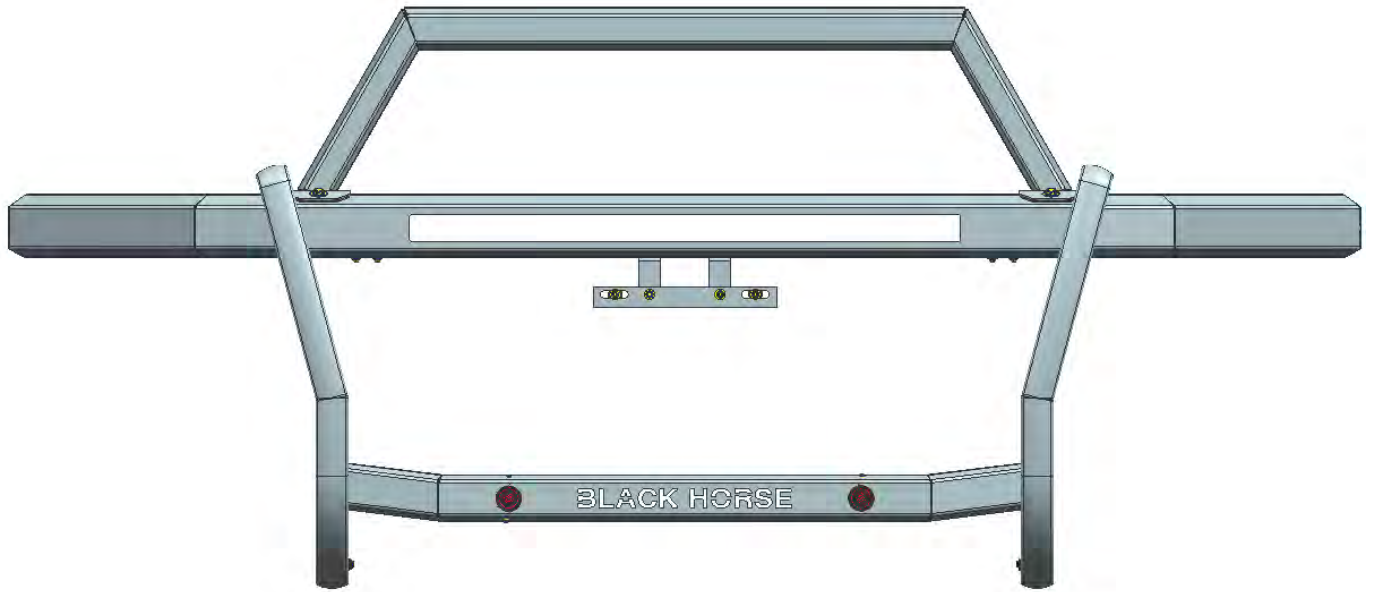

NOTE

Any damages and losses caused by improper installation and application, goes beyond our quality warranty.