



# **INSTALLATION INSTRUCTIONS**

**ROLL BAR TONNEAU COVER BASE FOR DODGE RAM 2015-2018**

**PART #RBB-DO**



## Before Installation



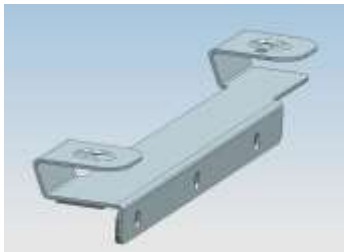
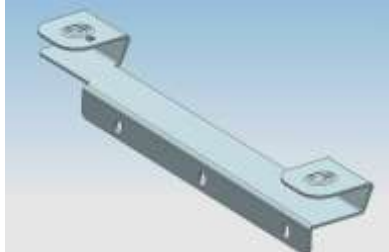

- Please read the instruction completely for easy installation, which will also help you to avoid scratches or other potential damages to your appealing car.
- The information shown here is for reference only and may differ from the product that you receive, however the goods are fitted in the same way.

## Care and Cleaning

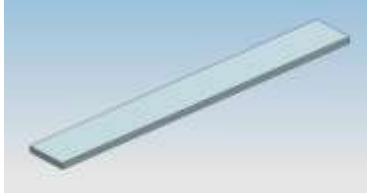
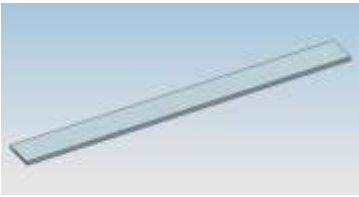
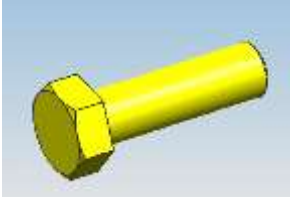
- Mild soap may be used also to clean the Product.
- Please periodically check and retighten all the hardware and clean the investment for a refresh look.

## Parts list

| NO. | QTY | PICTURE  | NO. | QTY | PICTURE   |
|-----|-----|--|-----|-----|---|
| ①   | 1   | <br>Bracket-L         | ②   | 1   | <br>Bracket-R        |
| ③   | 1   | <br>Seal 3 (5mm*1800) | ④   | 2   | <br>Seal 4 (5mm*250) |
| ⑤   | 2   | <br>Seal 5 (3mm*250)  | ⑥   | 6   | <br>Hex bolt M12*40  |

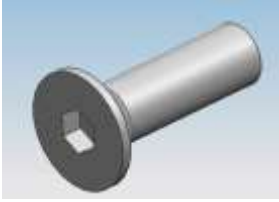
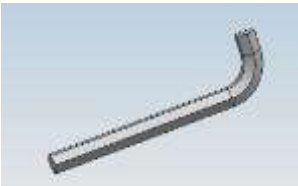
|                   |   |                   |   |
|-------------------|---|-------------------|---|
| <p>⑦</p> <p>6</p> |  <p>Large washer D12</p>             | <p>⑧</p> <p>6</p> |  <p>Flat washer D12</p>  |
| <p>⑨</p> <p>6</p> |  <p>Spring washer D12</p>            | <p>⑩</p> <p>6</p> |  <p>Hex nut M12</p>      |
| <p>⑪</p> <p>4</p> |  <p>Flat head allen bolts M12*40</p> | <p>⑫</p> <p>1</p> |  <p>Allen wrench S=8</p> |

## Installation Steps

FIG.1

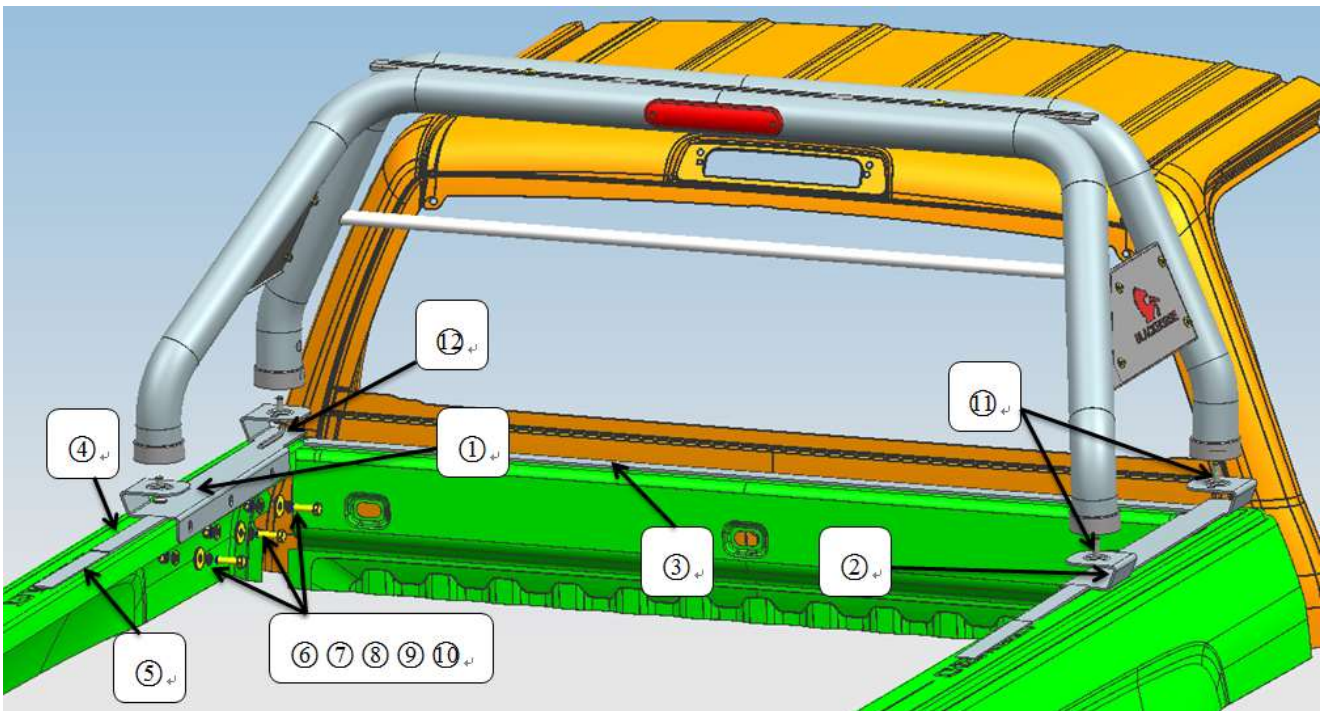

Installed as below show:

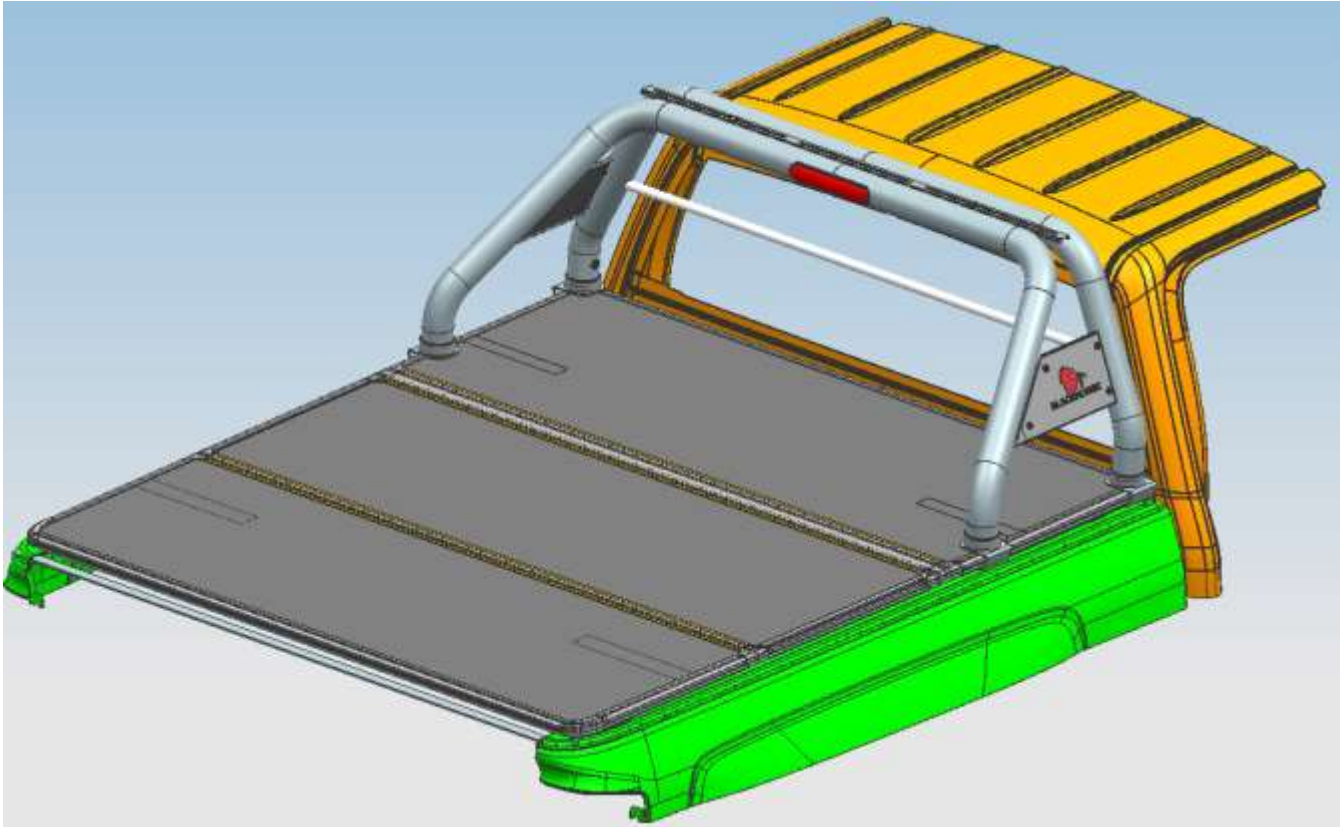

Step 1: Check all the contents are available in accordance with the above list.

Step 2: Prepared the SA roll bar, bracket ① and bracket ②, then use Allen wrench S=8 ⑫ and Flat head allen bolts M12\*40 ⑪ to connect roll bar and brackets without locking them.

Step 3: Use accessories ⑥ ⑦ ⑧ ⑨ ⑩ to fasten roll bar and brackets on the truck at appropriate positions. Then fasten with Flat head allen bolts M12\*40 ⑪.

Step 4: Stick seal ③ ④ ⑤ as FIG.1 shows for avoiding gaps between truck and hard tri-fold cover.

Step 5: Installation is finished.

## NOTE

Any damages and losses caused by improper installation and application, goes beyond our quality warranty.