



**INSTALLATION INSTRUCTIONS**  
**REAR BUMPER GUARD (DOUBLE LAYER) FOR NISSAN**  
**PATHFINDER 13-20**  
**PART # CRDL-NIN201S**

# INSTALLATION INSTRUCTIONS



## Before Installation

- Please read the instruction completely for easy installation, which will also help you to avoid scratches or other potential damages to your appealing car.
- The information shown here is for reference only and may differ from the product that you receive, however the goods are fitted in the same way.





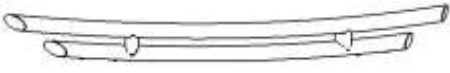
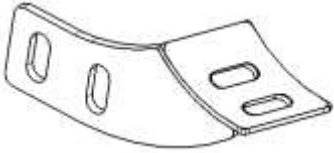
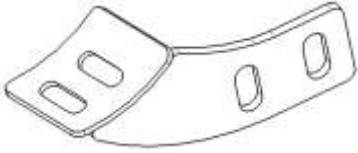

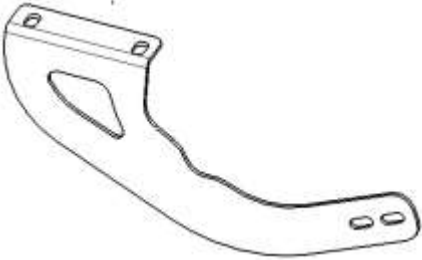
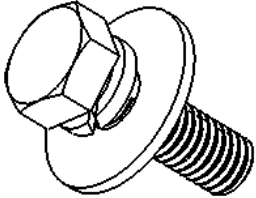
## Care and Cleaning

- Mild soap may be used also to clean the Product.
- Please periodically check and retighten all the hardware and clean the investment for a refresh look.

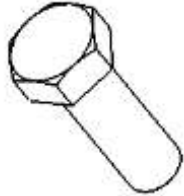
## Parts list

NO.	QTY	PICTURE	NO.	QTY	PICTURE
①	1	 Rear bumper guard	②	1	 Bracket-A(L)
③	1	 Bracket-A(R)	④	1	 Bracket-B(L)
⑤	1	 Bracket-B(R)	⑥	4	 Assembling bolt M8*25

## INSTALLATION INSTRUCTIONS

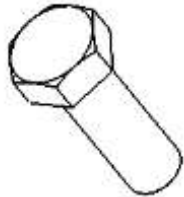
⑦	4	 Hex Bolt M10*35	⑧	8	 Flat washer D10
⑨	4	 Spring washer D10	⑩	4	 Nut D10
⑪	4	 Flat washer D12	⑫	4	 Spring washer D12
⑬	4	 Hex Bolt M12*35			

### Installation Steps

STEP 1: Check all the contents are available in accordance with the above list.

STEP 2: Using M12\*35 bolt to install Bracket-B-L/R as FIG.2 ,Do not tighten all the bolts.

STEP 3: As the FIG.1,first Connect Bracket-A&B ,then install the rear bar on Bracket-A-L&B.

Do not tighten all the bolts.

STEP 4: Test and make sure that the rear bar is steadily fixed, and then tighten all the hardware.

STEP 5: Installation is finished.

# INSTALLATION INSTRUCTIONS

PIC1

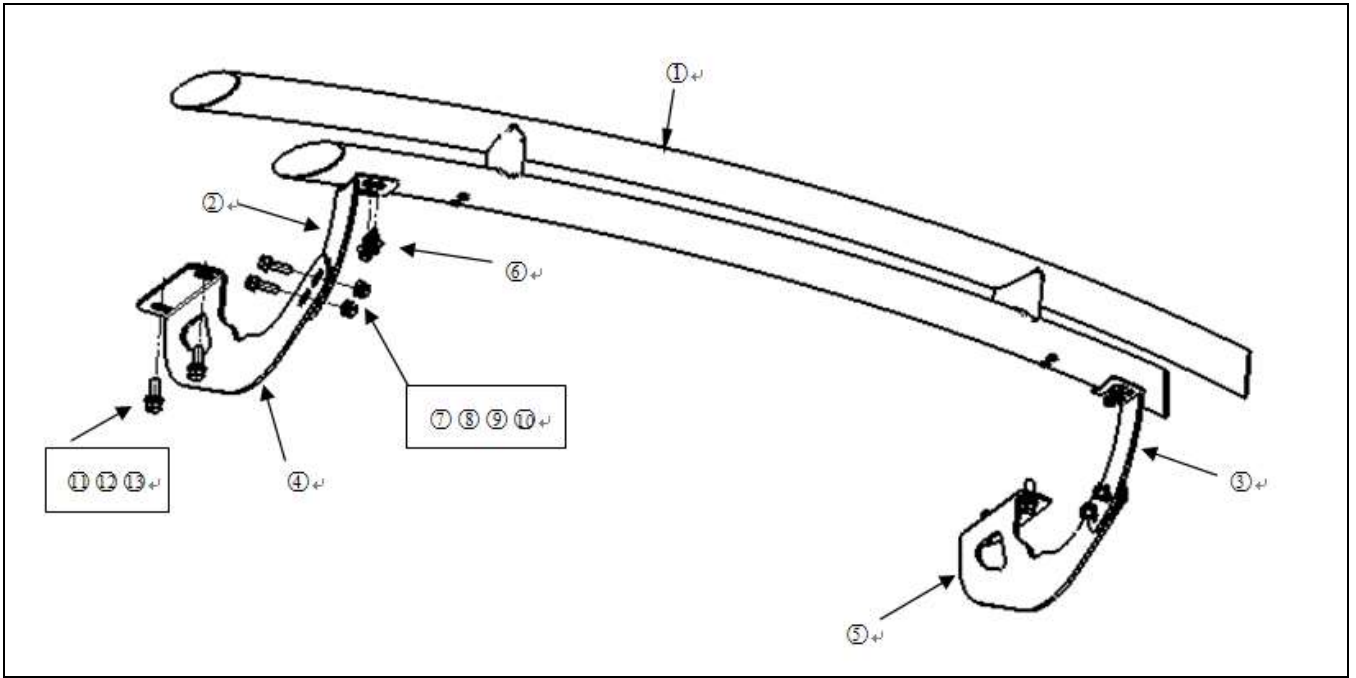

PIC2

Bracket-B-L Installation

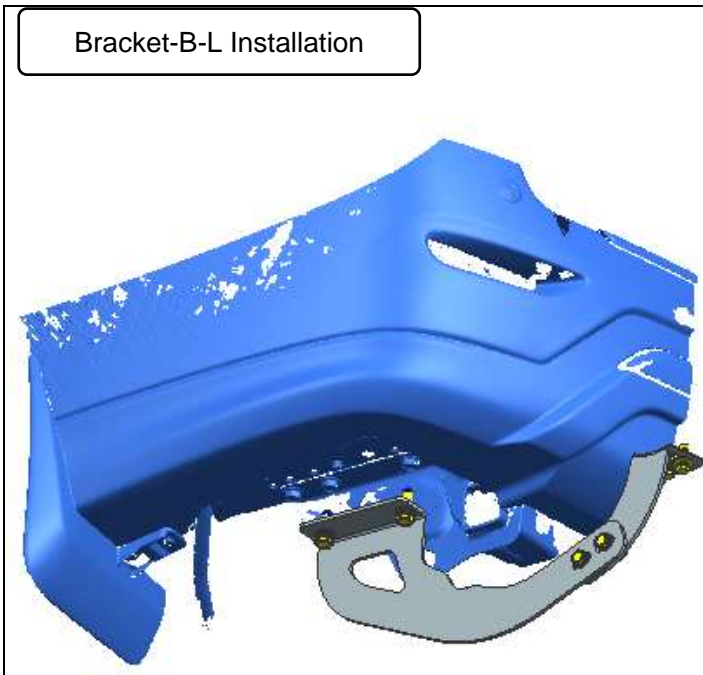

Bracket-B-R Installation

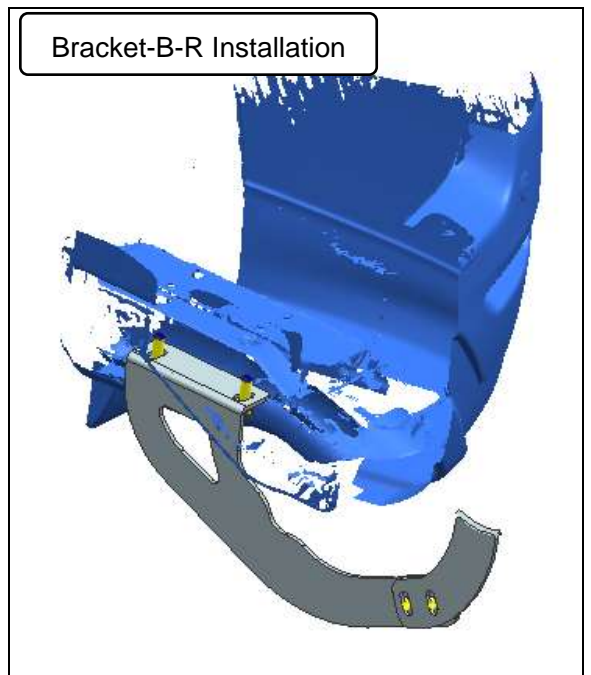

## NOTE

Any damages and losses caused by improper installation and application, goes beyond our quality warranty.