



# **INSTALLATION INSTRUCTIONS**

**MAX BEACON BULL BAR FOR JEEP PATRIOT 08-18  
PART # MAB-JEB9001S**

**PARTS LIST:**

1	Bull Bar	6	12mm Lock Washers
1	Center Bracket	4	12mm Hex Nuts
1	Driver/Left Mounting Bracket	3	10-1.50mm x 70mm Hex Bolts
1	Passenger/Right Mounting Bracket	3	10mm Lock Washers
1	Top Bracket	3	10mm x 27mm OD x 3mm Flat Washers
3	10mm Nut Plates (Use for models w/plastic splash guard only)	1	6-1.0mm x 25mm Button Head Bolt
3	38mm OD x 27mm Long Tube Spacers (Use for models w/plastic splash guard only)	1	6mm x 12mm OD x 1.6mm Flat Washer
2	12-1.75mm x 50mm Hex Bolts	1	6mm Lock Washers
4	12-1.75mm x 35mm Hex Bolts	1	Wrench
10	12mm x 32mm OD x 3mm Flat Washers		

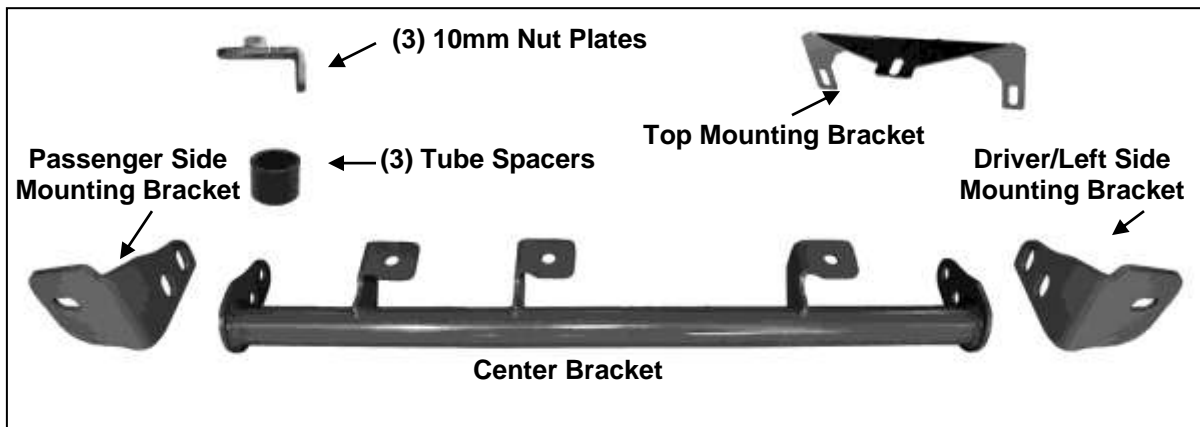
**PROCEDURE:**

1. REMOVE CONTENTS FROM BOX. VERIFY ALL PARTS ARE PRESENT. READ INSTRUCTIONS CAREFULLY BEFORE STARTING INSTALLATION. ASSISTANCE IS RECOMMENDED. CUTTING MAY BE REQUIRED.
2. **4x4 Models With Optional Steel Skid Plate – Center Bracket Installation**
  - a. Remove the three 10mm hex bolts securing the front of the steel skid plate to the lower part of the bumper, **(Figure 1)**.
  - b. Line up the holes in the tabs on the Center Bracket with the (3) factory holes in the skid plate, **(Figure 2A)**. **NOTE:** The Center Bracket will bolt over the factory steel skid plate, **(Figure 2B)**. Hang the Center Bracket from the vehicle by replacing the (3) factory hex bolts with the included (3) 10mm x 70mm Hex Bolts, (3) 10mm Lock Washers, and (3) 10mm Flat Washers.
3. **2wd & 4x4 Models With Plastic Splash Guard – Center Bracket Installation**
  - a. Remove the plastic splash guard from the vehicle. Place the splash guard on a clean, stable work surface, **(Figure 3)**.
  - b. Locate the rectangular holes in the back of the front cross member. Insert one 10mm Nut Plate into each opening. **NOTE:** Hold the Center Bracket up in location to determine the correct holes to use in the cross member. Line up the Nut Plates with the holes in the bottom of the cross member, **(Figure 4)**.
  - c. Hold the splash guard up in the approximate location. Mark the location of the (3) mounting holes for the Center Bracket onto the splash guard, **(Figure 3)**. Cut out the (3) openings to clear the mounting tabs on the Bracket. **IMPORTANT:** Do not cut completely through the front edge of the splash guard. Only remove enough material to install the Center Bracket.
  - d. Reinstall the splash guard at this time using the factory hardware. Do not tighten hardware.
  - e. With assistance, position the Center Bracket up to the vehicle and line up the holes in the bracket with the previously inserted Nut Plates. Line up the center mount on the Tube Bracket with the cross member. Place (1) Tube Spacer between the cross member and the center tab

## MAX BEACON BULL BAR FOR JEEP PATRIOT 08-18

on the Center Bracket, **(Figure 5)**. Insert (1) 10mm x 70mm Hex Bolt, (1) 10mm Lock Washer and (1) 10mm Flat Washer through the Bracket, Spacer and into the Nut Plate, **(Figure 5)**. Repeat this step for the two outer mounting locations on the Center Bracket.

- f. Tighten the factory hardware on the splash guard only.

### All Models – Mounting Bracket Installation

4. Locate the passenger and driver side Mounting Brackets. Bolt the Mounting Brackets to the Center Bracket with the included (4) 12mm x 35mm Hex Bolts, (4) 12mm Lock Washers, (8) 12mm Flat Washers and (4) 12mm Hex Nuts, **(Figure 6)**. Do not tighten hardware at this time.
5. With assistance, attach the City Bar to the Mounting Brackets with the included (2) 12mm x 50mm Hex Bolts, (2) 12mm Lock Washers and (2) 12mm Flat Washers, **(Figure 6)**. Do not tighten hardware.
6. Attach the Top Bracket to the vehicle using the (2) factory license plate screws. Use the included (1) 6mm x 25mm Allen Bolt, (1) 6mm Lock Washer and (1) 6mm Flat Washer to bolt the City Bar to the Top Bracket, **(Figure 7)**. **NOTE:** Top Bracket can be mounted in front of or behind the license plate.
7. Level and adjust the City Bar properly and tighten all hardware.
8. Do periodic inspections to the installation to make sure that all hardware is secure and tight.

**To protect your investment**, wax this product after installing. Regular waxing is recommended to add a protective layer over the finish. Do not use any type of polish or wax that may contain abrasives that could damage the finish.

**For stainless steel:** Aluminum polish may be used to polish small scratches and scuffs on the finish. Mild soap may be used also to clean the City Bar.

**For gloss black finishes:** Mild soap may be used to clean the City Bar.

4x4 Model W/Steel Skid Plate Pictured

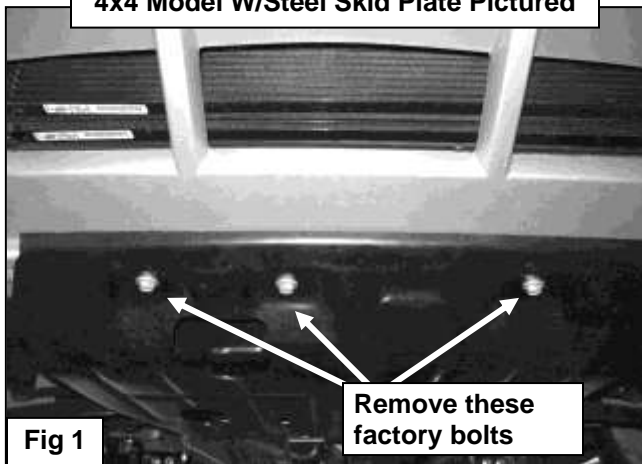

(Fig 2A) Install Cross Bar over steel skid plate

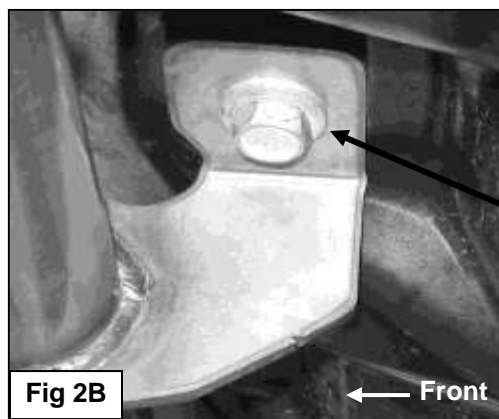

Fwd & 4x4 Model W/Plastic Splash Guard Pictured

Cut 3-1/2" openings where indicated to clear mounting tabs on Cross Bar. Double-check location before cutting.

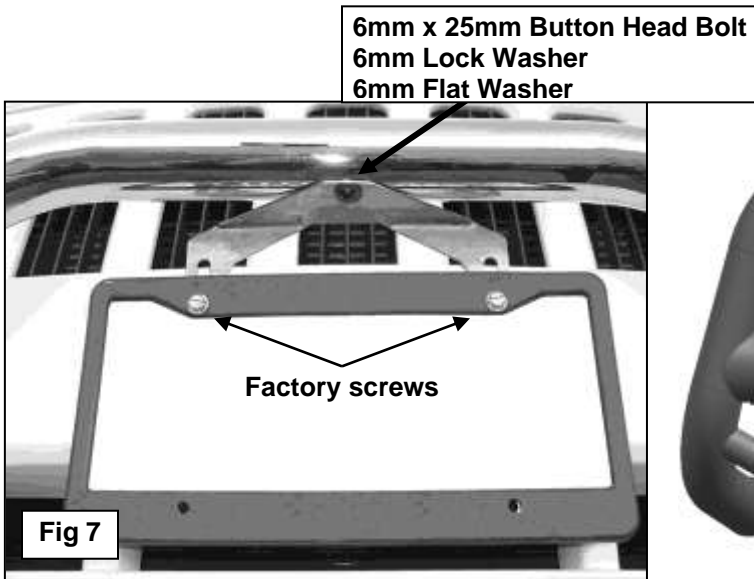
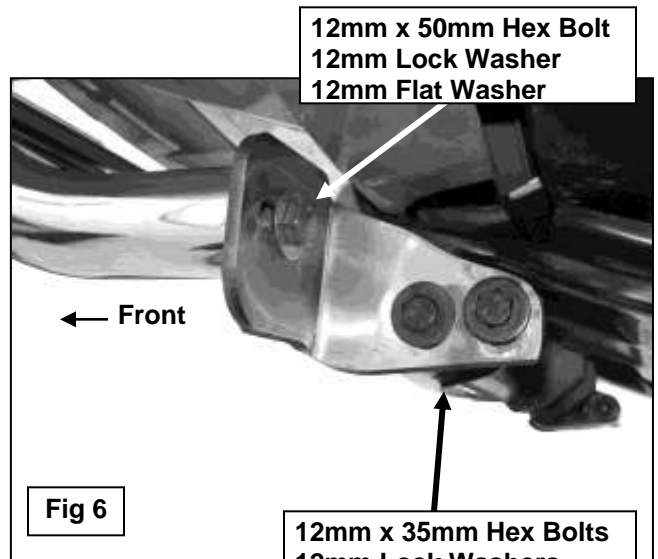
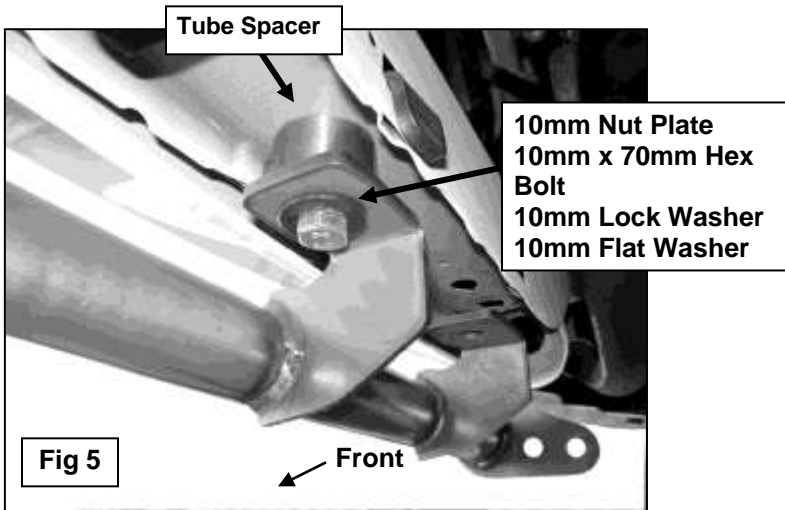
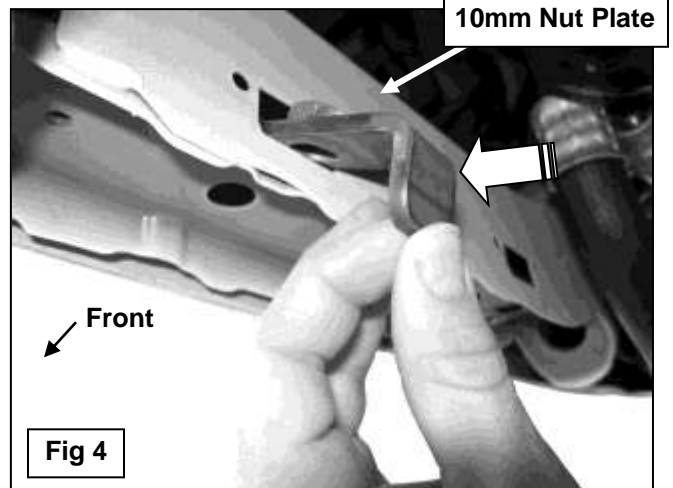
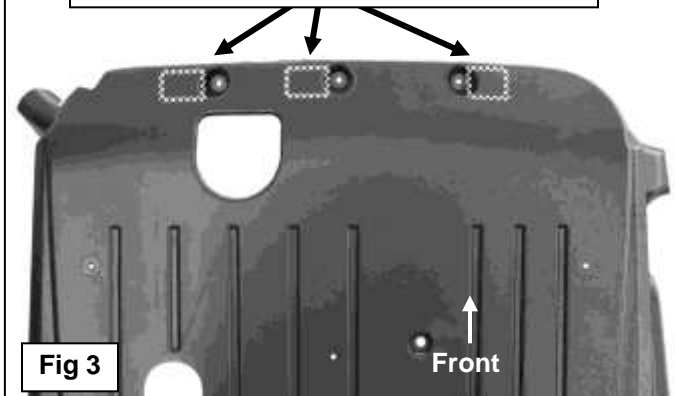

12mm x 35mm Hex Bolts  
12mm Lock Washers  
12mm Flat Washers  
12mm Hex Nuts

