

UNIVERSAL AL. BASKET COMPATIBLE WITH 56" CROSS BAR 55x45"(WITH CONNECTING BRACKET)



INSTALLATION INSTRUCTIONS















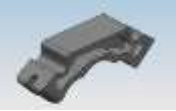

**TRAVELER CROSS BAR WITH ALUMINUM BASKET COMPATIBLE WITH 56" CROSS BAR
55x45"(WITH CONNECTING BRACKET)**

For

2013-2021 Chevrolet Silverado / 2015-2021 Ford F150 /2013 -2021 Dodge Ram 1500

PART # TRRB160S

Parts list

NO.	QTY	PICTURE	NO.	QTY	PICTURE	NO.	QTY	PICTURE
①	2	 Front mounting part	②	2	 Side mounting part	③	5	 Middle mounting part
④	2	 LED light mounting bracket	⑤	4	 Square head bolt M8_18	⑥	4	 Connecting bracket
⑦	4	 Connect cover	⑧	8	 Lock nut	⑨	4	 U Bolt
⑩	18	 Hex nut M8	⑪	38	 Flat washer D8(8x24x2mm)	⑫	20	 Lock washer D8
⑬	20	 Assembly bolt M8_25	⑭	14	 Hex flat round head bolt M8_30	⑮	2	 Hex bolt M8_20
⑯	1	 Allen wrench S=5						

Installation Figure

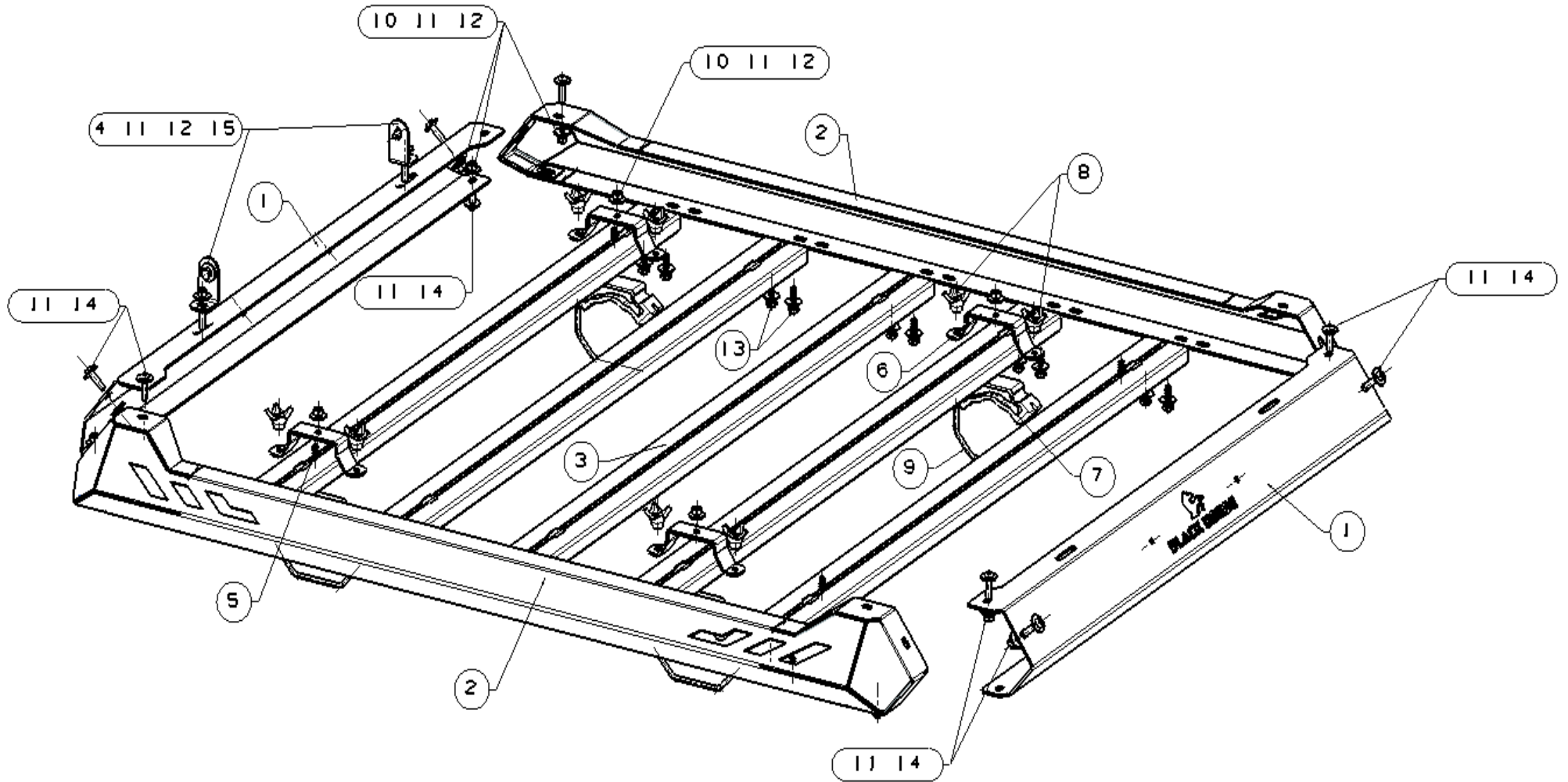

Install roof rack:

Use ① Flat washer D8(8x24x2mm), ⑭ Hex flat round head bolt M8_30, ⑩ Hex nut M8, ① Flat washer D8(8x24x2mm) and ⑫ Lock washer D8 to install ① Front mounting part with ② Side mounting part. And then use ⑬ Assembly bolt M8_25 to install ② Side mounting part with ③ Middle mounting part.

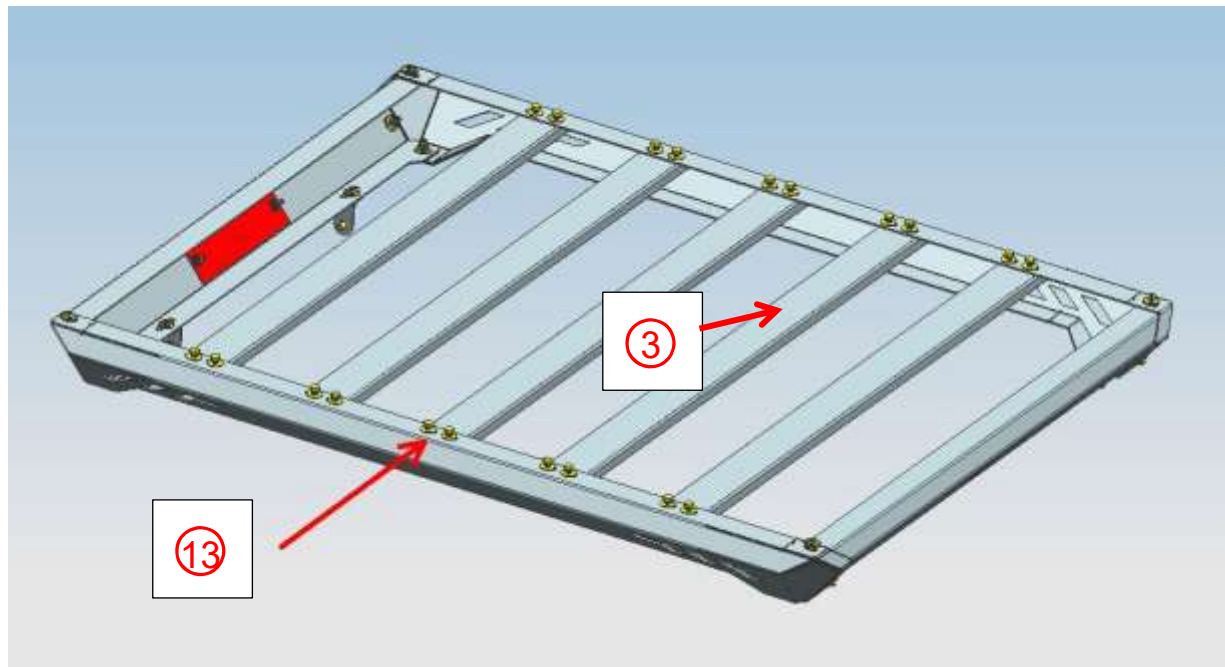
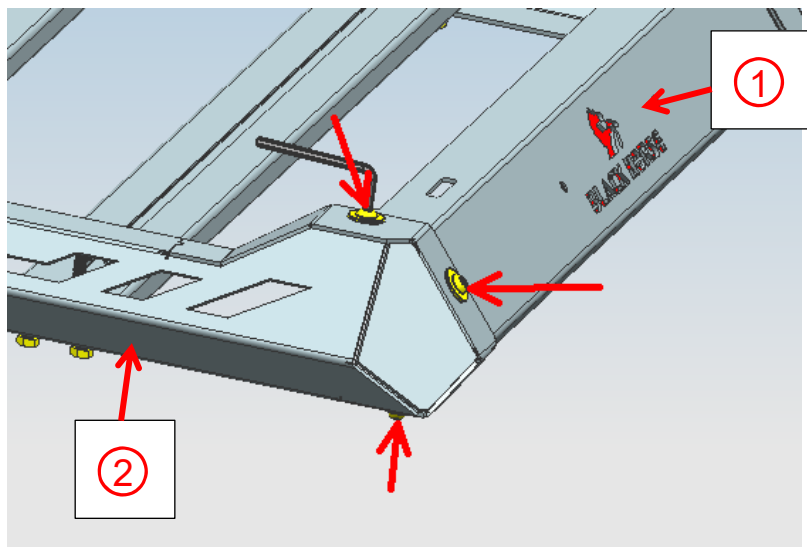

Install connecting bracket:

Use ⑩Hex nut M8, ⑪Flat washer D8(8x24x2mm), ⑫Lock washer D8 and ⑤ Square head bolt M8_18 to install ③ Middle mounting part with ⑥ Connecting bracket. And then use ⑧Lock nut and ⑨U Bolt to install ⑥ Connecting bracket with ⑦ Connect cover.

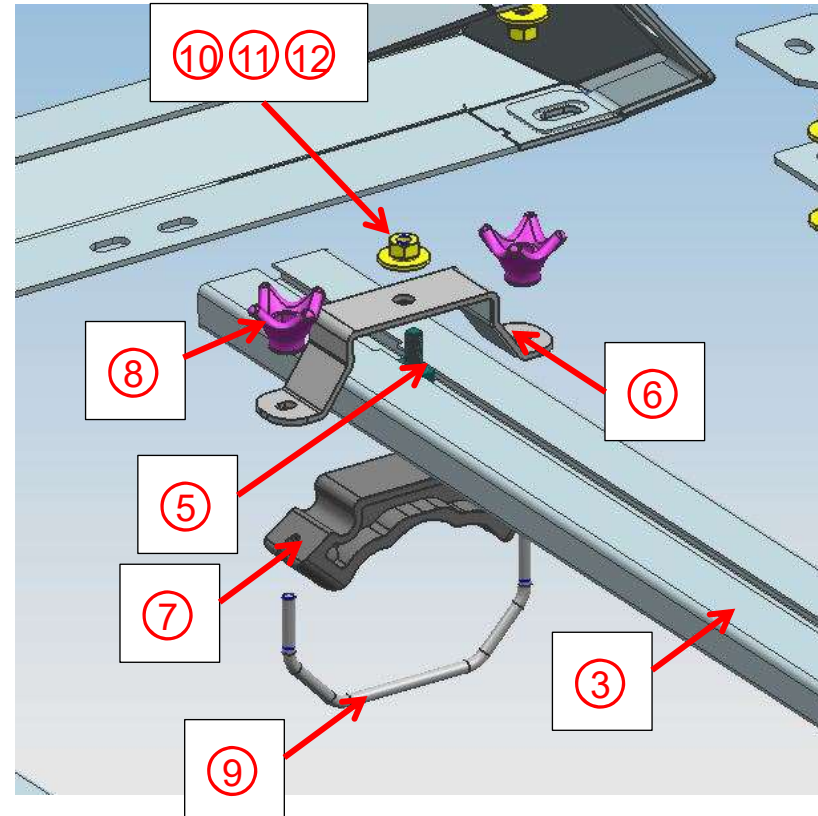

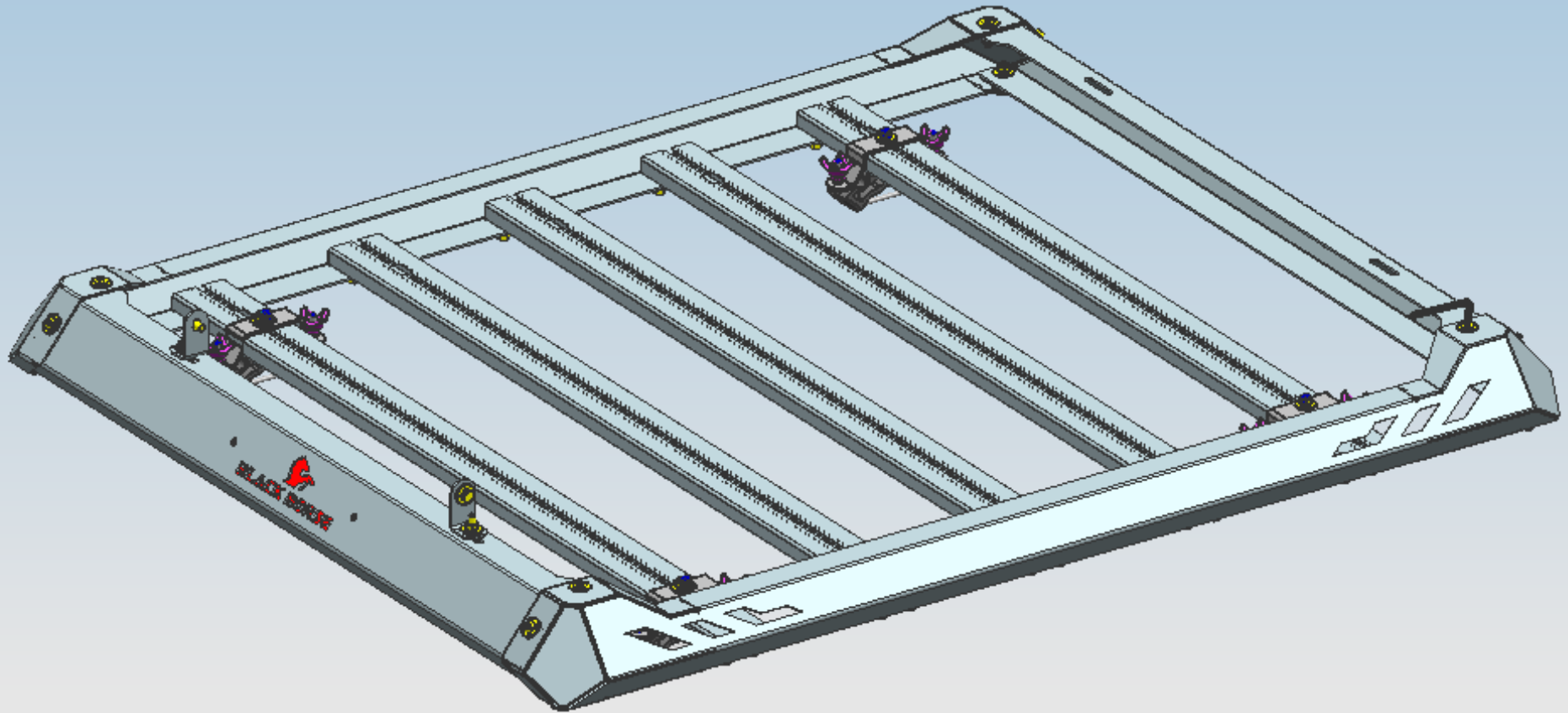

Complete Installation