

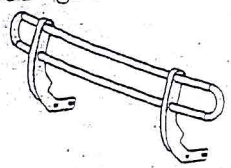





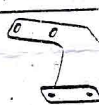

INSTALLATION INSTRUCTION  
 GRILLE GUARD FOR NISSAN 2012  
 ITEM NO: 8NIJUA

ATTENTION

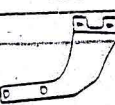
1. Please read this installation instruction before installing this Rear guard.  
 When install it, please pay attention to protecting your Rear guard.
2. When you use it, please check this Rear guard at a fix time-lapse, such as one month or two month.

PARTS LIST

No	Name	Photo	Qty	Remarks	No	Name	Photo	Qty	Remarks
A	rear guard 		1		G	M12 nut		4	M12
					H	M10X30 bolt		1	M10
B	mount bracket lateral symmetry		1	T=5	I	M10lock washer...4		1	M10
C	mount bracket lateral symmetry		1	T=5	J	M10lock washer		1	M10X30
D	M12X30 bolt		4	M12X30					
E	M12lock washer		8	M12					
F	M12lock washer		4	M12					

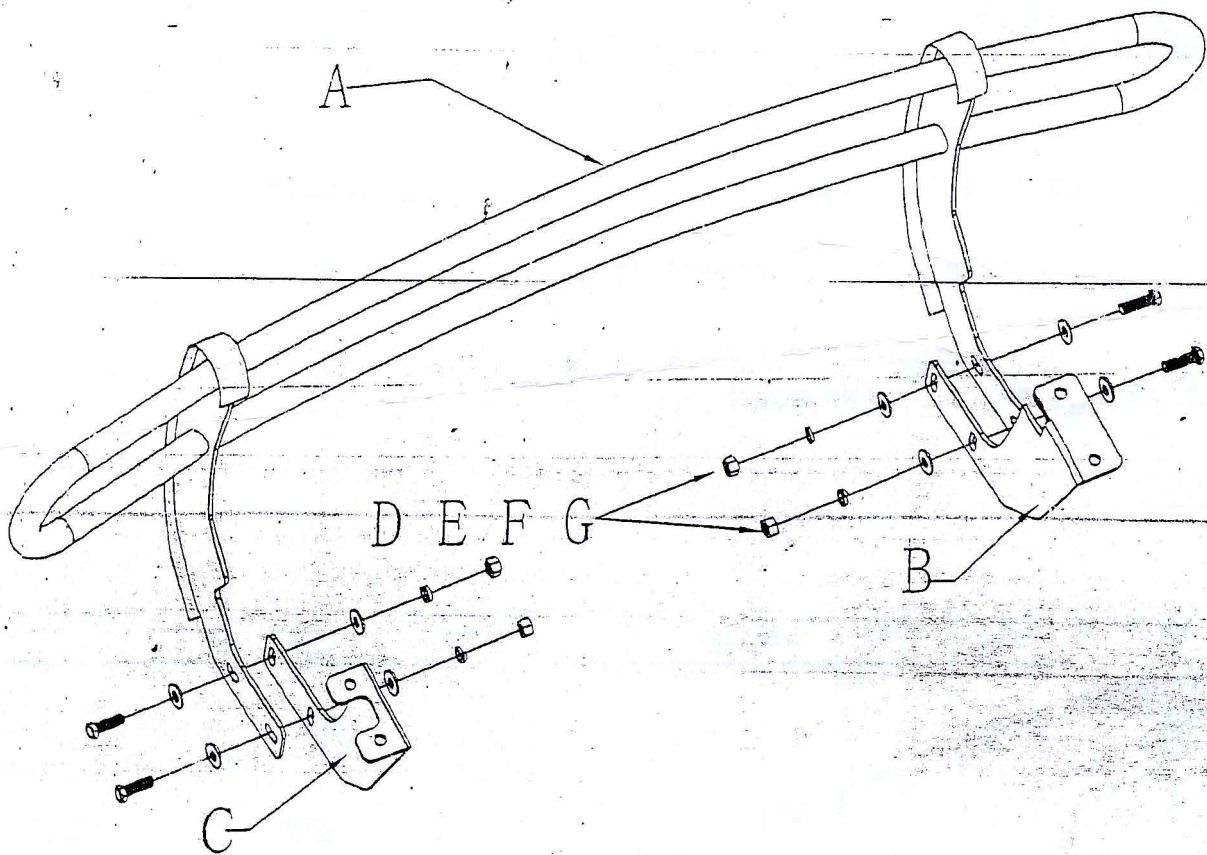

**INSTALLATION STEPS**

- STEP 1: Check the parts in the box carefully if match above list;
- STEP 2: Pls prepare the tools for installation, follow as: 14-17wrench, 17-19 wrench;
- STEP 3: Put the mount bracket into the girder of the car, and tighten it with the M10"U" bolt;
- STEP 4: Install the Rear guard to the mount bracket, with M12X30 hex bolt;
- STEP 5: Installation is finished.