



INSTALLATION INSTRUCTIONS

**BLACK CLASSIC ROLL BAR FOR 09-18 DODGE RAM 1500 FLAT
BASE WITH LED BRAKE LIGHT**

PART #RB002BK







Before Installation

- Please read the instruction completely for easy installation, which will also help you to avoid scratches or other potential damages to your appealing car.
- The information shown here is for reference only and may differ from the product that you receive, however the goods are fitted in the same way.

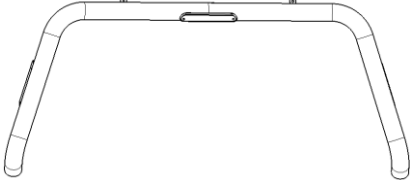



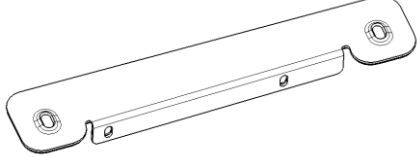
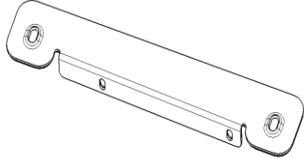

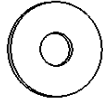

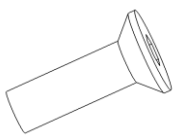

Care and Cleaning

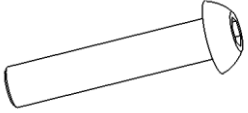
- Mild soap may be used also to clean the Product.
- Please periodically check and retighten all the hardware and clean the investment for a refresh look.

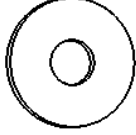
Parts list

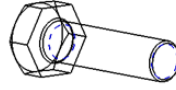
NO.	QTY	PICTURE	NO.	QTY	PICTURE
①	1	 Pipe 1	②	1	 Pipe 2
③	1	 Decoration plate-L	④	1	 Decoration plate-R
⑤	1	 Connecting plate (FOR LED LIGHT INSTALLATION)	⑥	1	 Support bracket L
⑦	1	 Support bracket R	⑧	1	 Allen wrench S=8
⑨	1	 Allen wrench S=4	⑩	16	 Flat washer D6

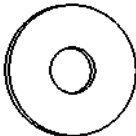
BLACK CLASSIC ROLL BAR FOR 09-18 DODGE RAM 1500 FLAT BASE WITH LED BRAKE LIGHT

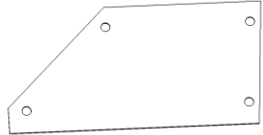
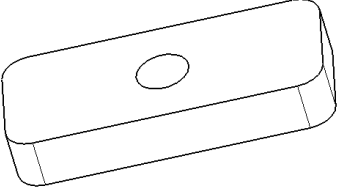
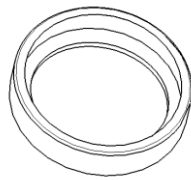
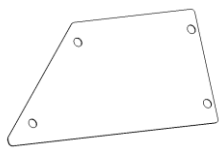
⑪	8	 Spring washer D6	⑫	4	 Countersunk head allen bolts M12-40
⑬	8	 Hex nut M6	⑭	2	 Button head allen bolts M8-40
⑮	8	 Button head allen bolts M6-20	⑯	4	 Spring washer D12
⑰	8	 Flat washer D12	⑱	4	 Hex nut M12
⑲	4	 Hex nut M12*40	⑳	2	 Hex nut M8
㉑	4	 Flat washer D8	㉒	2	 Spring washer D8
㉓	1	 Allen wrench S=5	㉔	2	 Red decoration plate
㉕	2	 Block	㉖	4	 Gum cover
㉗	2	 Decoration plate backboard			

Installation Steps

Installation Figure:

Step 1: Verify all parts are present.

Step 2: Use wrench 23 to install 1/2 main pipes and connecting plate 5 together with parts 14/20/21/22/25 as shown.

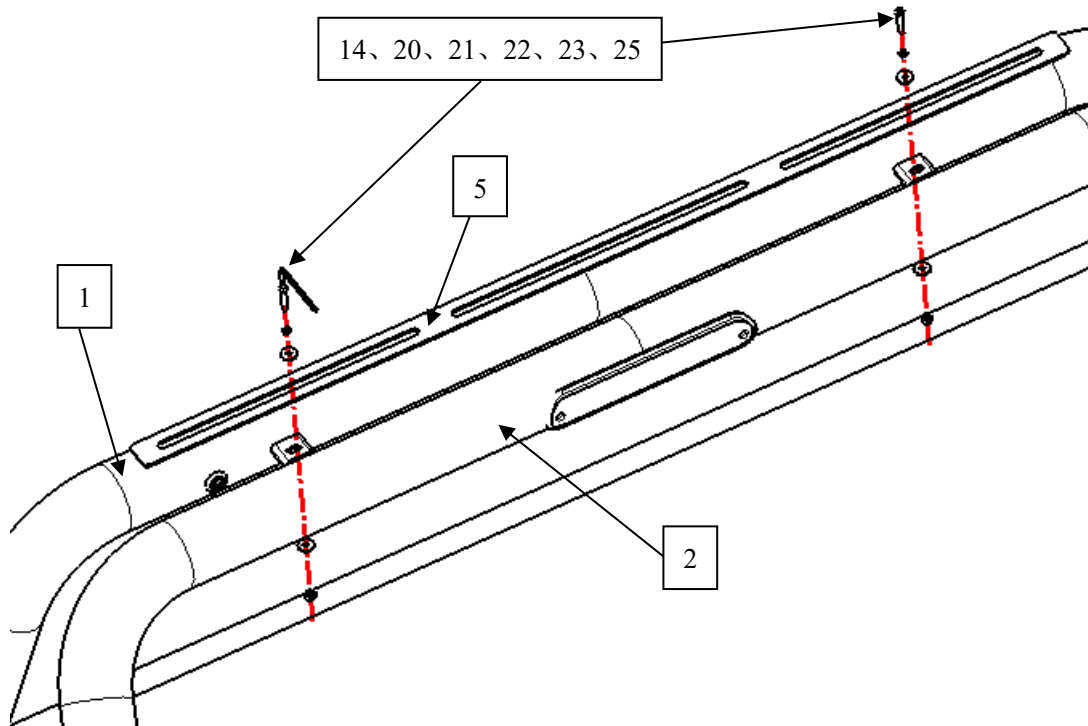

Step 3: Using wrench 9, install 3/4 decoration plate together with parts 10/11/13/15 as shown.

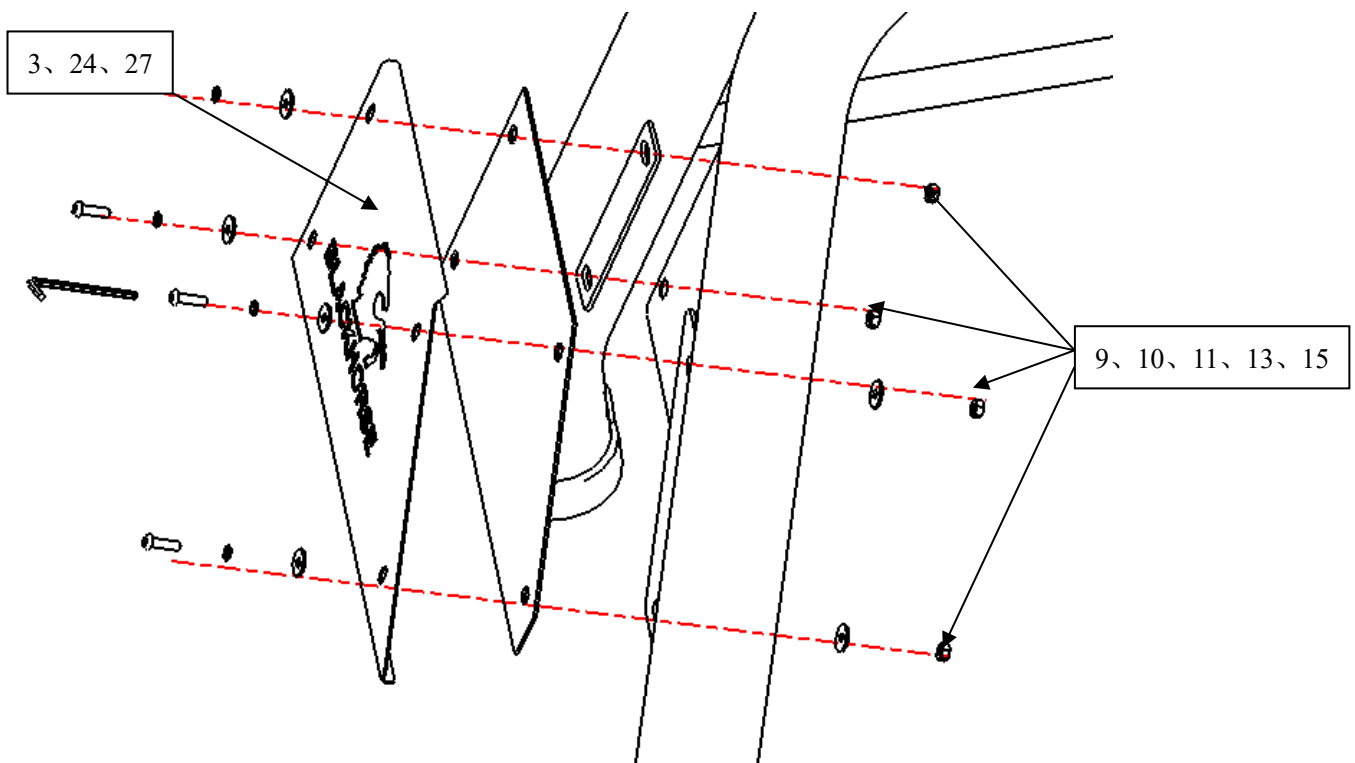

Step4: Using wrench 8, install support plate 6 and gum cover 26 with part 12.

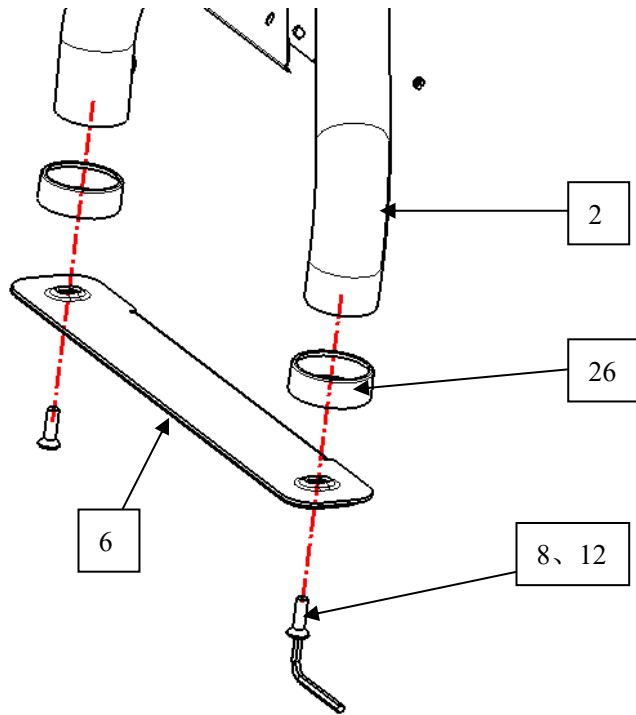

Step 5: Fix the roll bar on the trunk with parts 16/17/18/19 (need to drill the trunk if there's no installation holes). Test and make sure that the roll bar is steadily fixed, and then tighten all the hardware.

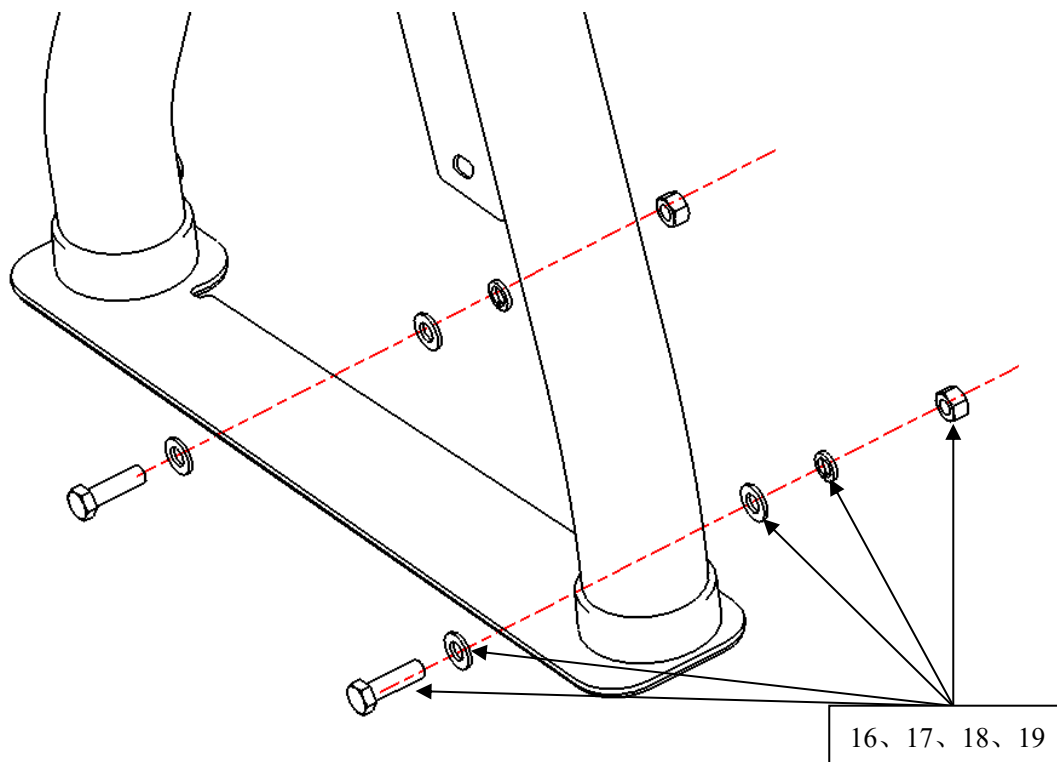

Step 6: Installation is finished, pick up all tools.

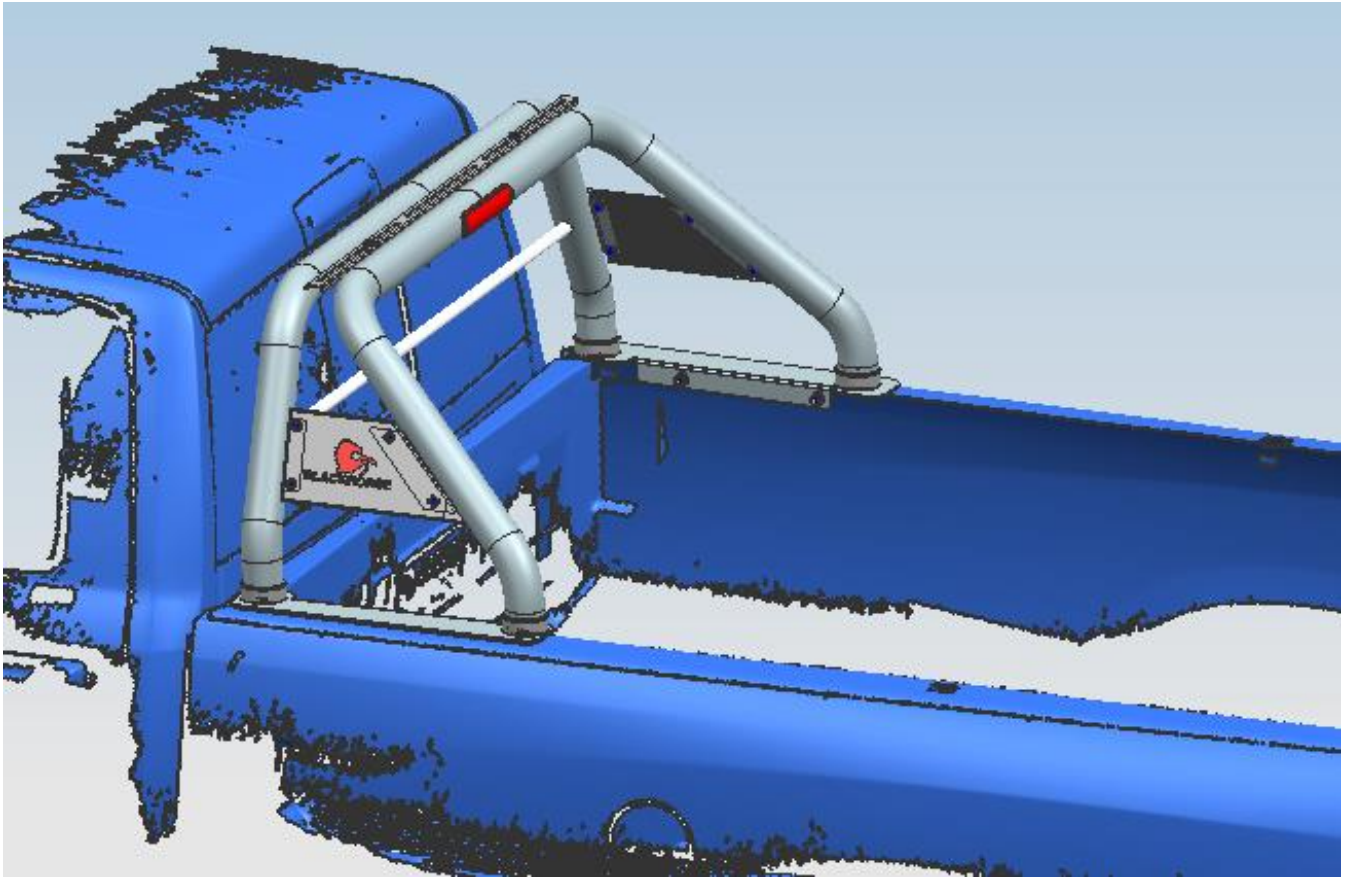

NOTE

Any damages and losses caused by improper installation and application, goes beyond our quality warranty.