

INSTALLATION INSTRUCTIONS



BLACK HORSE ROLL BAR FOR 1/2 TON TRUCKS 2015-2021 Nissan Frontier

AT BASE WITH LED BRAKE LIGHT Compatible with Tonneau covers

Before Installation

- Please read the instruction completely for easy installation, which will also help you to avoid scratches or other potential damages to your appealing car.
- The information shown here is for reference only and may differ from the product that you receive, however the goods are fitted in the same way.







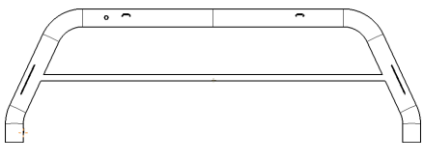
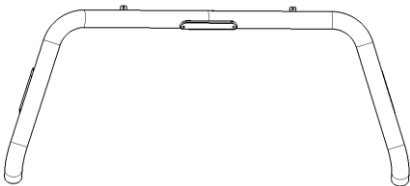
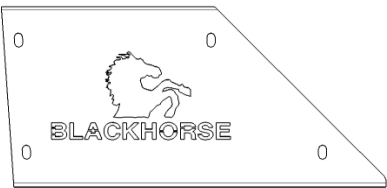
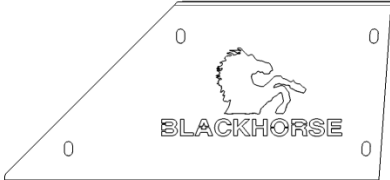
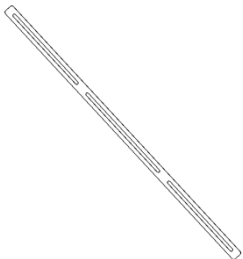
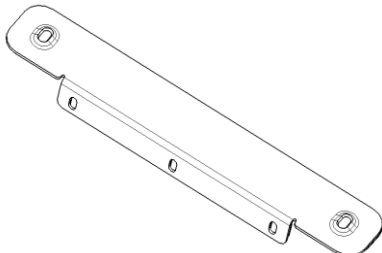

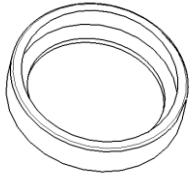

Care and Cleaning

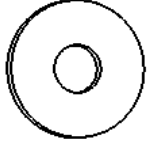
- Mild soap may be used also to clean the Product.
- Please periodically check and retighten all the hardware and clean the investment for a refresh look.

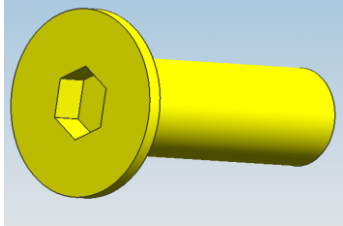
Parts list

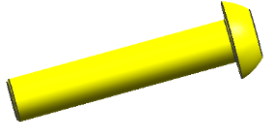
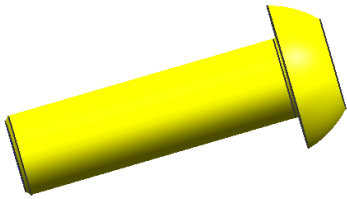
NO.	QTY	PICTURE	NO.	QTY	PICTURE
①	1	 Pipe 1	②	1	 Pipe 2
③	1	 Decoration plate-L	④	1	 Decoration plate-R
⑤	2	 Connecting plate (FOR LED LIGHT INSTALLATION)	⑥	2	 Support plate

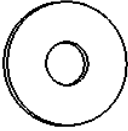
INSTALLATION INSTRUCTIONS

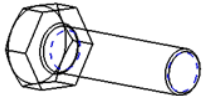
⑦	1	 Allen wrench S=8	⑧	4	 Gum cover
⑨	1	 Allen wrench S=4	⑩	20	 Flat washer D6
⑪	10	 Spring washer D6	⑫	4	 Button head allen bolts M12-40
⑬	10	 Hex nut M6	⑭	2	 Button head allen bolts M6-30
⑮	8	 Button head allen bolts M6-20	⑯	6	 Spring washer D12
⑰	12	 Flat Washer D12	⑱	6	 Hex nut M12
⑲	6	 Hex nut M12*40			

INSTALLATION INSTRUCTIONS

Installation Fig.

Step 1: Verify all parts are present.

Step 2: Using wrench 9, install 1/2 main pipes and connecting plate 5 together with parts 10/11/13/14 as shown.

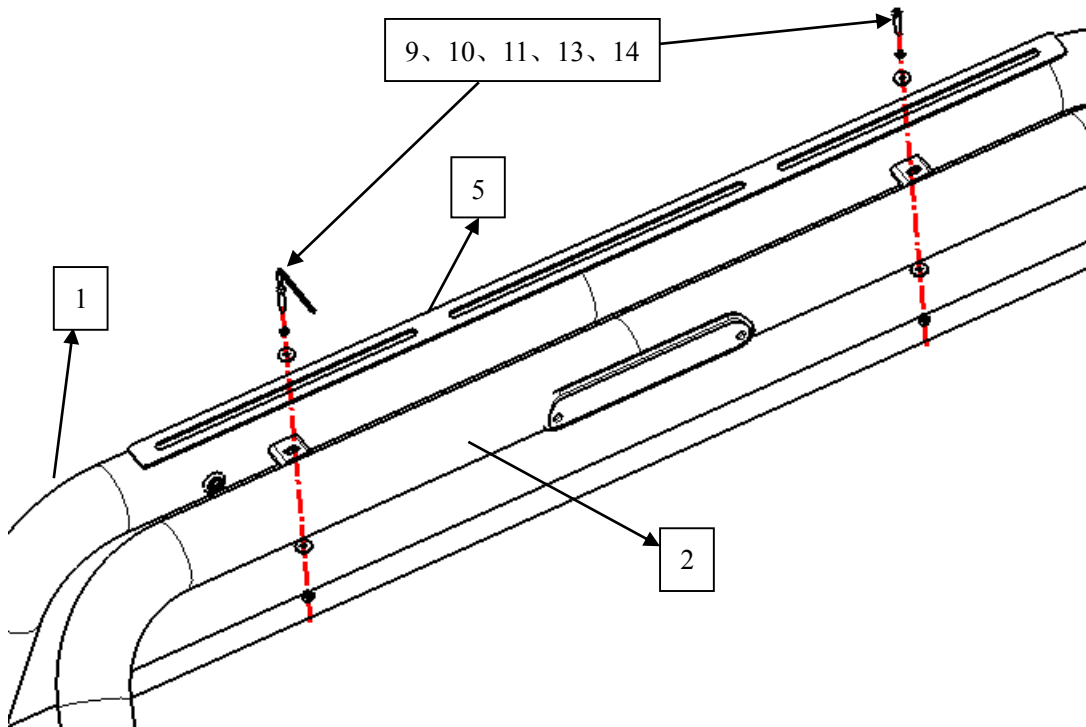

Step3: Using wrench 9, install 3/4 decoration plate together with parts 10/11/13/15 as shown.

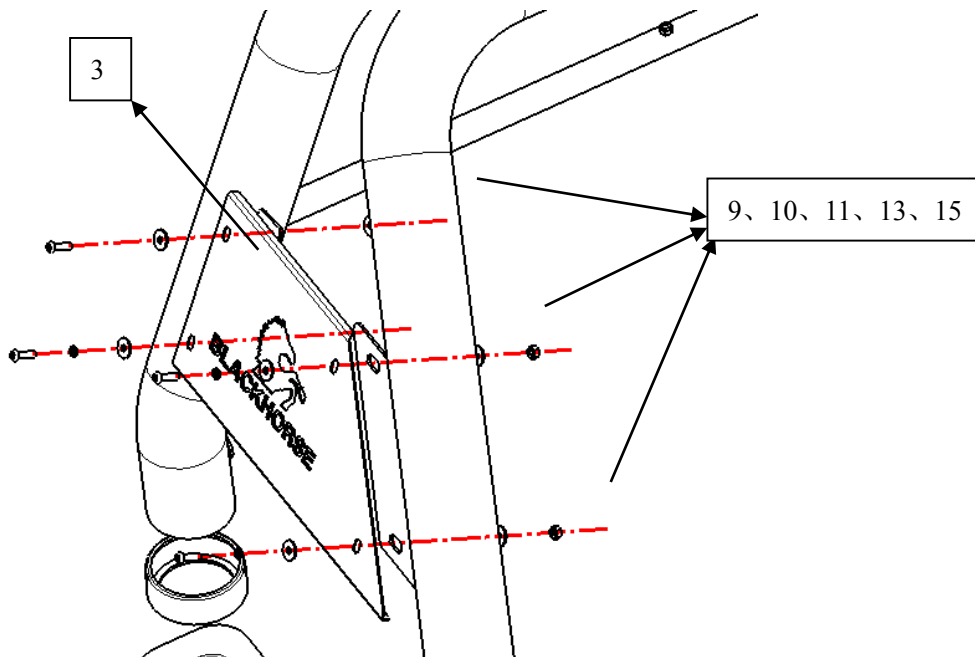

Step4: Using wrench 7, install support plate 6 and gum cover 8 with part 12.

INSTALLATION INSTRUCTIONS

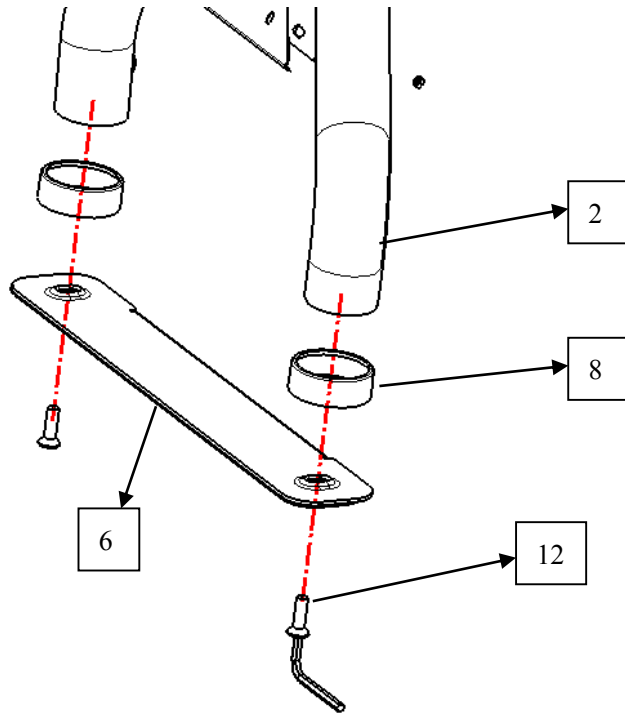

Step 4: Fix the roll bar on the trunk with parts 16/17/18/19 (need to drill the trunk if there's no installation holes). Test and make sure that the roll bar is steadily fixed, and then tighten all the hardware.

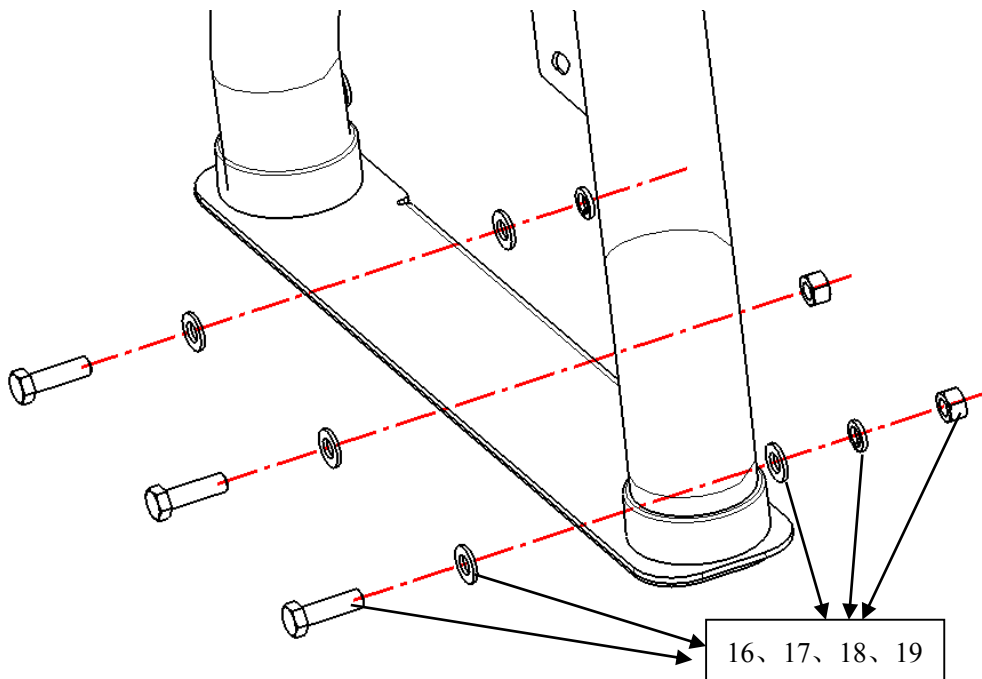

Step 6: Installation is finished, pick up all tools.

INSTALLATION INSTRUCTIONS

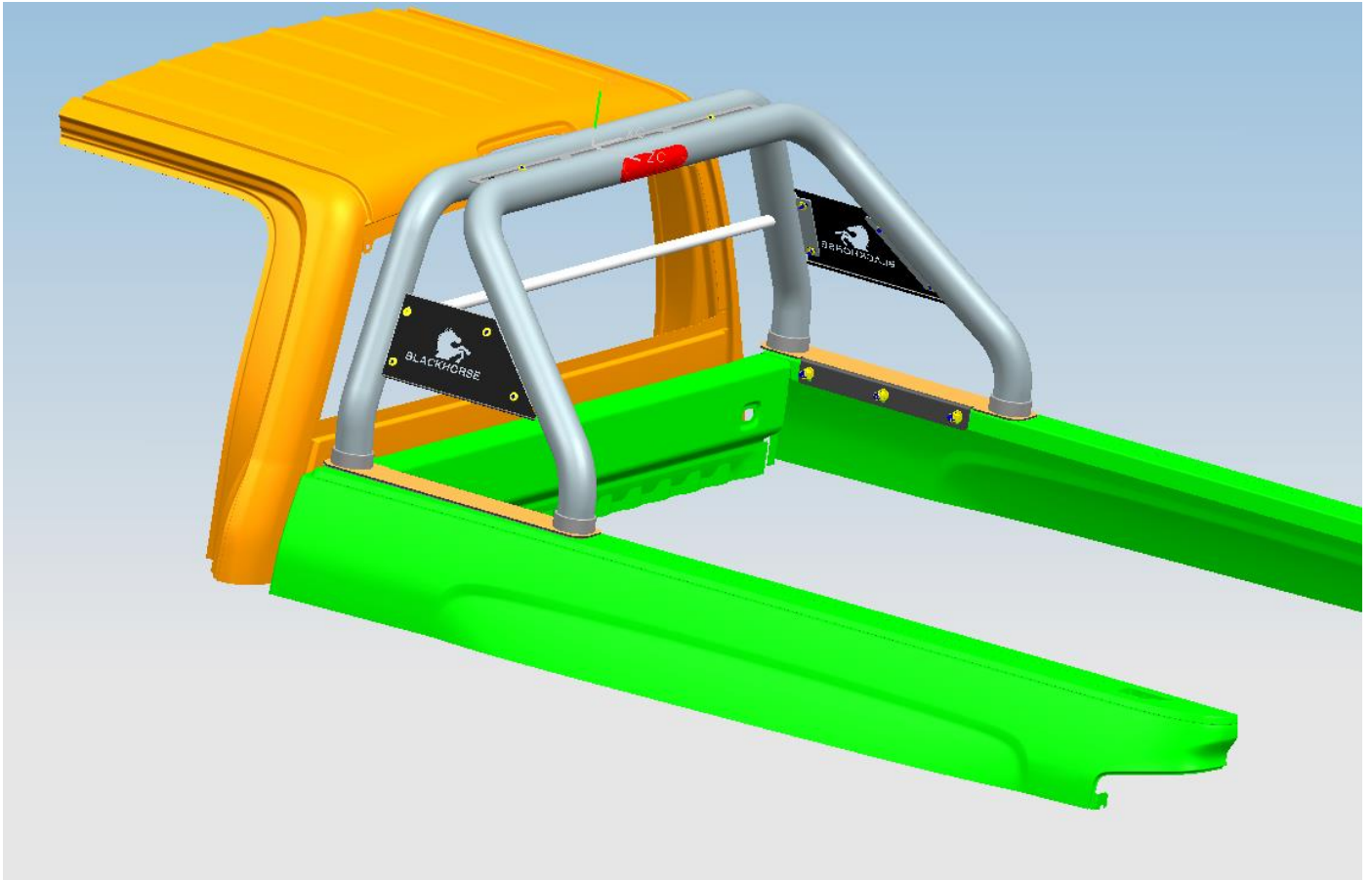

NOTE

Any damages and losses caused by improper installation and application, goes beyond our quality warranty.