

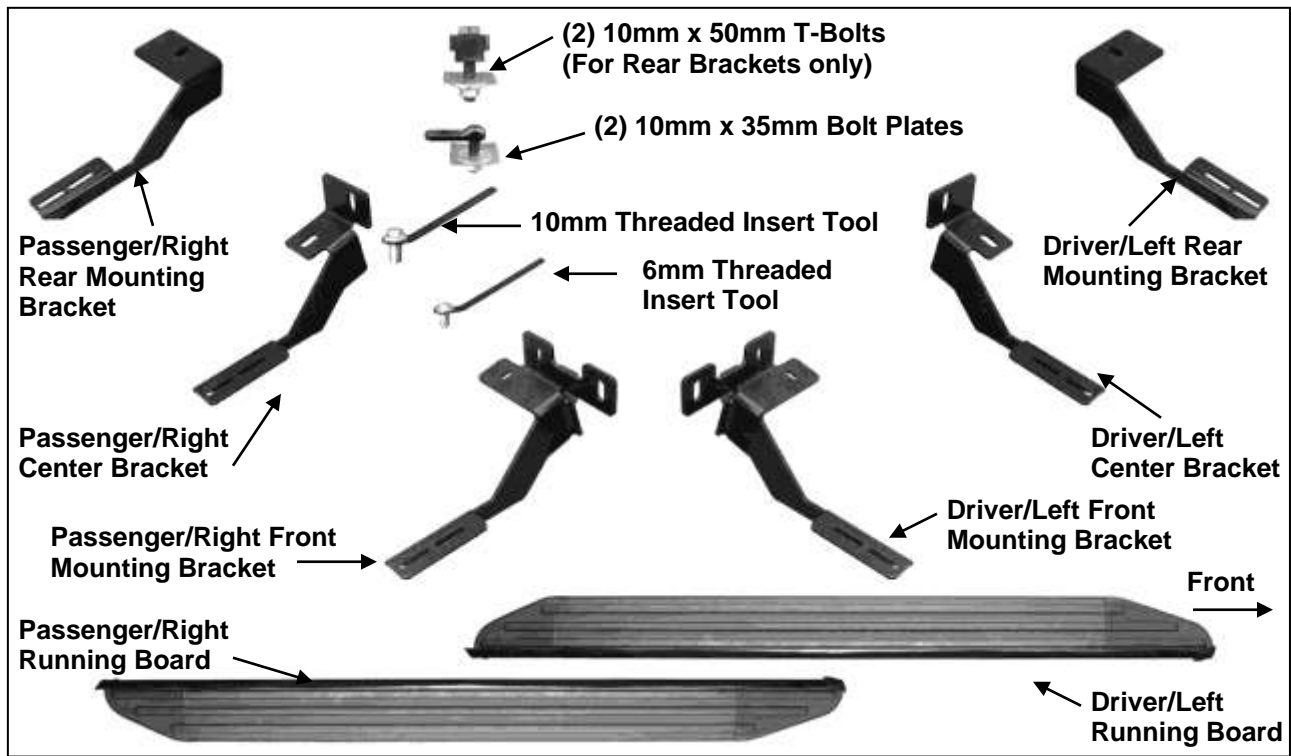

INSTALLATION INSTRUCTIONS
EXCEED RUNNING BOARD FOR LEXUS RX350 10-15
PART # EX-LX250E

PARTS LIST:

1	Driver Side Running Board	4	10mm Plastic Retainer
1	Passenger Side Running Board	2	10mm x 50mm "T" Bolts (Rear Bracket only)
1	Driver Side Front Mounting Bracket	2	10mm x 35mm Button Head Bolt Plates
1	Passenger Side Front Mounting Bracket	4	10mm x 25mm Hex Bolts
1	Driver Side Center Mounting Bracket	2	10mm x 34mm x 3mm Large Flat Washers
1	Passenger Side Center Mounting Bracket	6	10mm x 27mm x 3mm STD Flat Washers
1	Driver Side Rear Mounting Bracket	4	10mm Lock Washers
1	Passenger Side Rear Mounting Bracket	4	10-1.5mm Serrated Flange Nuts Gr 8.8
1	10mm Insert Installing Tool	12	6mm x 20 mm "T" Bolts (Running Board)
1	6mm Insert Installing Tool	4	6-1.0mm x 25mm Hex Head Bolts
4	10-1.5mm Threaded Inserts	16	6mm x 22mm OD x 2mm Flat Washers
3	6-1.0mm Threaded Inserts	16	6mm Lock Washers
		12	6mm Hex Nuts



PROCEDURE:

1. REMOVE CONTENTS FROM BOX. VERIFY ALL PARTS ARE PRESENT. READ INSTRUCTIONS CAREFULLY BEFORE STARTING INSTALLATION. CUTTING IS REQUIRED. DRILLING IS REQUIRED. ASSISTANCE IS RECOMMENDED. PLEASE NOTE: 200LBS IS THE MAXIMUM RATED LOAD FOR THE VIEWPOINT RUNNING BOARDS.
2. Start installation under the driver side front of the vehicle. Remove the plastic covers, (Fig. 1). Pay close attention to the type and location of all factory hardware for reinstallation.
3. Locate the (2) factory holes in the inside wall of the floor panel, (Fig. 1). **NOTE:** The mounting locations may be covered by rubber plugs, sealant and/or undercoating. **IMPORTANT:** Scrape any excess sealant from body panel before installing any and all Brackets.
4. Select (1) 10mm Threaded Insert, (1) 10mm Insert Tool, (1) 10mm x 25mm Hex Bolt and (1) 10mm x 27mm STD Flat Washer. Assemble the Threaded Insert as pictured in Figure 2. Insert the Threaded Insert assembly into the forward, larger hole in the inner body panel, (Fig. 4). **NOTE:** If Insert fits too tight, enlarge hole by drilling with a 1/2" drill bit. **IMPORTANT:** Be careful not to enlarge hole too much. Insert should fit snug in hole and lip on Insert should be against sheet metal surface.

5. Hold the assembly in place by the handle on the Tool and apply pressure to keep the Insert in the hole. Tighten the Hex Bolt on the assembly until Insert is fully compressed/expanded and locked in place, **(Fig. 3)**. **NOTE:** Do not over tighten or Insert failure or pull out may occur. Once the Threaded Insert is fully compressed, remove the Hex Bolt and Tool. Repeat **Steps 4 & 5** for all Threaded Insert installations.
6. Next, assemble (1) 6mm Threaded Insert and Tool as previously described. Insert the 6mm Threaded Insert assembly into the small hole 4" back from the first Insert installation in **Steps 4 & 5**.

Driver/left front Bracket installation:

Remove the 6mm factory hex bolt holding the bracket for the plastic cover up to the bottom of the frame channel, **(Fig. 4)**. Select the driver side front Mounting Bracket. Slide the mounting tab on the Bracket under the factory bracket. Bolt the Mounting Bracket to the 10mm Threaded Insert with (1) 10mm x 25mm Hex Bolt, (1) 10mm Lock Washer, (1) 10mm x 27mm STD flat washer. Attach the Bracket to the 6mm Threaded Insert with (1) 6mm x 25mm Hex Bolt, (1) 6mm Lock Washer and (1) 6mm Flat Washer. Replace the factory 6mm bolt with (1) 6mm x 25mm Hex Bolt, (1) 6mm Lock Washer and (1) 6mm Flat Washer, **(Fig. 5)**. Snug but do not fully tighten hardware at this time.

Passenger/right front Bracket installation:

Repeat **Steps 2 - 6** to install the Inserts for the passenger side front Bracket but note that there is no 6mm hex bolt on the bottom of the body panel, **(Fig. 6 & 7)**. Install the passenger side front Bracket as previously described in driver side installation, **(Fig. 8)**. Mark the location of the bottom mounting tab onto the bottom of the floor panel. Drill a 3/8" hole in the marked location. Install (1) 6mm Threaded Insert. Secure the bottom tab to the Threaded Insert with (1) 6mm x 25mm Hex Bolt, (1) 6mm Lock Washer and (1) 6mm Flat Washer, **(Fig. 9)**.

7. Move to the center mounting location. Remove the plastic plug on the inside of the frame channel approximately 31-1/2" back along the floor panel from the front wheel opening, **(Fig. 10B)**. Select (1) 10mm Button Head Bolt Plate and (1) 10mm Plastic Retainer, **(Fig. 10A)**. Partially thread the Retainer onto the Bolt Plate. Insert the Bolt Plate into the factory hole, **(Fig. 10B)**. Thread the Retainer down tight against the sheet metal. **IMPORTANT:** The Plastic Retainer is designed to prevent the Bolt Plate from falling into the body cavity and to aid Bracket installation.

Driver/left center Bracket installation:

Remove the plastic plug on the bottom of the floor panel. Select (1) 10mm Threaded Insert and assemble the insert tool, **(Fig. 10B)**. Push the Insert into the hole in the bottom of the floor panel and install as previously described. **NOTE:** It may be necessary to enlarge hole slightly as described in **Step 4**.

Hold the driver side center Mounting Bracket up in place and attach it to the Bolt Plate with (1) 10mm STD Flat Washer and (1) 10mm Flange Nut. Secure the Bracket to the 10mm Threaded Insert with (1) 10mm x 25mm Hex Bolt, (1) 10mm Lock Washer and (1) 10mm STD Flat Washer, **(Fig. 11)**. Snug but do not fully tighten hardware at this time.

Passenger/right center Bracket installation:

Repeat **Step 7** to install the passenger side Center Bracket but note that there is no factory hole in the bottom of the frame channel, (similar to front Bracket install in **Step 6**). Bolt the Bracket to the Bolt Plate as previously described with the Bracket tight against the bottom of the frame channel, **(Fig. 12)**. Mark the slot location onto the bottom of the channel, **(Fig. 13)**. Remove the Center Bracket. Drill a 1/2" hole in the marked location. Install the 10mm Threaded Insert into the hole as previously described, **(Fig. 14)**. Reinstall the Bracket. Bolt the Bracket to the 10mm Insert with (1) 10mm x 25mm Hex Bolt, (1) 10mm Lock Washer and (1) 10mm STD Flat Washer, **(Fig. 11)**. Snug but do not tighten hardware.

8. Move to the rear mounting location and locate the large oval hole in the floor panel, **(Fig. 15)**. Remove rubber plug. Select (1) 10mm T-Bolt and (1) 10mm Plastic Retainer, **(Fig. 16A)**. Partially thread the Retainer onto the T-Bolt. Insert the T-Bolt into the oval hole in the floor panel and rotate Bolt 90-degrees so that the Block is across the oval hole, **(Fig. 16B)**. Thread the Retainer down until it is tight against the floor panel, **(Fig. 17)**. Select the driver side rear Mounting Bracket. Secure the Bracket to the T-Bolt with (1) 10mm x 34mm Large Flat Washer and (1) 10mm Flange Nut, **(Fig. 18)**. Snug but do not fully tighten hardware at this time.

9. Carefully unwrap and select the driver side Running Board. Insert (3) 6mm T-Bolts into each slot in the end of the channels, (3 T-Bolts per channel), on the bottom of the Running Board, **(Fig. 19)**. Hold the Running Board up in approximate position and slide the T-Bolts down to line up with the (3) Mounting Brackets. Tilt the Board up at a slight angle and push back against the vehicle until the T-Bolts fit into the slots on the Brackets. Secure the Board to the Brackets with (6) 6mm Flat Washers, (6) 6mm Lock Washers and (6) 6mm Hex Nuts, **(Fig. 20)**. Do not tighten hardware at this time. **NOTE:** the Running Board is designed to fit close to the vehicle. It may be necessary to temporarily loosen the Bracket hardware and tilt the Brackets downward to insert the Running Board.
10. Level and adjust the Running Board as desired and tighten all hardware, **(Fig. 21)**. Once all hardware has been tightened, hold the plastic covers removed in **Step 2**, up in position, **(Fig. 22A & 22B)**. Trace the location of the front and center Brackets onto the covers, **(Fig. 23A & 24A)**. Carefully cut the plastic covers to clear the Brackets, **(Fig. 23B & 24B)**. **IMPORTANT:** Cut as little as possible from the covers. Reinstall the plastic covers with factory hardware. Tighten all hardware.
11. Repeat **Steps 2 – 10** for passenger side Running Board installation.
12. Do periodic inspections to the installation to make sure that all hardware is secure and tight.

To protect your investment, wax this product after installing. Regular waxing is recommended to add a protective layer over the finish. Do not use any type of polish or wax that may contain abrasives that could damage the finish.

For stainless steel: Aluminum polish may be used to polish small scratches and scuffs on the finish. Mild soap may be used also to clean the Running Board.

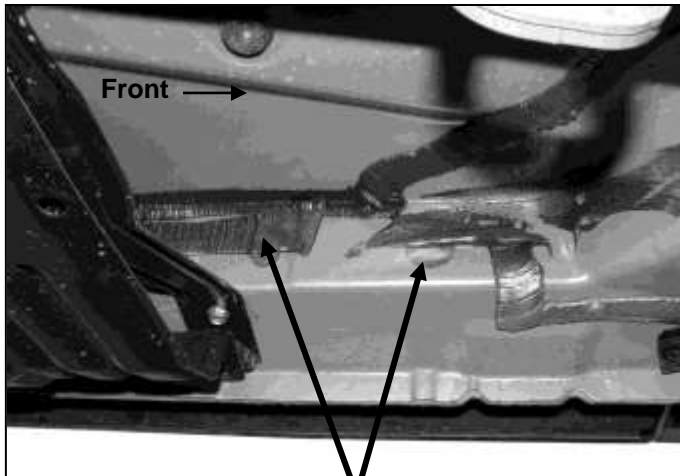

(Fig 1) Remove plastic cover. Remove rubber plugs in factory holes. **NOTE:** Driver side pictured

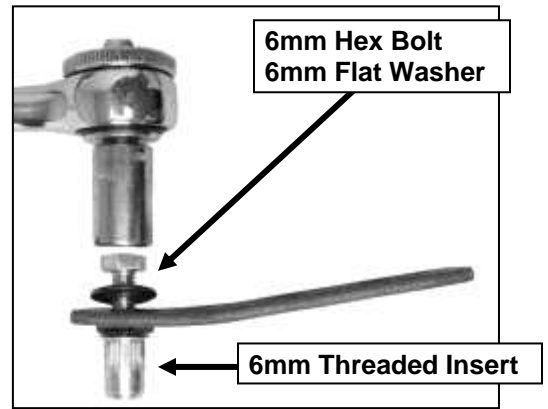

(Fig 2) 6mm Threaded Insert Tool assembly pictured

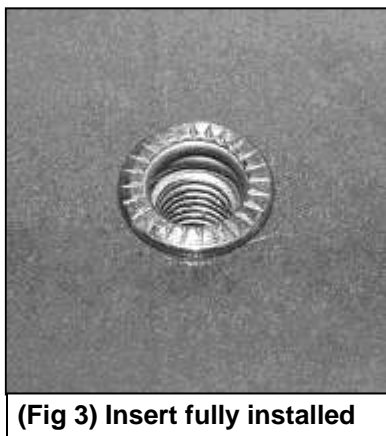

(Fig 3) Insert fully installed

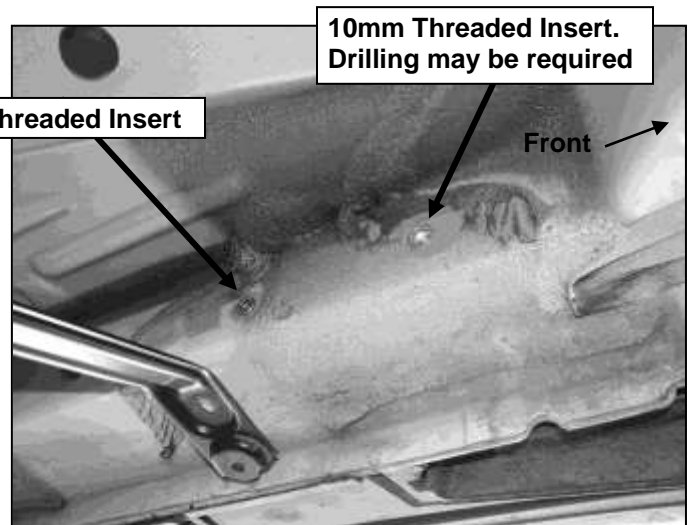

(Fig 4) Driver side front pictured

6mm Hex Bolt
6mm Lock Washer
6mm Flat Washer

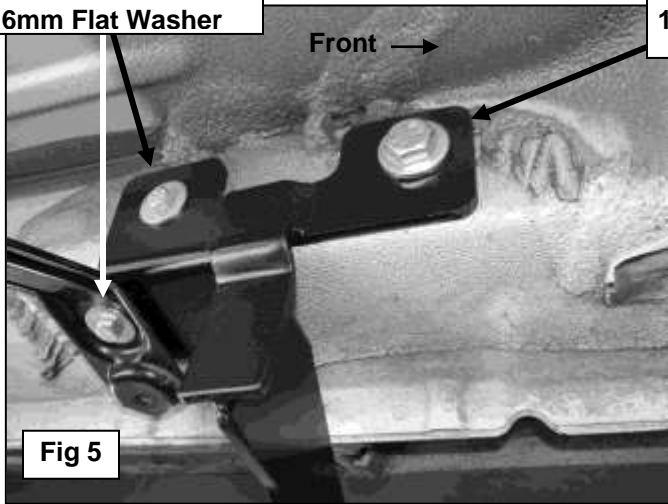
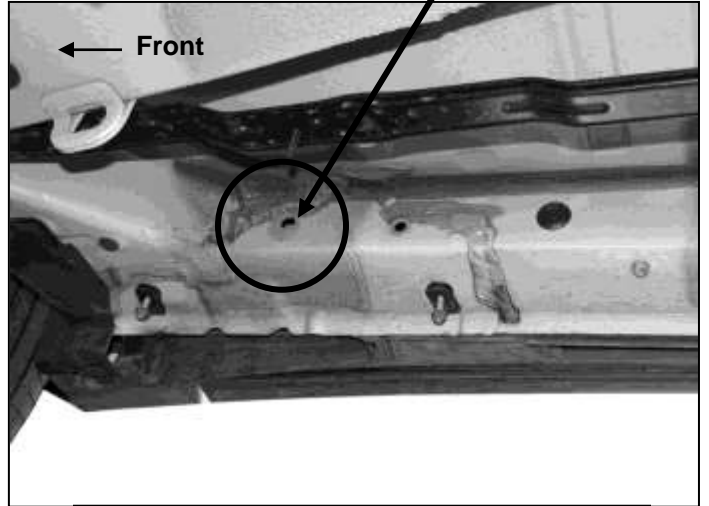

Fig 5

10mm Hex Bolt
10mm Lock Washer
10mm STD Flat Washer

NOTE: To insert a 10mm Threaded Insert into the large factory hole, check for fit and/or use 1/2" drill bit as necessary



(Fig 6) Passenger/Right side front pictured

10mm Threaded Insert.
Drilling may be required

6mm Threaded Insert

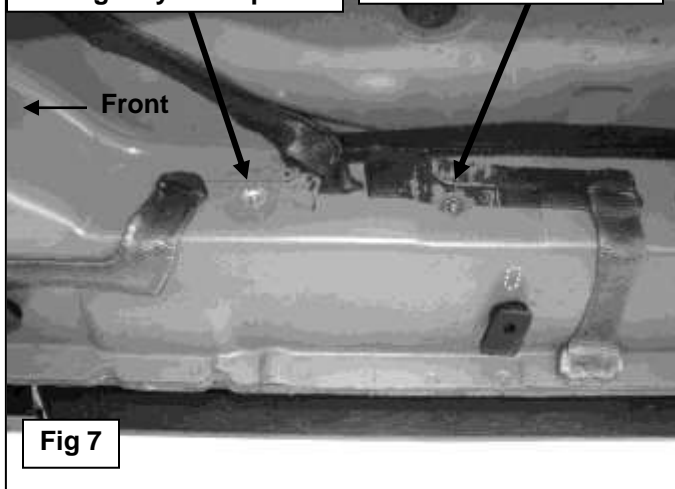

Fig 7

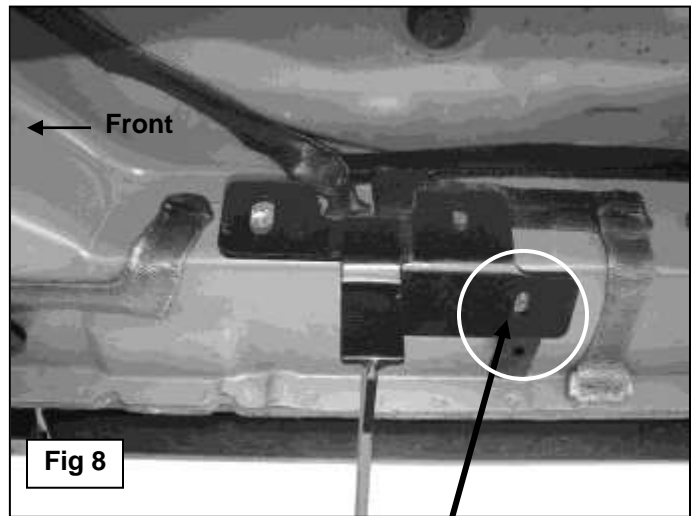
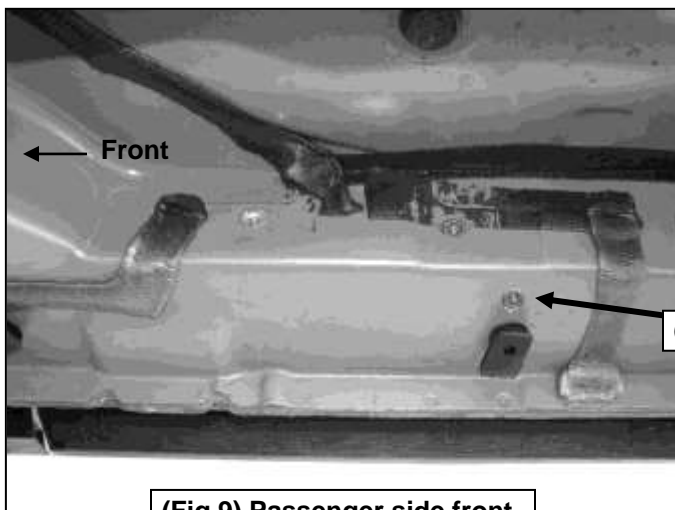

Fig 8

6mm Threaded Insert

Bolt passenger side front Bracket in place. Mark location of slot on bottom of frame channel to drill for 6mm Threaded Insert (see Fig 7)



(Fig 9) Passenger side front mounting location pictured

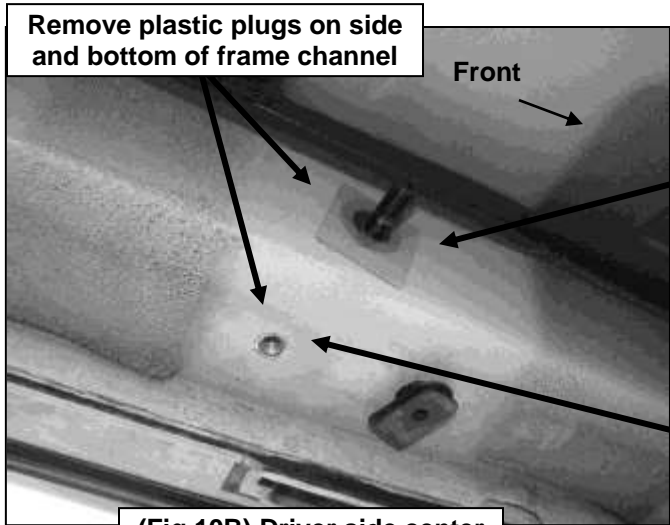

Remove plastic plugs on side and bottom of frame channel

Front



(Fig 10A) Use Plastic Retainer to hold Bolt Plate in place during Bracket installation

10mm Threaded Insert

10mm Flat Washer
10mm Flange Nut

(Fig 10B) Driver side center mounting location pictured

10mm Hex Bolt
10mm Lock Washer
10mm x 27mm STD Flat Washer

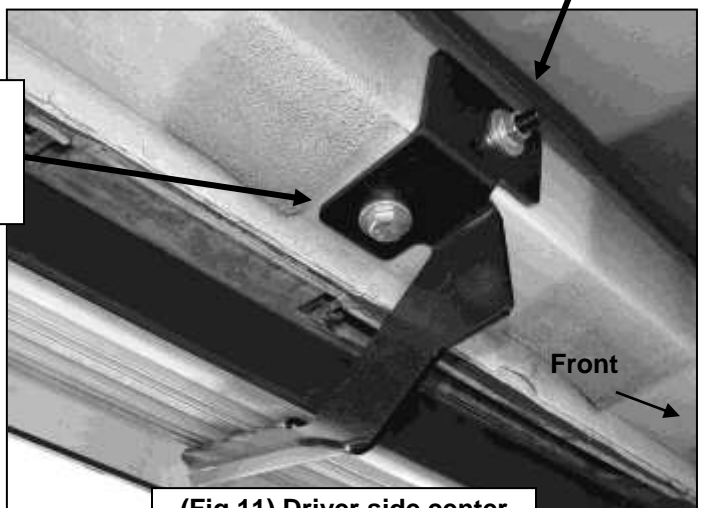

Front

(Fig 11) Driver side center Mounting Bracket pictured

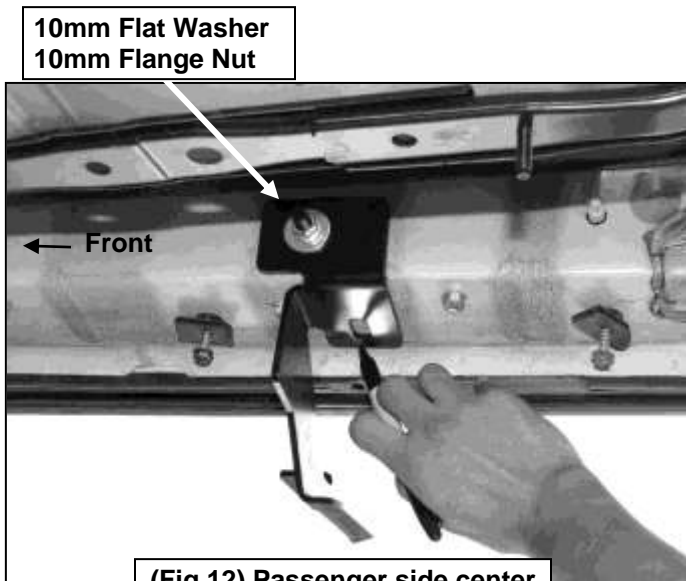

10mm Flat Washer
10mm Flange Nut

Front

(Fig 12) Passenger side center mounting location pictured

(Fig 6A) 10mm x 35mm Bolt Plate

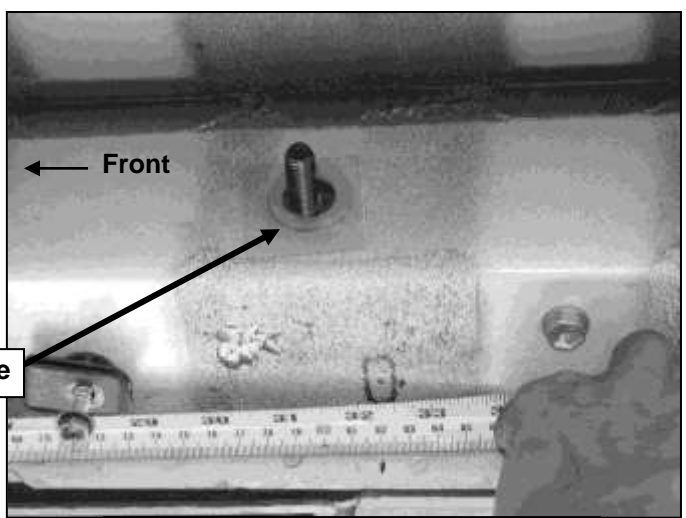

Front

(Fig 13) Passenger/Right side center Bracket mounting location pictured

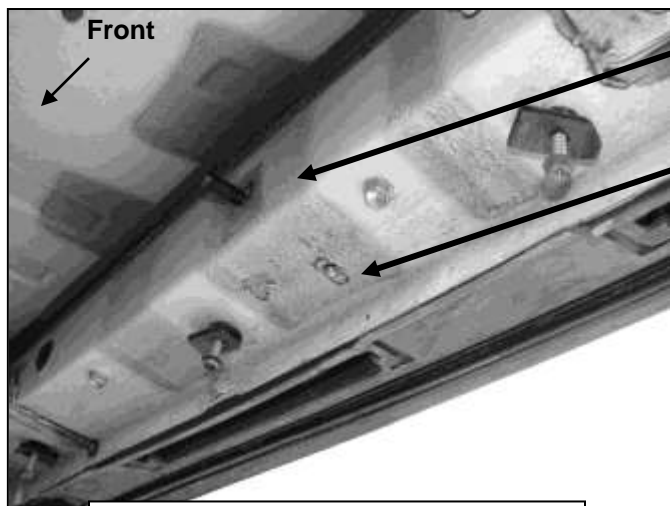

10mm Bolt Plate
10mm Plastic Retainer

10mm Threaded Insert

(Fig 14) Passenger/Right side center Bracket mounting location pictured

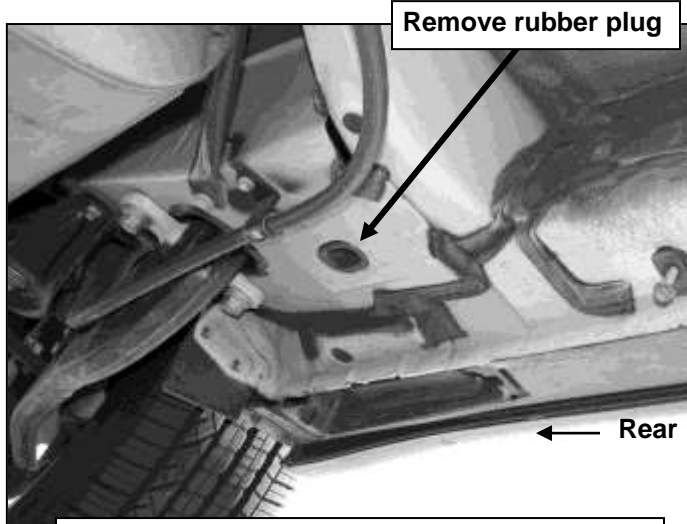

(Fig 15) Driver side rear mounting location

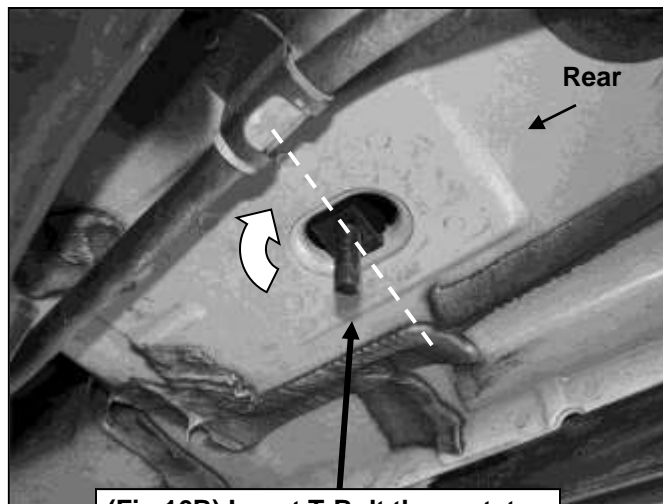

(Fig 16B) Insert T-Bolt then rotate 90-degrees to go across oval hole

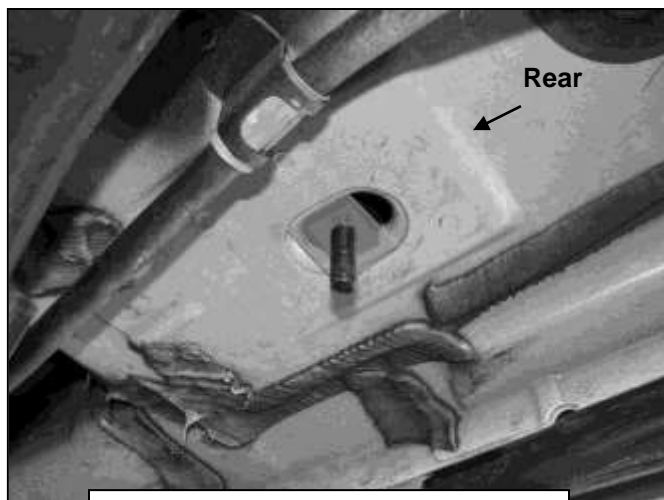

(Fig 17) T-Bolt with Plastic Retainer

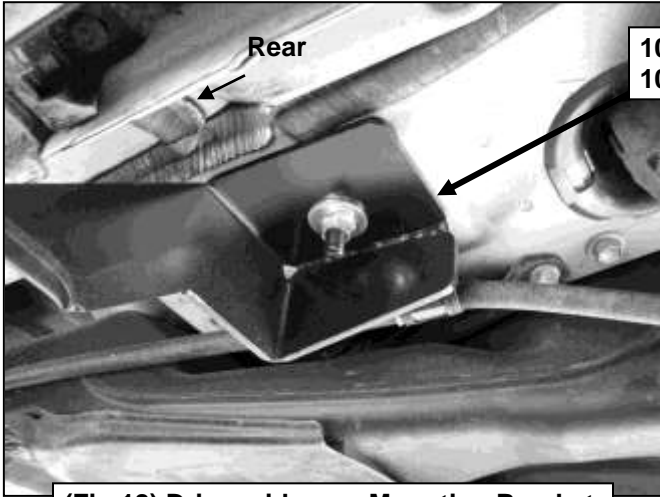

(Fig 18) Driver side rear Mounting Bracket

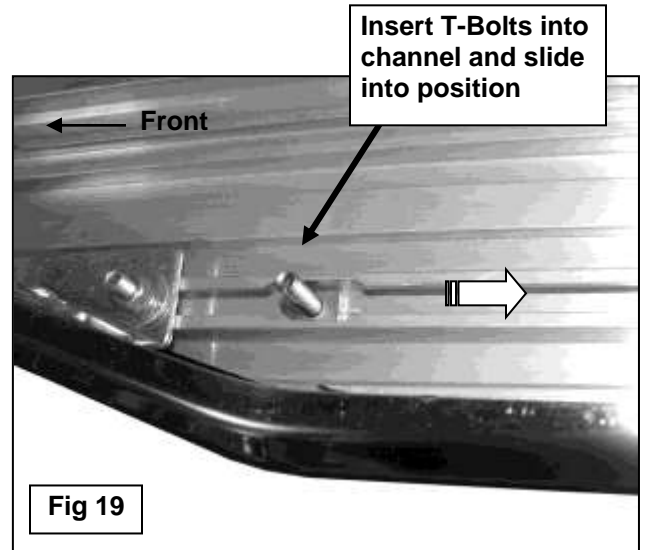

Fig 19

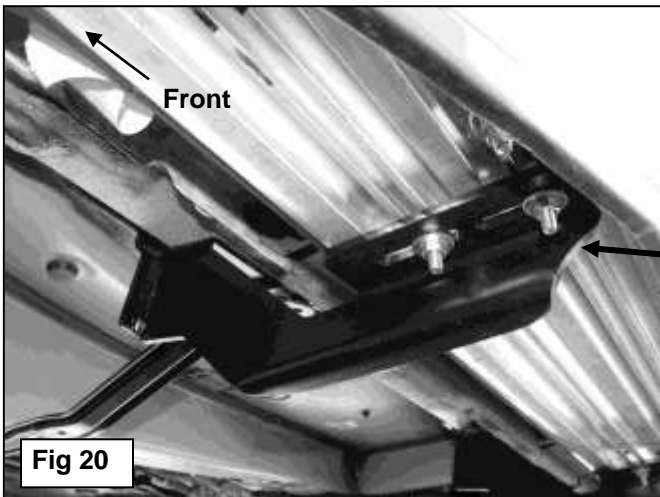
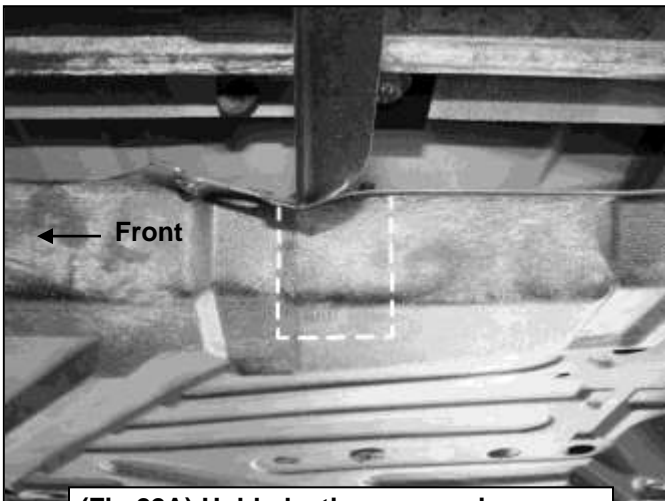

Fig 20



(Fig 21) Driver side complete installation



(Fig 22A) Hold plastic cover up in position to determine area to cut from cover. Driver side middle cover pictured



(Fig 22B) Hold plastic cover up in position to determine area to cut from cover. Driver side front cover pictured

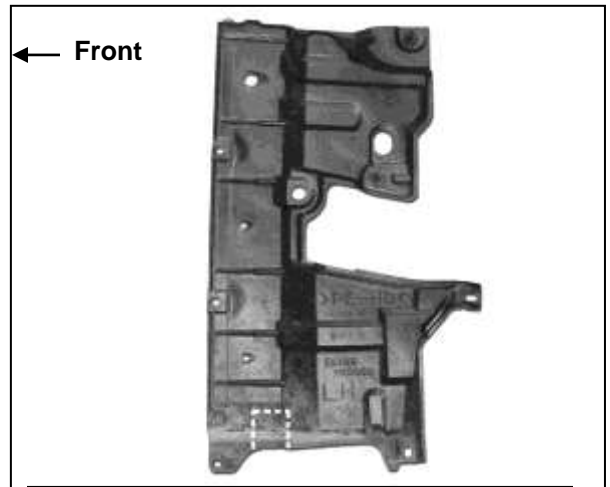

(Fig 23A) Driver side front cover pictured

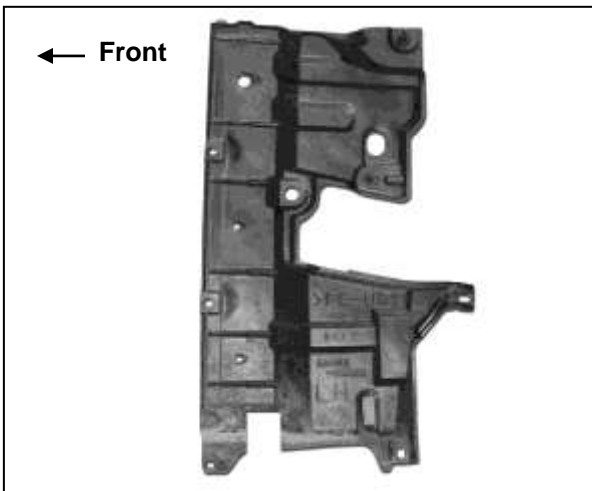

(Fig 23B) Cut cover only enough to clear Bracket. Cut shown for example only

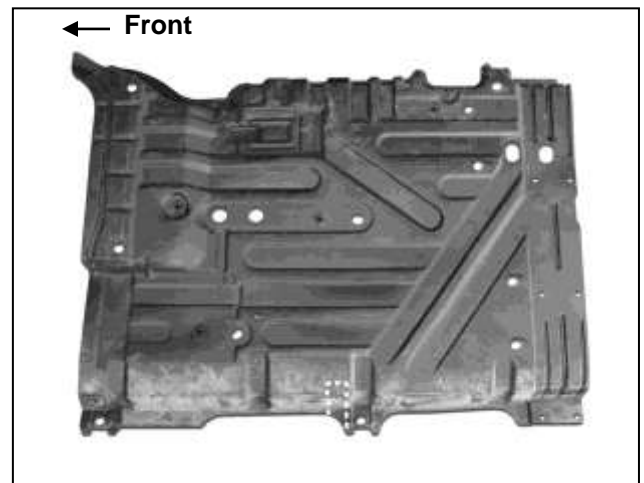

(Fig 24A) Driver side middle cover

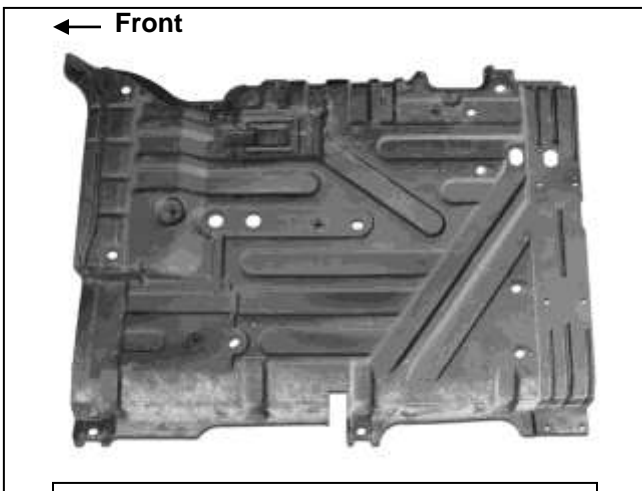

(Fig 24B) Cut cover only enough to clear Bracket. Cut shown for example only