



**BLACK HORSE
OFF ROAD®**

TEL : 1-866-XANATOS

INSTALLATION INSTRUCTIONS
ELITE RETRACTABLE POWER BOARD
19-24 DODGE RAM 1500 Crew and Quad Cab
(Incl. 19-23 TRX Models & Excl. 19-24 Ram 1500 Classic)
Patented
PART# PWBR0175 PWBR0179

INSTALLATION INSTRUCTIONS

Mechanical PARTS LIST:

Qty	Item Description	Qty	Item Description
2	Running Boards	20	M8 Nylon Lock Nuts
1	Driver/Left Front Bracket Assembly	12	Flat Washers 8mm x 24mm x 2mm
1	Passenger/Right Front Bracket Assembly	8	M6 Carriage Bolts
1	Driver/Left Rear Bracket Assembly	8	M6 Flange Nuts
1	Passenger/Right Rear Bracket Assembly	15	Zip Ties
1	Electronic Materials Package	8	M8 Carriage Bolts
1	Relocation Bracket (Left)	8	Plastic Insulators
1	Relocation Bracket (Right)		

Electronic Materials Package PARTS LIST:

Qty	Item Description	Qty	Item Description
1	Main Harness	1	ECU
2	Wire Taps	4	LED lights
1	LED Y-Harness (Short 280mm)	1	LED Y-Harness (Long 1200mm)

A

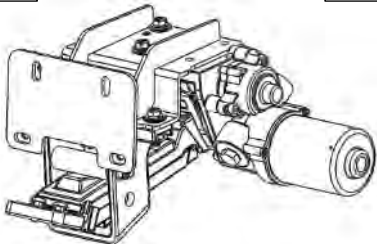

Driver Front Bracket Assembly

B

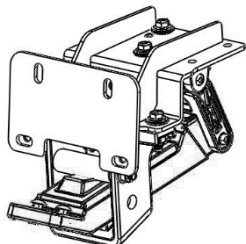

Driver Rear Bracket Assembly

C

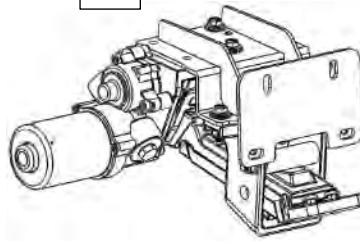

Passenger Front Bracket Assembly

D

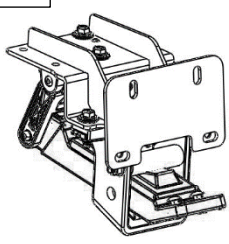

Passenger Rear Bracket Assembly

E



M6 Carriage Bolt

F

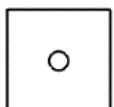

Plastic Insulator

G



M6 Flange Nut

H



Flat Washer

I

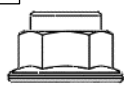

M8 Nylon Lock Nut

O



M8 Carriage Bolt

P

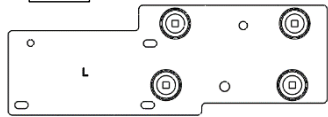

Relocation Bracket (Left)

Q

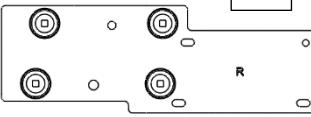

Relocation Bracket (Right)

***NOTE:** Driver and Passenger Rear Bracket Assemblies are the same.

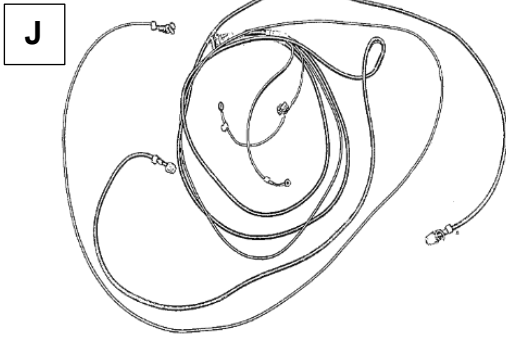

Main Harness

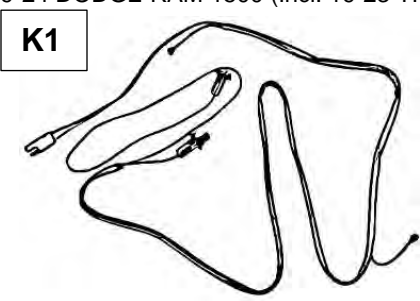

LED Y-Harness (Long)

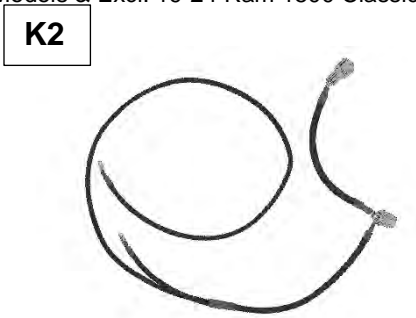

LED Y-Harness (Short)

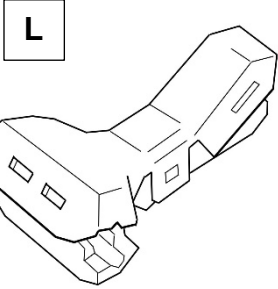

Wire Taps

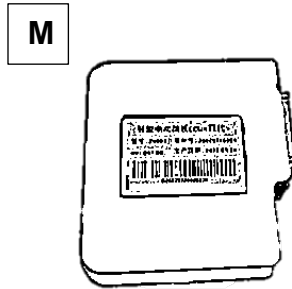



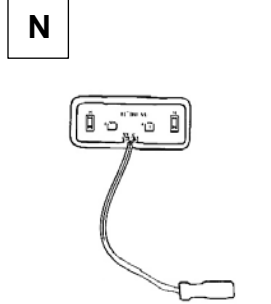

ECU



LED Lights

TOOLS REQUIRED

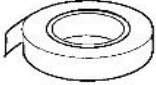
 <p>Ratchet</p>	 <p>8mm 10mm 13mm</p> <p>Socket</p>	 <p>Extensions</p>	 <p>Wrench</p>	 <p>Electrical Tape</p>
--	--	---	---	--

1A Locate body frame on underside of vehicle and identify whether there is a ATMM module. Be sure to check both Driver and Passenger Sides. Some vehicles may not have ATMM modules from the manufacturer.

If vehicle has ATMM Modules, **follow Step 1A**. If vehicle does not have ATMM modules or Mass Dampers on front part of body frame, **proceed directly to Step 1B** instead.

***WARNING:** Removing ATMM may cause excess vibration and noise when driving.



ATMM Module is meant to dampen vibrations on frame.

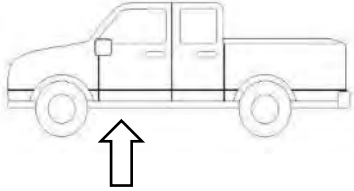

Locate Driver Side ATMM module on frame. Unplug ATMM module. Remove ATMM module from frame by unbolting fasteners.



Locate Relcation Bracket (Left) (P) and M8 Carriage bolts. Insert M8 Carriage bolts (O) through the square holes on the Relcation Bracket (P) and secure using Plastic Insulators (F). This will keep the carriage bolts from falling out of the holes on the bracket.

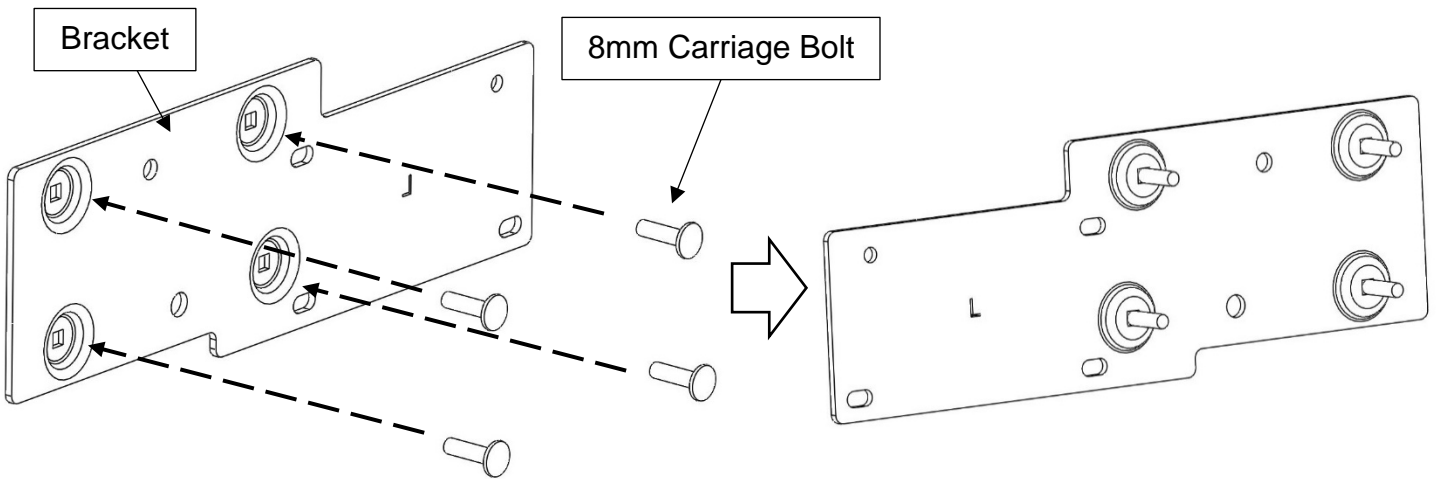

Mount the ATMM onto the relocation bracket and loosely secure into place using the provided M8 Nylon Lock Nuts (I).



Mount the Relocation Bracket (P) onto the vehicle's Driver Side frame where the ATMM was using the OE flanged bolts. Be sure to fasten all hardware fully.

The angle of cylinder housing of the ATMM can be adjusted by loosening the pivot bolt. Repeat step for Passenger Side.

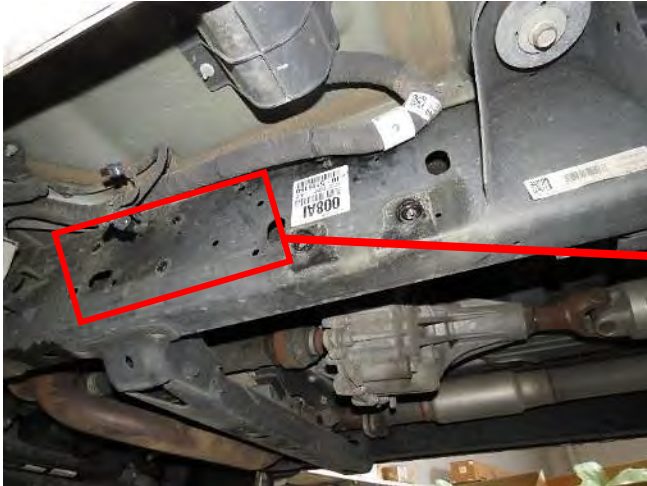

Some vehicles will have a Mass Damper instead of an ATMM. Follow the same steps and relocate the damper using the relocation brackets. Note that some vehicles will only have a mass damper on one side of the vehicle. Whenever that is the case, simply use the one appropriate relocation bracket.

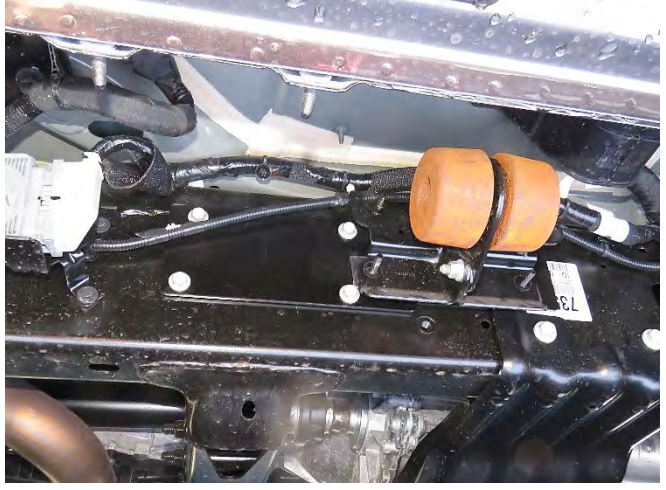
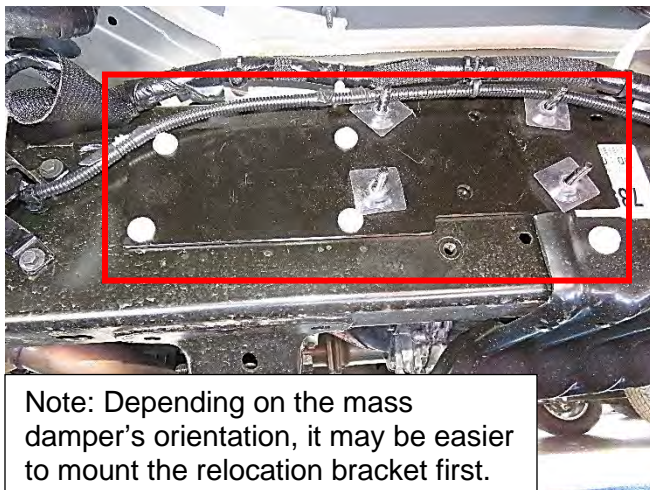
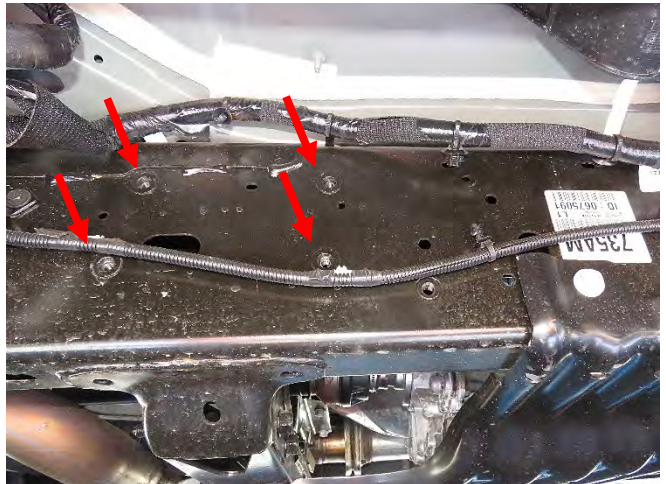
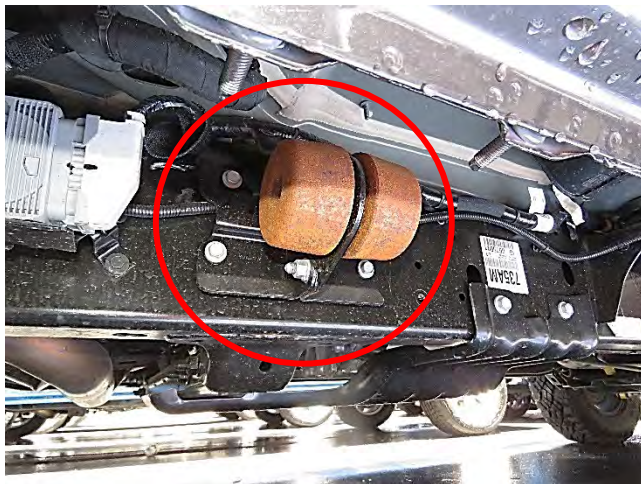

Note: Depending on the mass damper's orientation, it may be easier to mount the relocation bracket first.

On some vehicles like the TRX, an OE module plug may be in the way. If so, unbolt the plug's bracket from the frame. Then remove the plug from the bracket. Plug may be located at the front or rear.

OE plug bracket

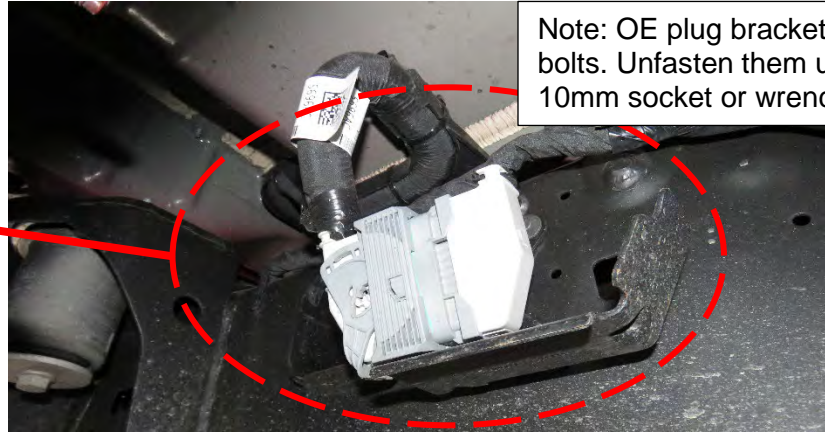

Note: OE plug bracket has 3 bolts. Unfasten them using a 10mm socket or wrench.

Once removed, resecure the plug to the frame out of the way of the components using zip ties.

1B

Next, line up front mounting bracket slots to the studs and place Driver Side/Left Front Bracket Assemble (A) onto rocker panel. Then fasten Nylon Lock Nuts (I) and washers (H). Do not tighten all the way yet. If the vehicle has Mass Dampers that are in the way, remove the mass damper before installing the bracket assembly.

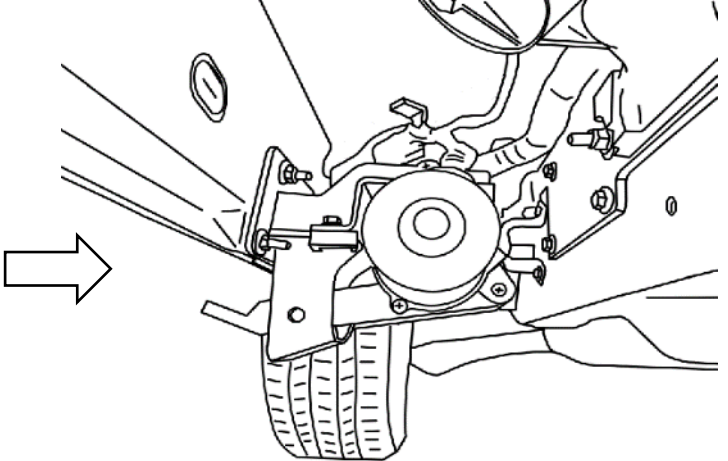
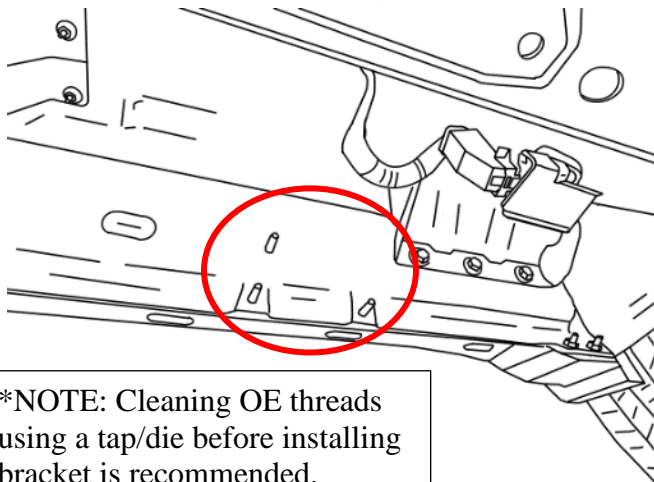

*NOTE: Cleaning OE threads using a tap/die before installing bracket is recommended.

2

Locate rear mounting points. Next, line up rear mounting bracket slots to the studs and place Driver Side/Left Rear Bracket Assembly (B) onto rocker panel. Then fasten Nylon Lock Nuts (I) and washers (H). Do not tighten all the way yet.

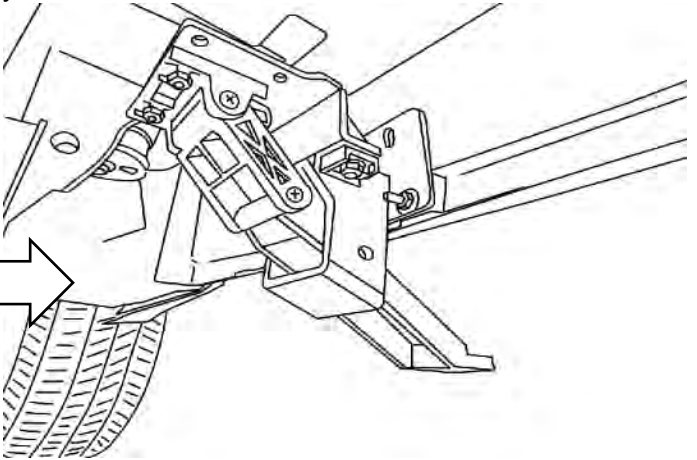
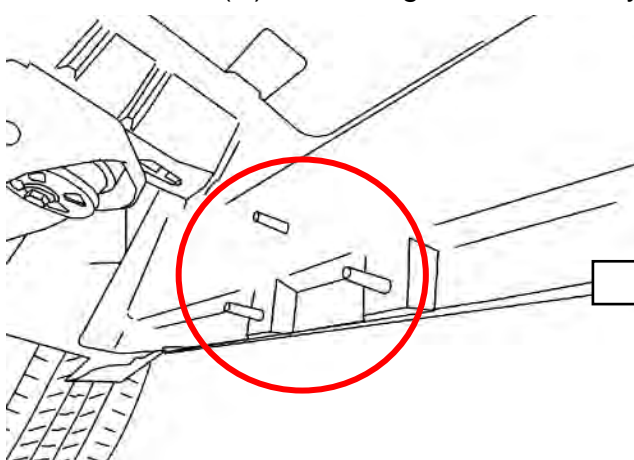

For Quad cab models, the extended rear bracket assembly (B) will shift the linkage arm position in front of the interfering vehicle frame and body mounts.

Rear Frame Body Mount

Driver Side Rear Bracket Assembly for Quad Cab

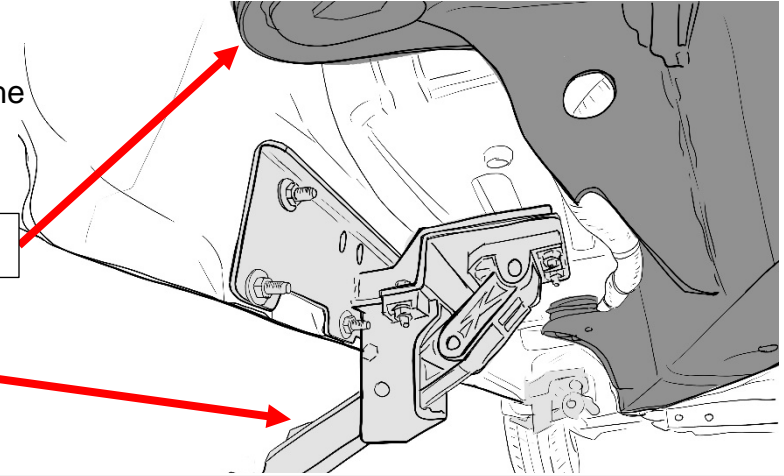

3 Repeat steps 1 – 2 for the Passenger Side.

4 Start from the engine compartment by opening the front hood of the vehicle. Locate the Battery and its terminals (positive/negative). Remove the 25A fuse from the fuse box that comes with the main harness (J).

***WARNING:** Keeping the fuse connected to the fuse box may result in electrical sparks and risk of shorting when working with the battery.

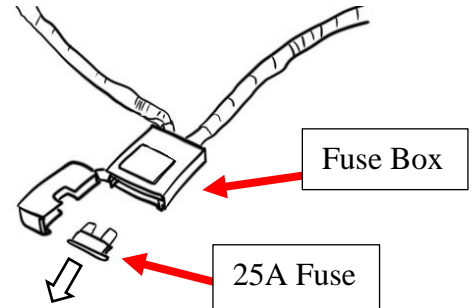
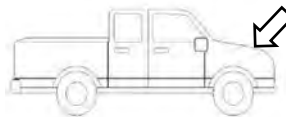

5 Connect the positive power lead on the main harness (J) to the positive battery terminal. Connect the negative lead to the negative battery terminal. Make sure both power leads are fully secured. Connect the ECU (M) to the main harness.

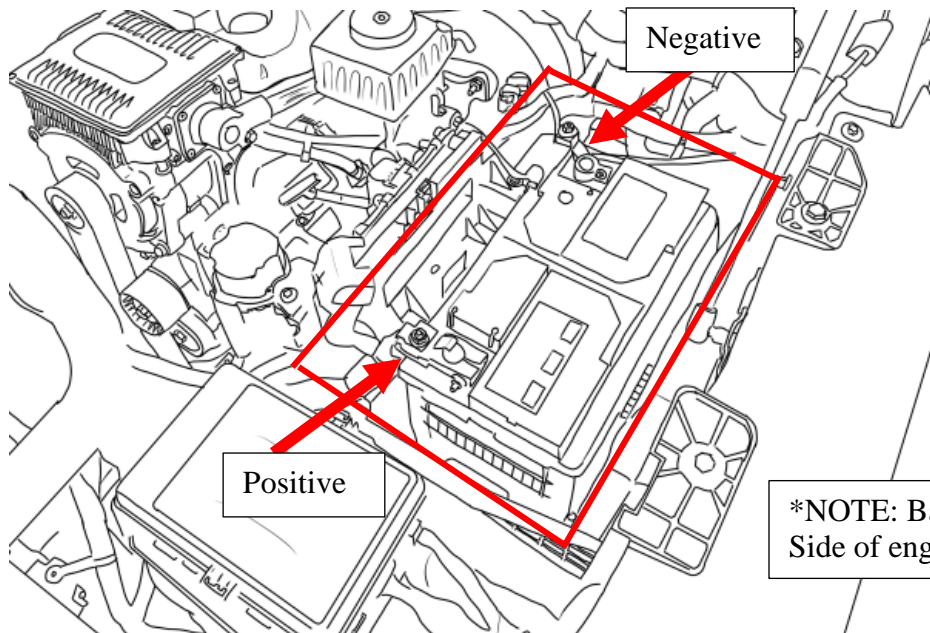

***NOTE:** Battery is on Driver Side of engine compartment.

Connect the Long LED Y-Harness (K1) to the Driver-side branch of the main harness.

Connect the Short LED Y-Harness (K2) to the Passenger-side branch of the main harness.

Connect leads before routing main harness legs in next step.

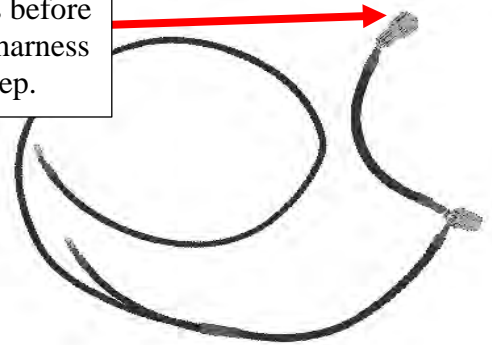

6

Route the main harness (J) around the battery, up along the rear of the engine compartment. The longer Driver-side branch of the main harness must route down the backside, against the fire wall, and down past the steering column towards the vehicle frame. **Be sure to avoid contact with the steering column.**

Route the shorter (marked "Passenger-side") leg of the harness down the Passenger-side wheel well. **Be sure to avoid contact with any moving or hot engine components.** Attach and secure the main harness (J) with supplied cable ties.

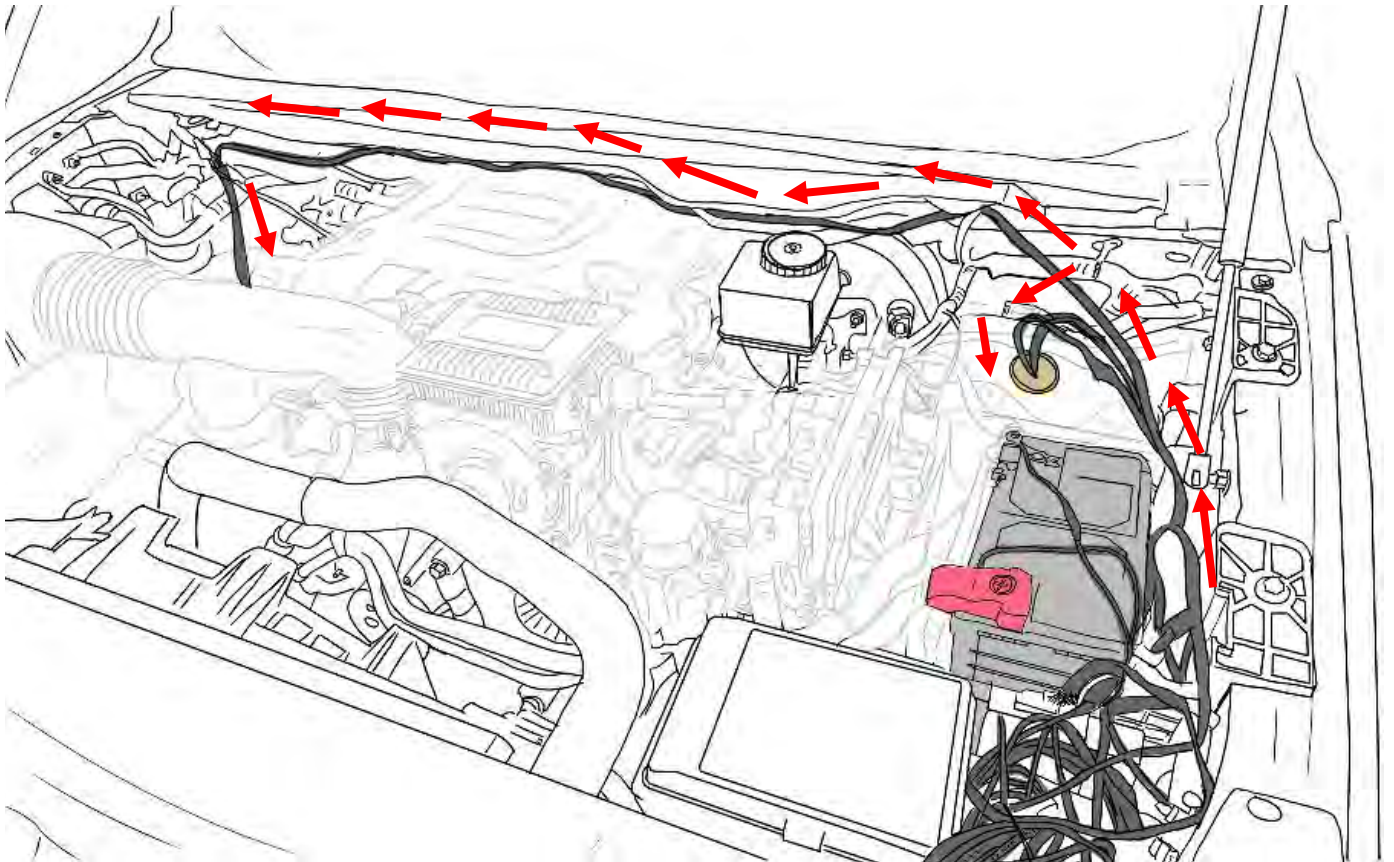

Route the CAN signal (has 2 wires with labels "High" & "Low") branch of the main harness through the double-sided rubber boot against the backside of the engine bay. The boot can be clearly seen from the inside of the cabin. **Be sure to avoid contact with the steering column.**

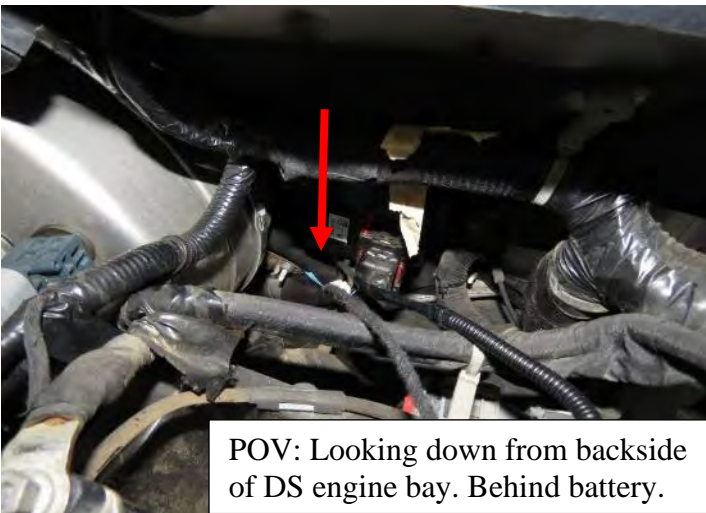
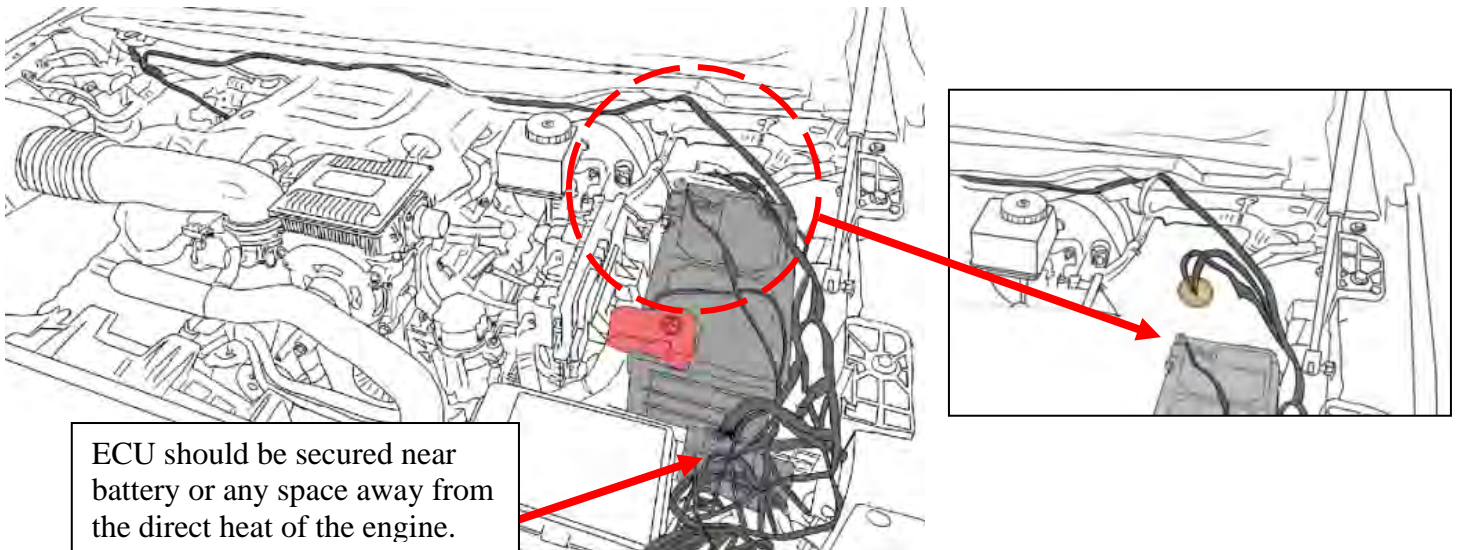

Inside the cabin, the rubber boot access is located under the steering wheel, behind the brake pedal. A pry-tool is recommended when peeling back the boot flap from the inside of the cabin.

7 Route the main harness (J) through the engine bay and **behind the Driver-Side wheel well liner**, then to the Drive-side frame.

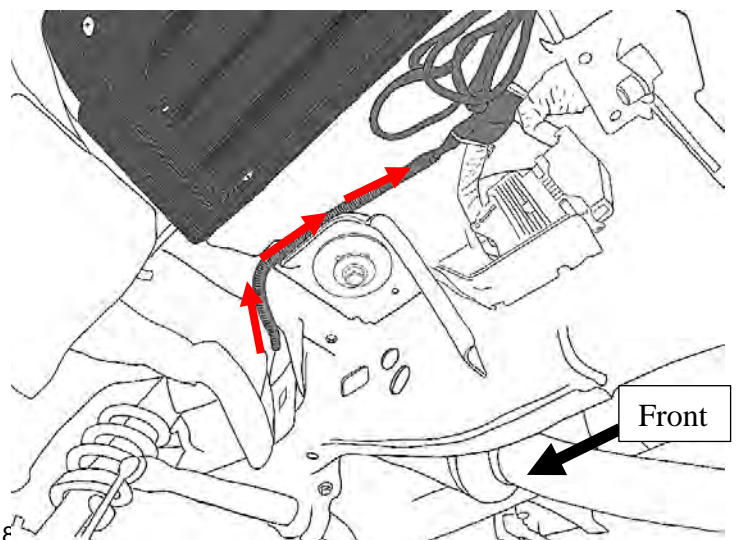
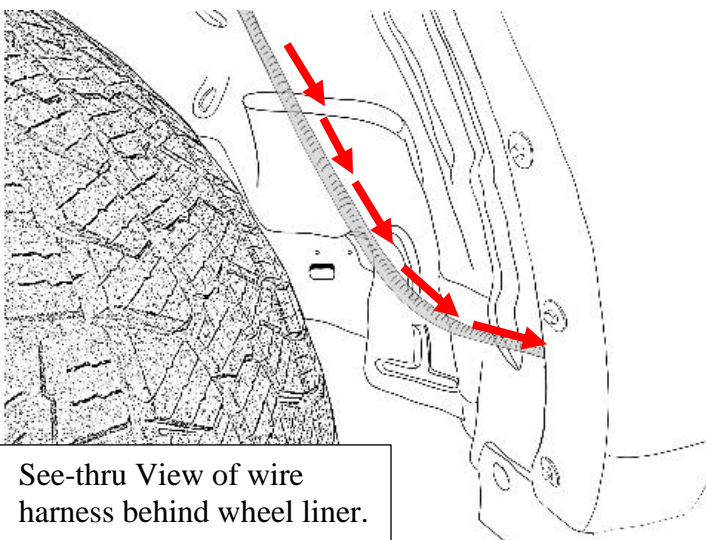

8

After routing all branches of the Main Harness (J), check to make sure the wires are secure with cable ties. **Be sure to avoid contact with any moving or hot engine components.** When routing wires through the wheel well area, **it is important to avoid the vehicle suspension.**

9

the side of the dash panel on with the front driver side door open. Carefully peel the weather strip from the door seams and use a pry tool to remove to the side dash panel.



Locate the green CAN wiring hub on the backside of the metal framework. Carefully remove the entire black plastic casing (with the green wiring hub attached) by pulling it up. On some models a plastic detent may need to be pressed to unhook the plastic casing from the metal bracket. Carefully pull the plastic hub out of the side cavity for ease of reach.

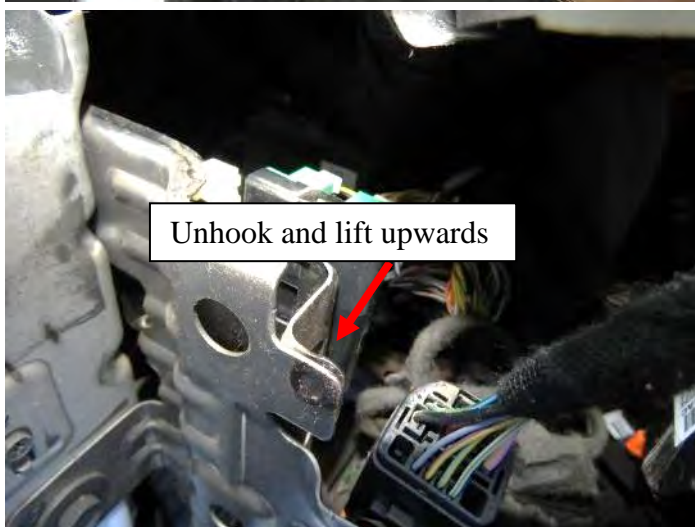
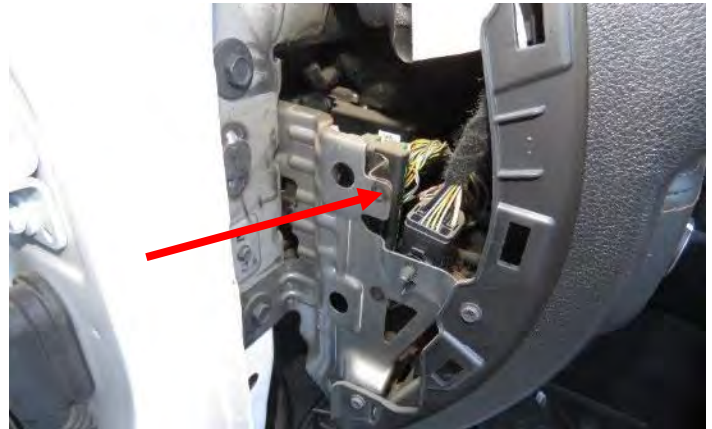

10

Identify the configuration of the plugs on the CAN Bus hub. On the row with empty slots, select the closest plug with two wires extending from it. The wire closer to the center of the hub is the CAN High wire. The wire further towards the outer edges is the CAN Low wire.

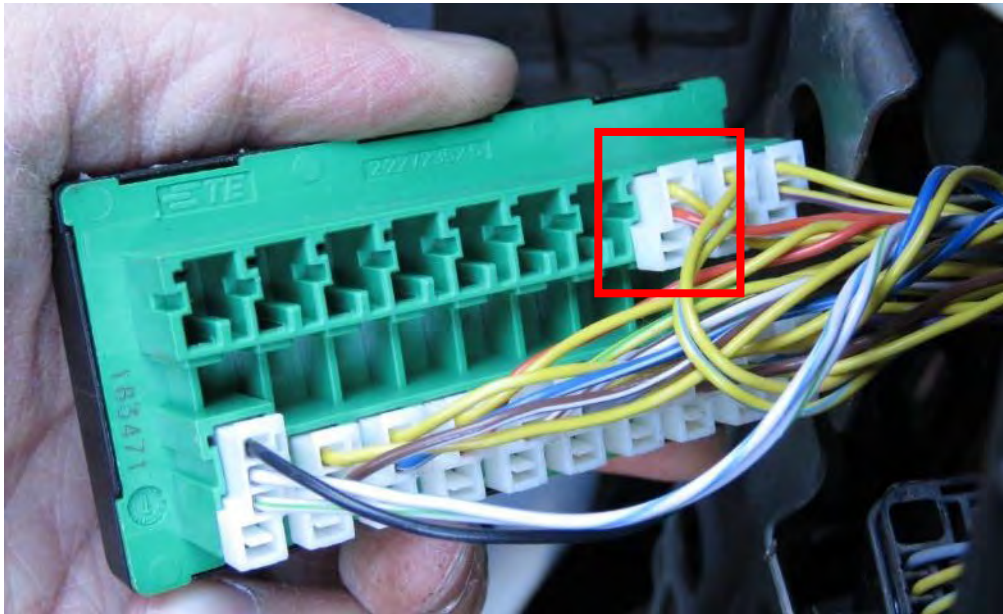

Confirm that the truck is powered off. Connect the High and Low wires from the main harness (J) using the supplied wire taps (L). After successfully connecting the wires, return the module back into its place and check that it is secure on the bracket.

*NOTE: Some colors may differ from vehicle to vehicle. It is recommended to always use the OE plug as a reference point when identifying the CAN High and CAN Low wires.

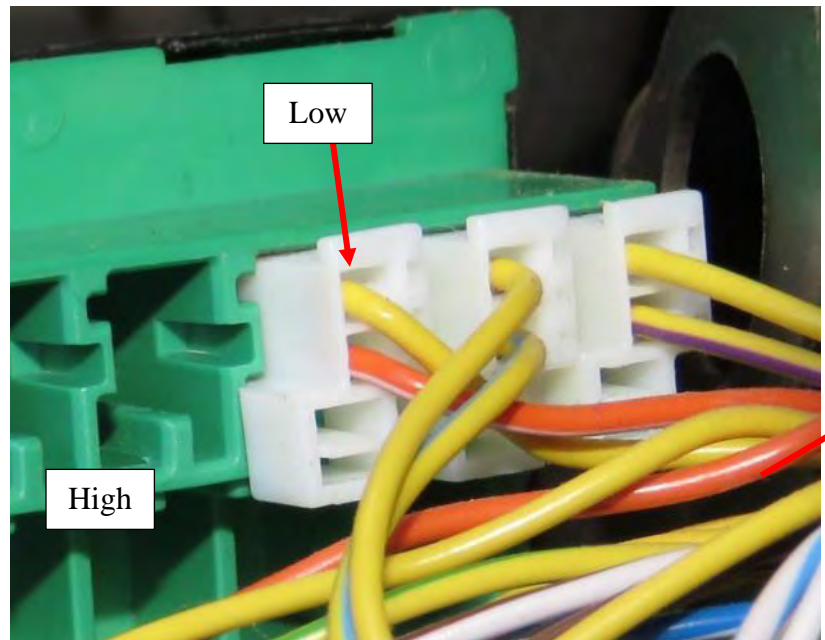

Factory CAN Wire	Main Harness wire color
Yellow (CAN-L)	Yellow (Low)
Orange w/ White Stripe (CAN-H)	White (High)

*NOTE: Vehicles will often have different colored wires on the plugs. If the indicated wire colors are not present, tap any of the pairs of wires on the upper row.

Wire taps supplied with kit. Please see next page for guide.

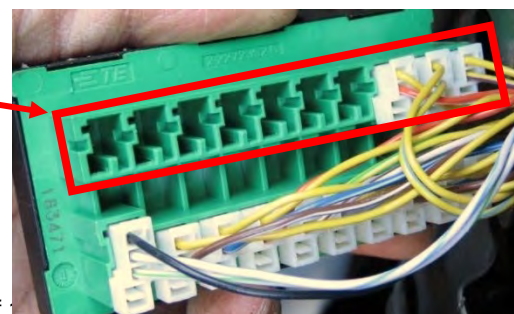

The kit comes supplied with wire taps called “shark taps”. Follow the guide below to tap the wire using the “shark tap”:

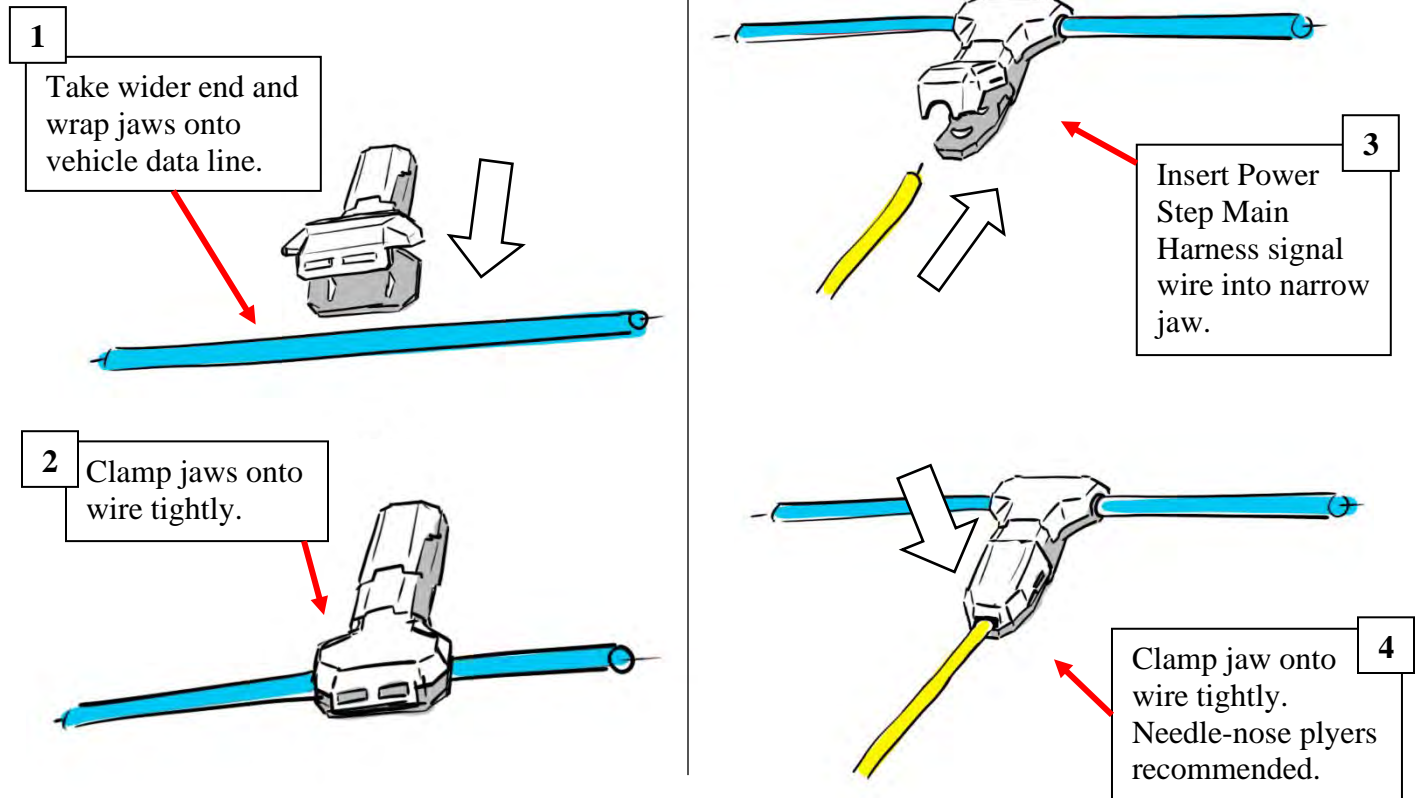

NOTE: Make sure wire is seated properly in the jaws before clamping. The wire being tapped must be centered on the “teeth” to make a proper tap.

11 Be sure the main harness (J) is connected to the appropriate length LED Y-Harness (K). Then attach the LED Y-Harness (K) to the motor on the Driver Side. Repeat for Passenger Side.

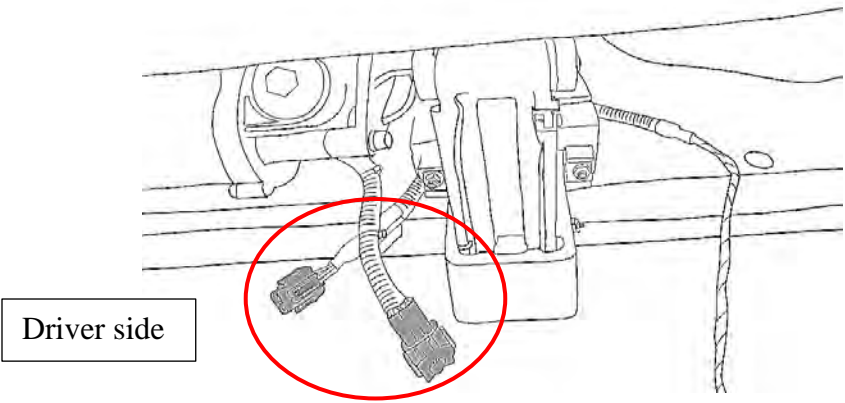

- 12** Plug in LED lights (N) into LED Y-Harness (K) and attach them to the bottom of the rocker panel. Use provided 3M double sided adhesive tape on back of LED light (N). Replace Fuse into Fuse Box.

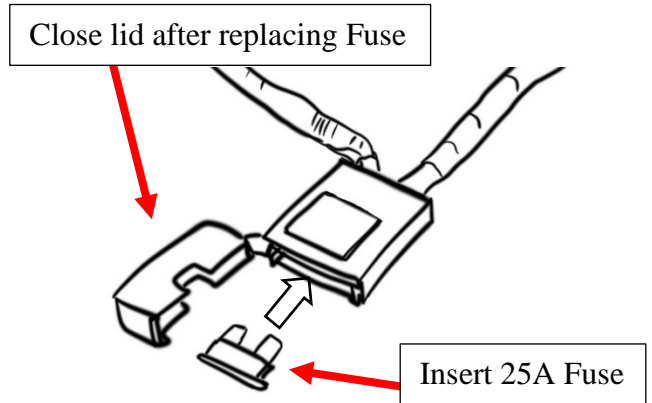
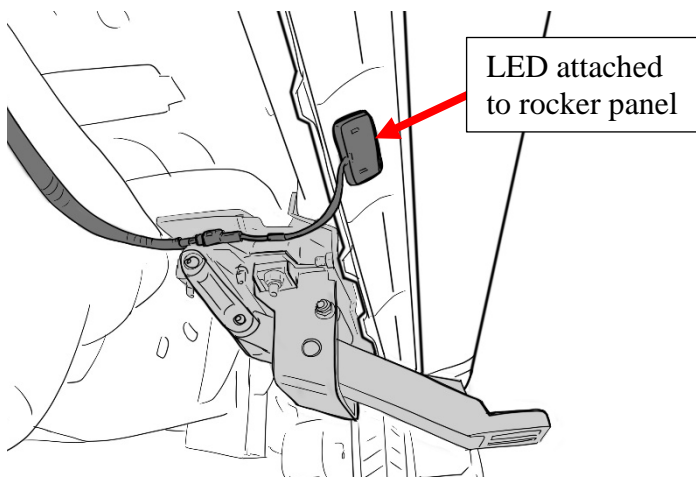

- 13** Check to make sure the harnesses on the Driver Side/Left Front Bracket Assembly (A) and Passenger Side Front Bracket Assembly (C) are connected to the main harness (J) via the LED-Y harnesses (K).

*NOTE: The linkage arms on the front bracket assemblies will not move unless both motors are connected.

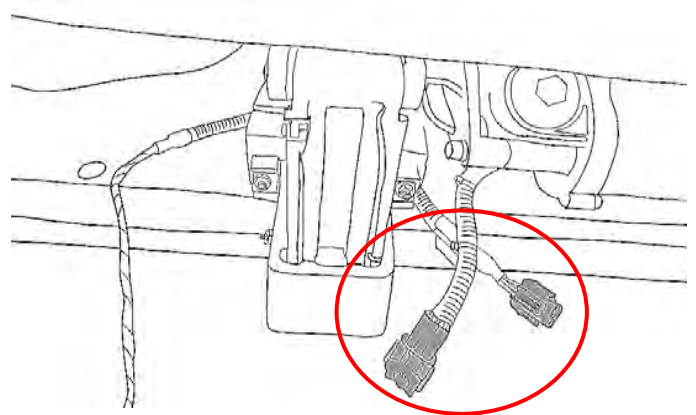

- 14** Seal the rubber boot with RTV Silicone Sealant if needed.

Hide wires and reattach the interior panels with the carpet fully unfurled in its original position. Reattach the door sill weather strip.

Check to make sure there are no obstructions or potential snag points around the brake pedal area.

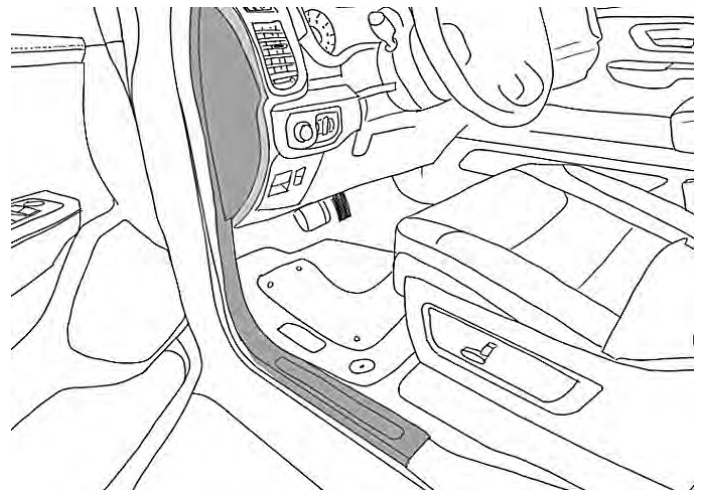

16

Prepare the power step boards. Locate the end of the boards and slide the M6 Carriage Bolts (E) into the channel on the underside of the board. Insert a total of 4 carriage bolts (E).

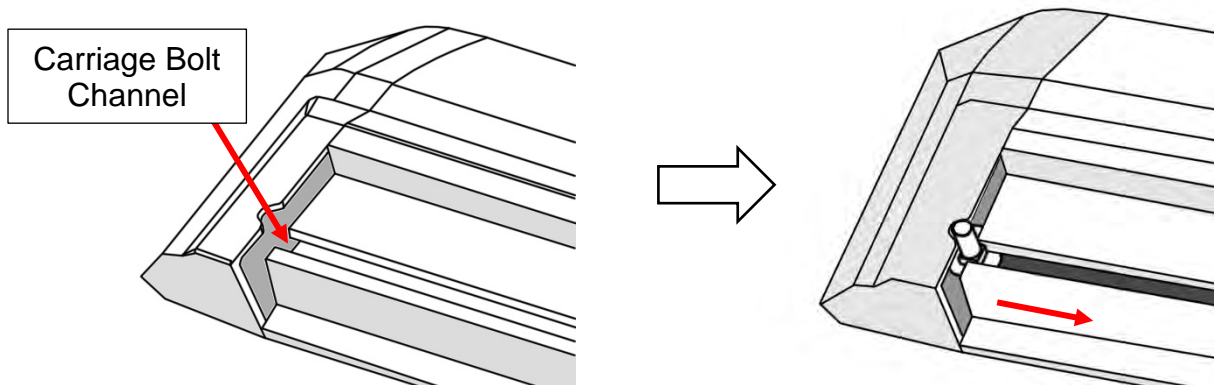

Use the notch in the board's end caps to feed the bolts into the channel.

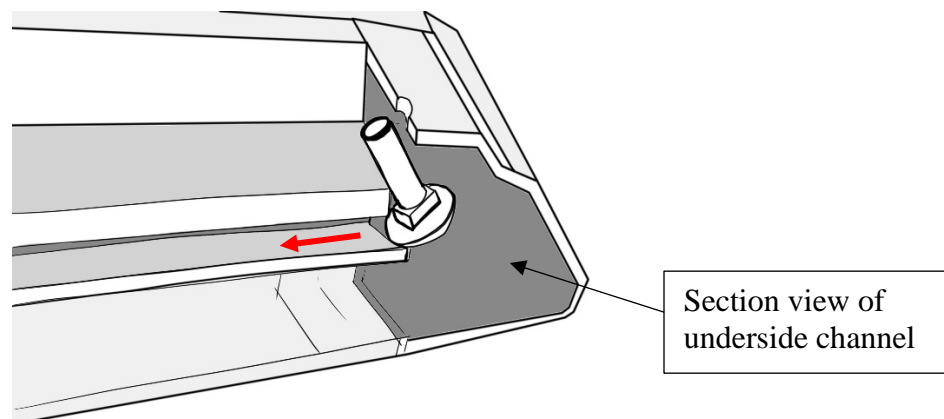
**17**

Perform a function check by closing the driver side front door and opening it again. The front bracket assembly (A) motor should activate the linkage arm and move it into the down or "deployed" position.

After deploying linkage arms, unplug main harness connector while front door is open to hold the board in the deployed position for running board installation.

Line up the carriage bolts (E), under the power step boards, with the slots on the linkage arms (A & B). Insert the 4 carriage bolts (E) into the slots on front and rear linkage arms. Adjust board to desired position. Moderately hand tighten the flange nuts (G) onto the carriage bolts.

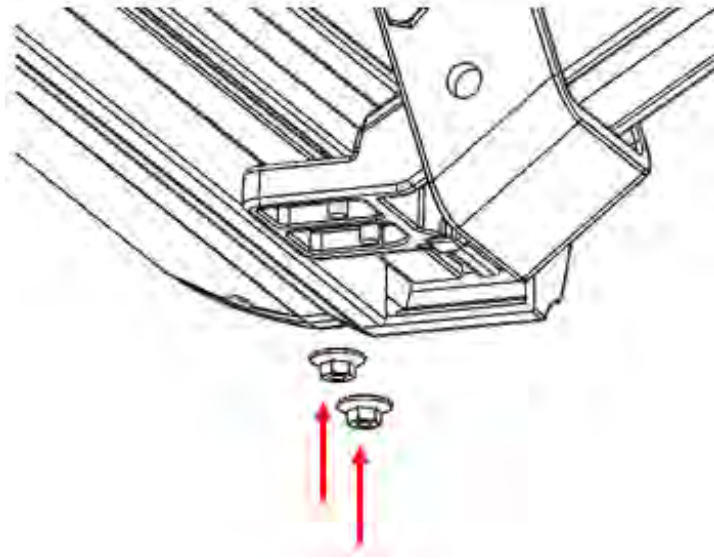

Once the board is adjusted, plug in main harness (J) connector to return power to the linkage arms. Open and close doors several times to deploy and retract the steps to settle the steps into their natural alignment. After cycling the step, tighten all hardware on the board and brackets.

Some further adjustment may be required for desired step position. Repeat for passenger side.

18 Perform system check and troubleshooting. If board is making irregular movements or noise, readjust the boards as follows:

- a) With board deployed loosen 6mm flange nuts under board.
- b) Leave the flange nuts slightly less than snug.
- c) Open and close door several times for board to settle into position.
- d) With the step in the deployed position, gradually tighten flange nuts while alternating between each. Do not over tighten.

If board is making abnormal noise or the motion is binding, repeat steps “a” through “d”.

Note: If the above method does not resolve the issue, the brackets mounting to the vehicle may not be aligned properly with the vehicle. In this case, remove the board and realign brackets before attempting steps “a” to “d” once again.

Reinstall any remaining trim panels if necessary. Check and make sure all hardware is fully tightened. Perform a final system check. Finish.

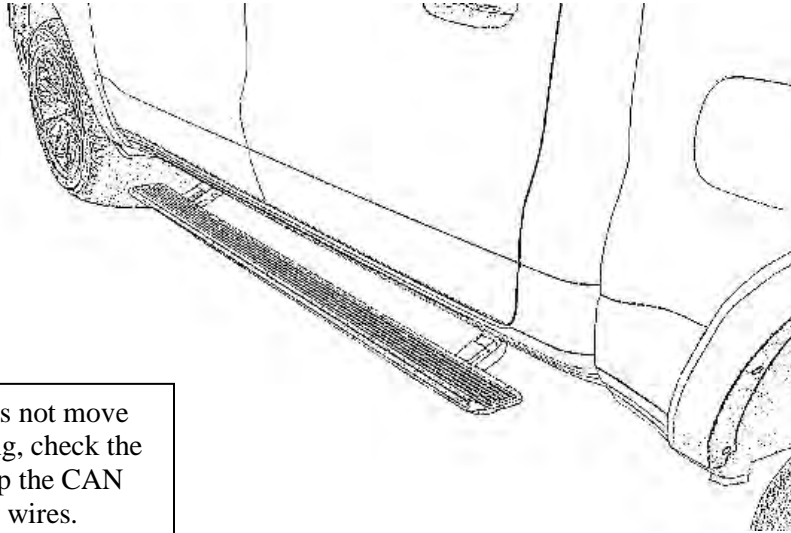

*NOTE: If board does not move during troubleshooting, check the tap connections or flip the CAN Signal High and Low wires.