



**BLACK HORSE  
OFF ROAD®**

**TEL : 1-866-XANATOS**

## **INSTALLATION INSTRUCTIONS**

**ELITE RETRACTABLE POWER BOARD**

**2021+ FORD BRONCO 4 DOOR**

**(Incl. Raptor and Heritage Model)**

**PART# PWBR2271**

**US PATENTED**

## INSTALLATION INSTRUCTIONS

### Mechanical PARTS LIST:

Qty	Item Description	Qty	Item Description
2	Power Step Boards (71in)	8	6-1.00mm x 25mm Hex Bolt
1	Driver/left Front Bracket Assembly	16	6mm x 18mm x 1.6mm Flat Washer
1	Passenger/right Front Bracket Assembly	8	6mm Flanged Nylon Lock Nuts
1	Driver/left Rear Bracket Assembly	8	6mm Flange Nuts
1	Passenger/right Rear Bracket Assembly	8	6-1.00mm x 20mm Carriage Bolts
4	10-1.50mm x 30mm Hex Bolt	1	Electronic Materials Package
4	10mm x 30mm x 2.5mm Flat Washer	15	Zip tie
4	10mm Lock Washer		

### Electronic Materials Package PARTS LIST:

Qty	Item Description	Qty	Item Description
1	Main Harness	1	ECU
2	Wire Taps	4	LED lights
1	LED Y-Harness (Short 280mm)	1	LED Y-Harness (Long 1200mm)

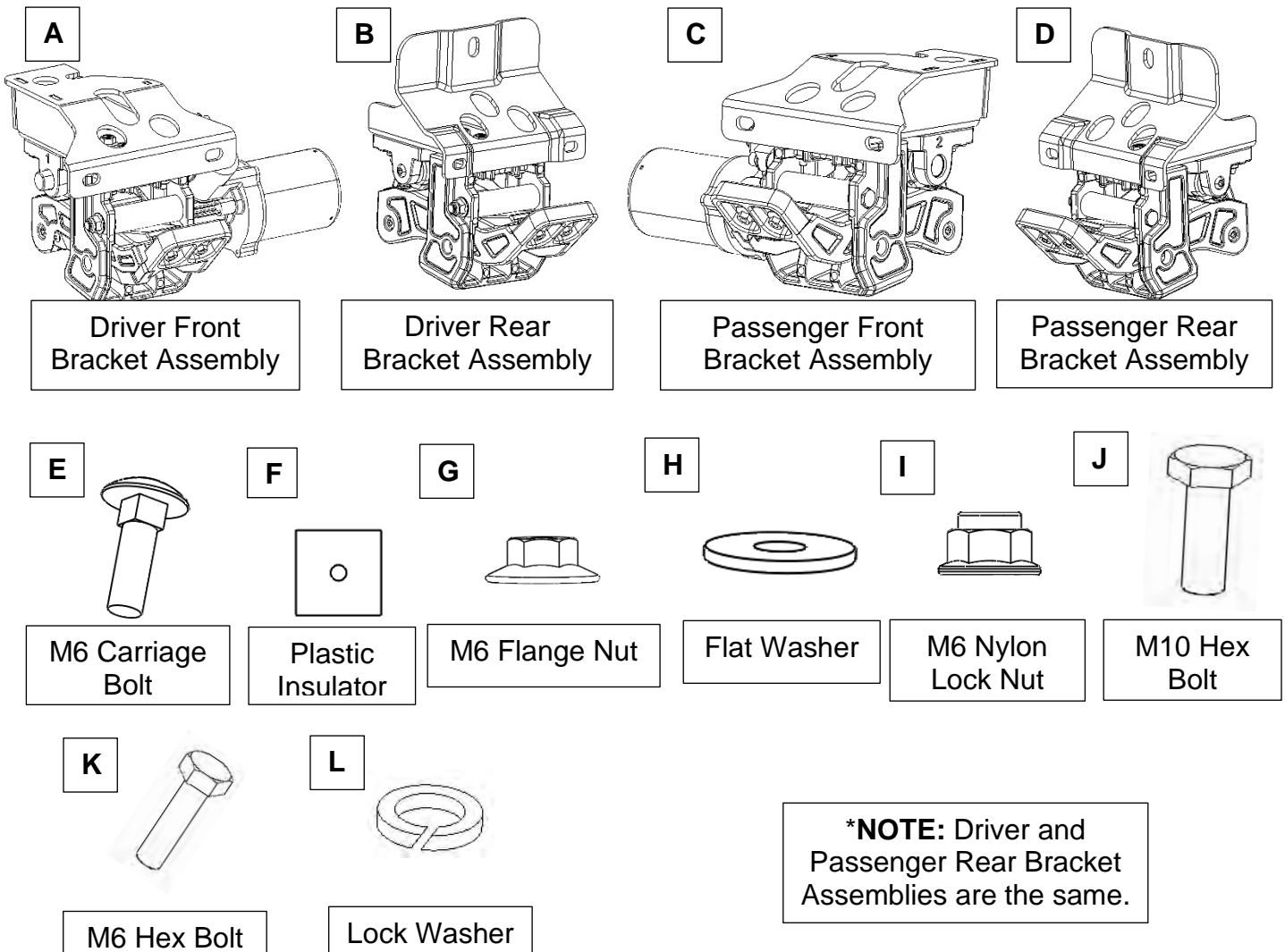

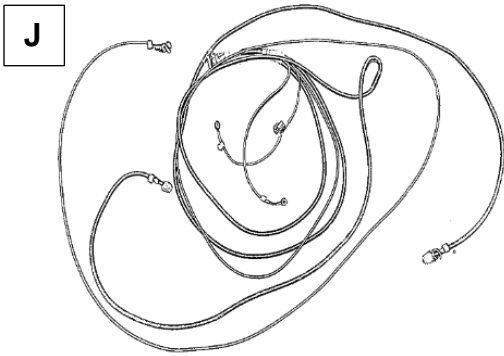

Main Harness

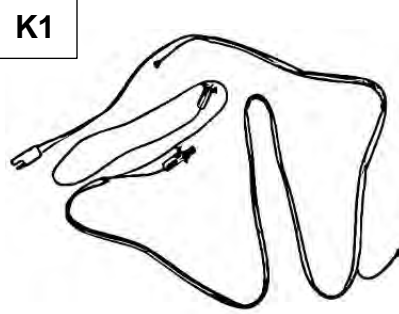

LED Y-Harness (Long)

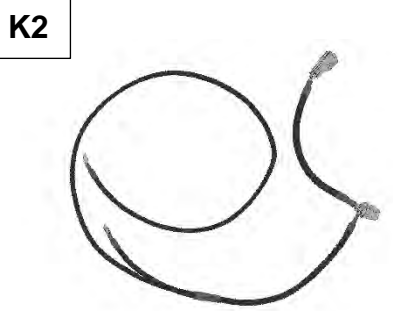

LED Y-Harness (Short)

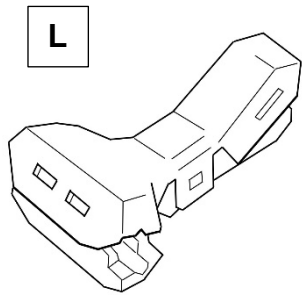

Wire Taps

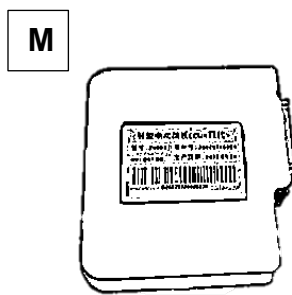

ECU

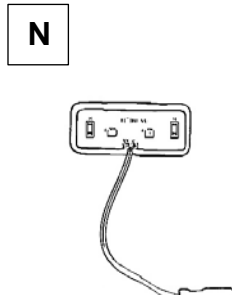

LED Lights

**TOOLS REQUIRED**



Ratchet



8mm  
10mm  
13mm

Socket



Extensions



Wrench

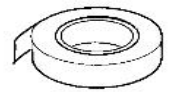

Electrical Tape

**1**

Locate the Driver Side front mounting points on the rocker panel under the front door. Loosely screw in the M10 Hex Bolt (J) and correct Washers into the upper threaded insert. Do **not** screw in all the way yet. The bracket will slide into the bolt and will be tightened later.

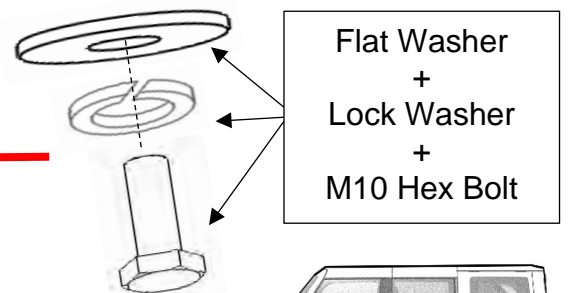

Flat Washer  
+  
Lock Washer  
+  
M10 Hex Bolt

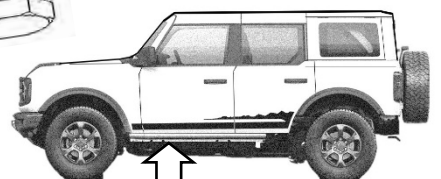

**2**

Next, line up front mounting bracket slots to the holes on the pinch weld and the M10 Hex Bolt (J), and then place Driver Side/Left Front Bracket Assembly (A) onto rocker panel. Then fasten the M6 Bolts (K), Nylon Lock Nuts (I), washers (H), and the M10 Bolt (J). Do not tighten all the way yet.

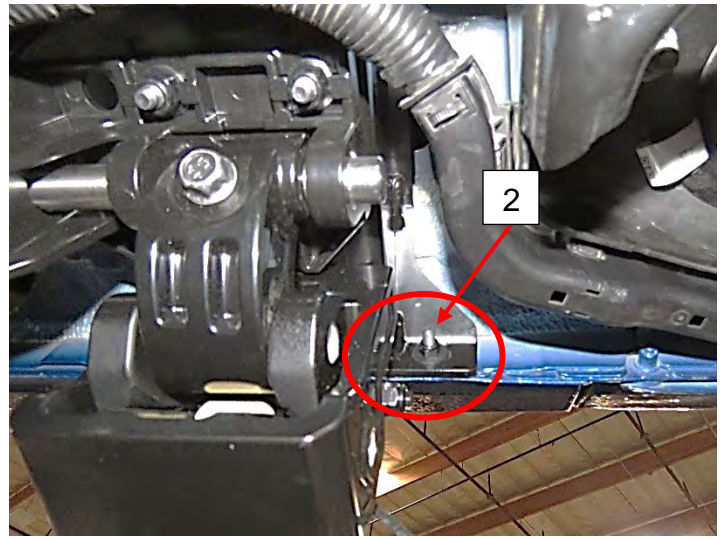
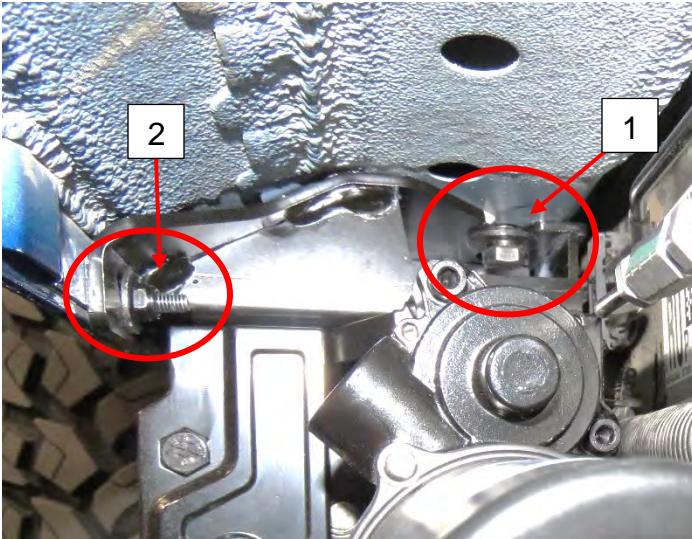
**3**

Locate rear mounting points. Next, line up rear mounting bracket slots to the top threaded insert and holes on the pinch weld, and then place the Driver Side/Left Rear Bracket Assembly (B) onto rocker panel.



Then fasten the Bolts (J & K), Nylon Lock Nuts (I) and Washers (H). Do not tighten all the way yet. For some vehicles it may be necessary to push or unhook the OE wiring harnesses and re-tie them out of the way using zip ties.

**NOTE:** Passenger Side typically has an exposed OE wire connector that needs to be relocated using zip ties.

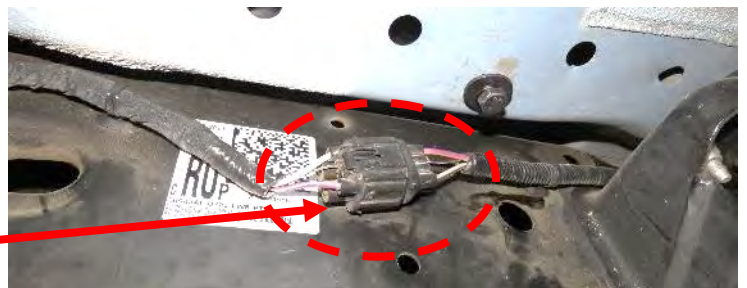

4

Repeat steps 1 – 3 for the Passenger Side.

5

Start from the engine compartment by opening the front hood of the vehicle. Locate the Battery and its terminals (positive/negative). Remove the 25A fuse from the fuse box that comes with the main harness (J).

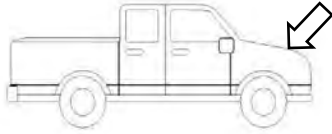

**\*WARNING:** Keeping the fuse connected to the fuse box may result in electrical sparks and risk of shorting when working with the battery.

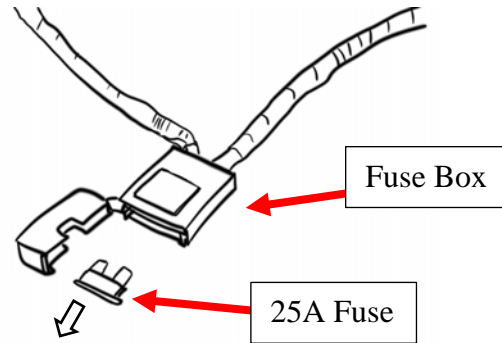

6

Connect the positive power lead on the main harness (J) to the positive battery terminal. Connect the negative lead to the negative battery terminal. Make sure both power leads are fully secured. Connect the ECU (M) to the main harness. Connect the Long LED Y-Harness (K1) to the Passenger-side branch of the main harness. Connect the Short LED Y-Harness (K2) to the Driver-side branch of the main harness.

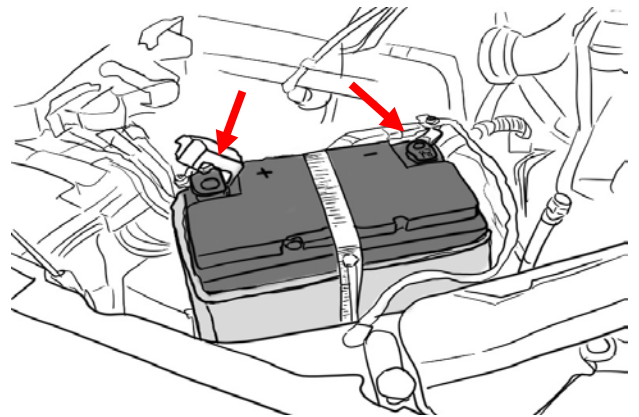

7

Route the main harness (J) around the battery, up along the rear of the engine compartment, and down the Driver-side wheel well. Route the shorter leg of the harness down the Passenger-side wheel well. **Be sure to avoid contact with any moving or hot engine components.** Attach and secure the main harness (J) with supplied cable ties.

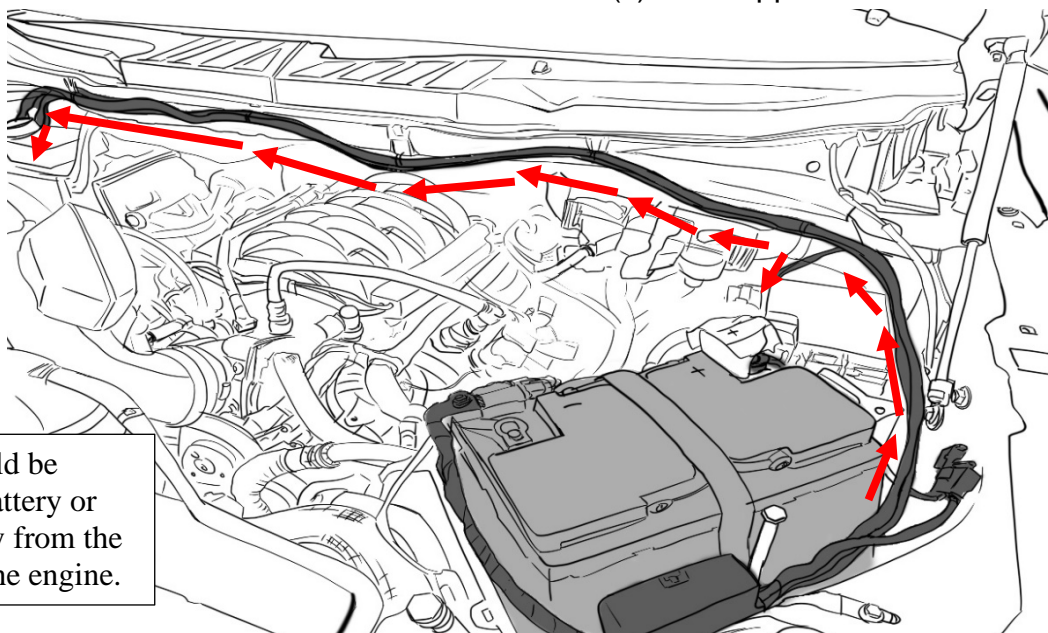

ECU (M) should be secured near battery or any space away from the direct heat of the engine.

On the underside of the driver side, locate and remove the floor grommet in the floor panel behind the front wheel well. The grommet will be close to the front linkage arm. Poke a hole through the grommet and thread the two signal wires through and up into the vehicle cabin.

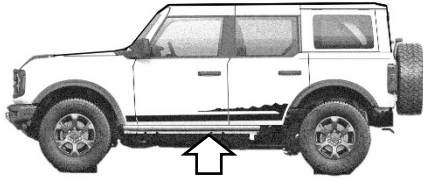

Carefully put wiring through rubber floor plug

POV: Underside of vehicle, near front.

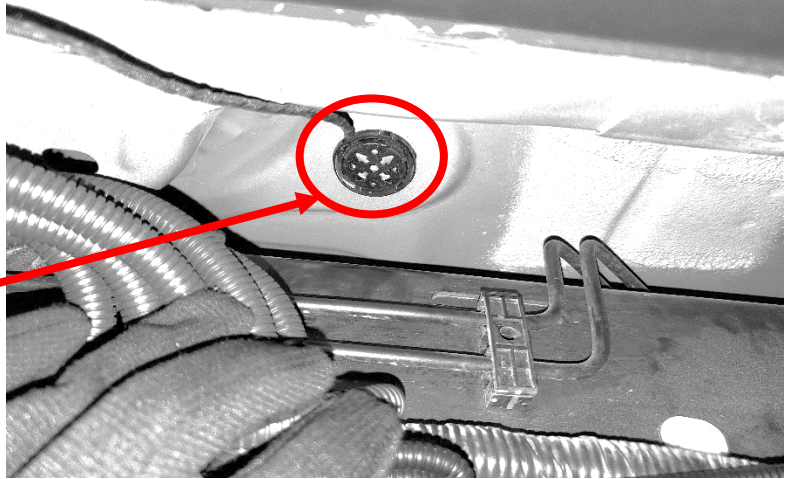

On some vehicles, it may be necessary to route through the engine bay firewall instead. In these cases, locate an oval grommet on the Driver Side of the firewall, and route through the grommet.

It is recommended to check on the inside of the cab to see where the wire is coming out through.

POV: Inside of cab, under steering wheel.

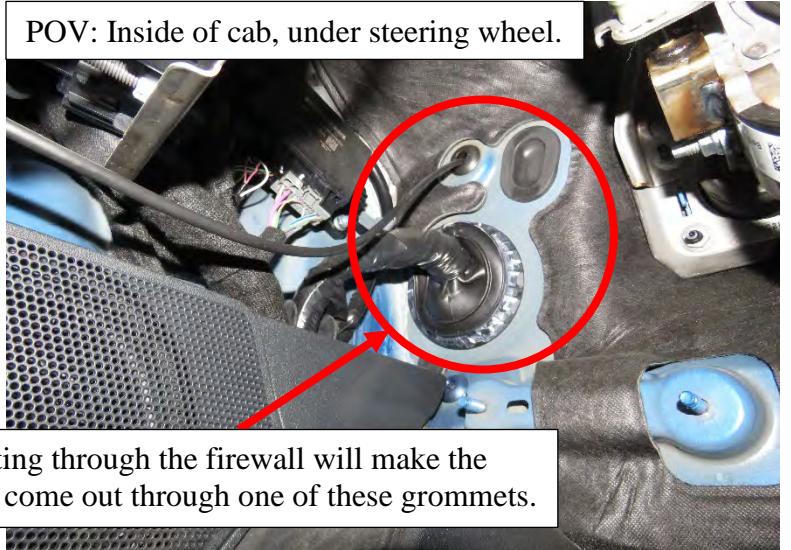

Routing through the firewall will make the wire come out through one of these grommets.

If routing through floor grommet, remove the driver-side front kick panel and bottom door sill plate. Peel back the carpet to access the hole where the grommet was removed. Feed the wires through.

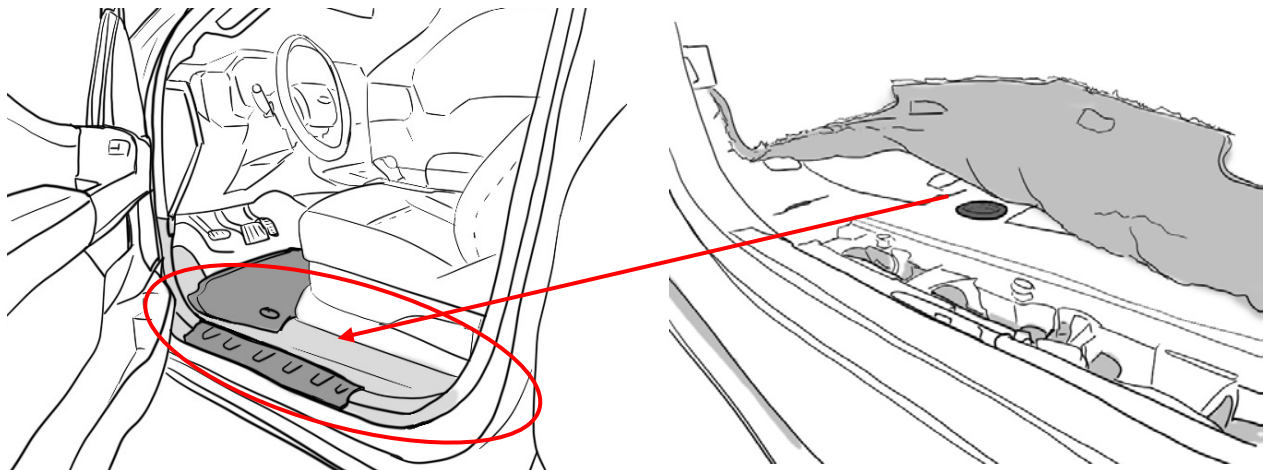

10

Attach the main harness (J) to one LED Y-Harness (K). Then attach the LED Y-Harness to the motor (do this for driver side first). Repeat for passenger side.

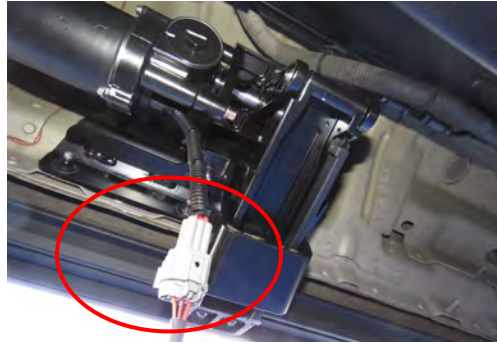

11

Locate the black BCM (body control module) under the steering wheel, behind the OBD-II Port and to the left side behind the kick panel. BCM module may be detachable.



On the black plug of the BCM, identify the Grey/Orange wire and Purple/Orange wire. Connect the Yellow and White signal wires from the Power Step Main Harness (J) using the supplied wire taps (L). (See next page for details)

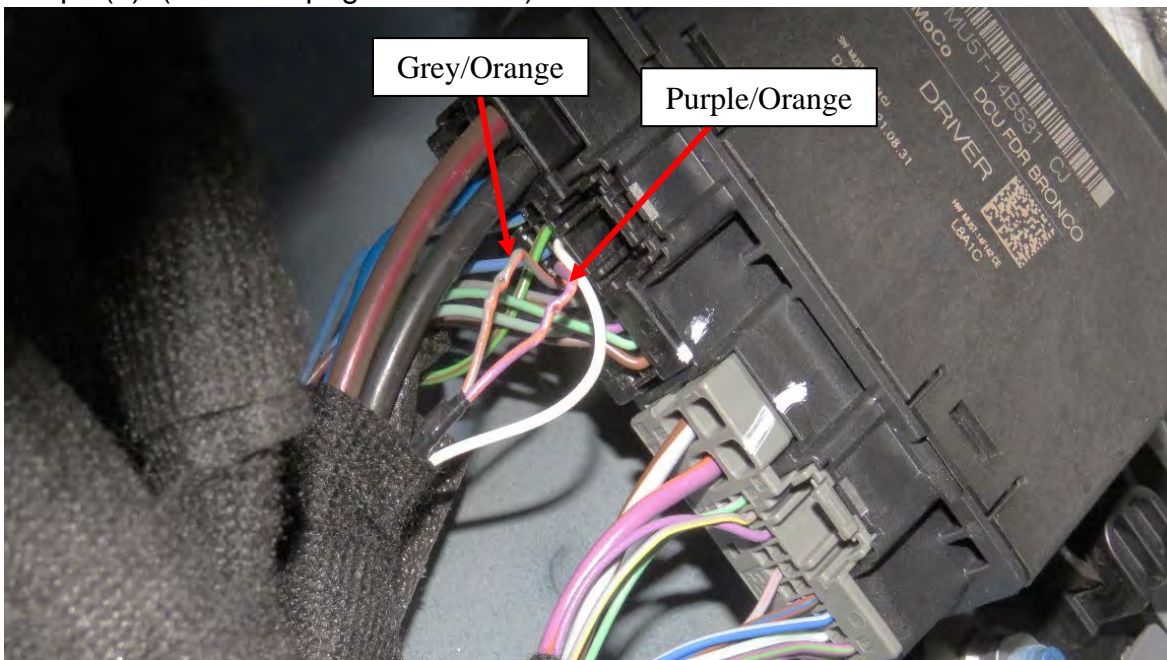

Factory CAN Wire/ Data Line	Power Step Main Harness Wire Color
Grey with Orange Stripe (Low)	Yellow (CAN-L)
Purple with Orange Stripe (High)	White (CAN-H)

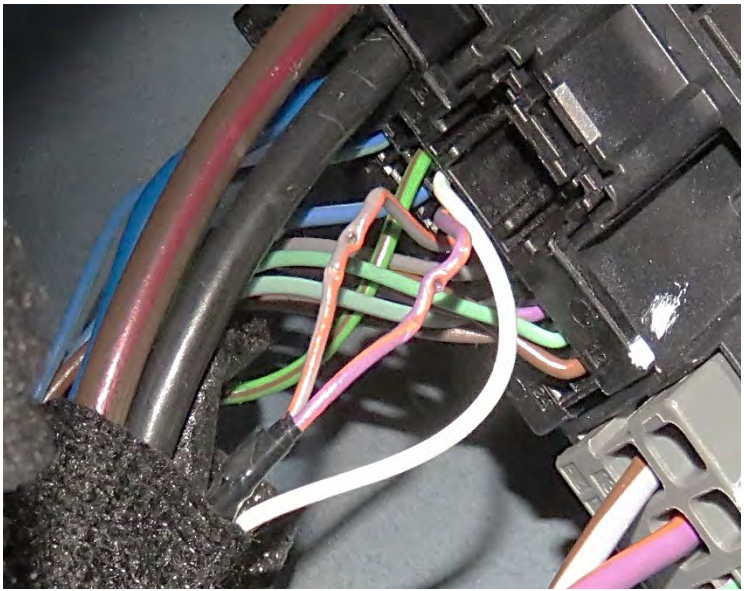

\*NOTE: If board does not move during troubleshooting, check to see if the taps tapped the wires correctly.

\*NOTE: On **2024+** models, the **GREY with Orange Stripe** wire is now **GREEN with Orange Stripe**.

The kit comes supplied with wire taps called “shark taps”. Follow the guide below to tap the wire using the “shark tap”:

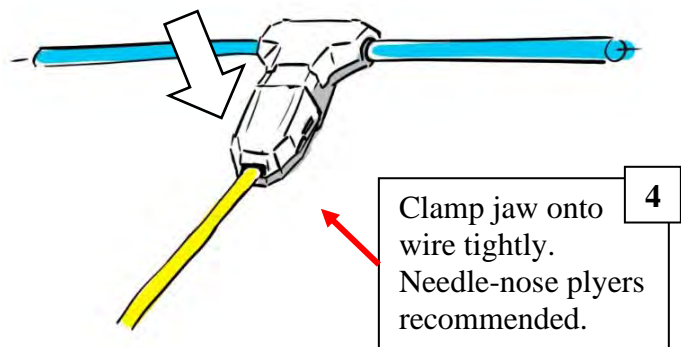
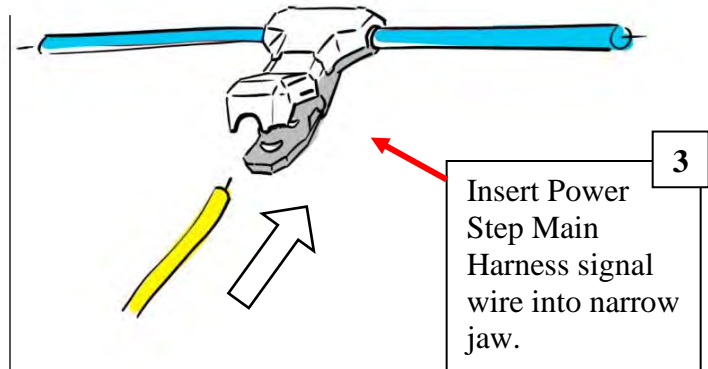
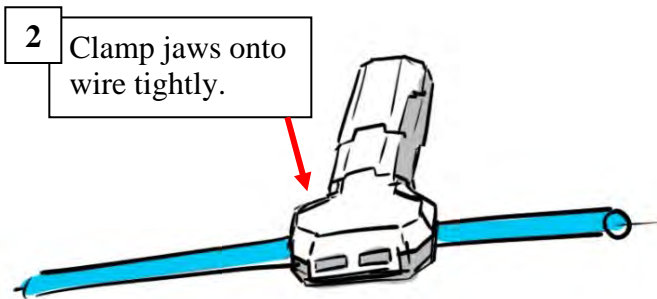
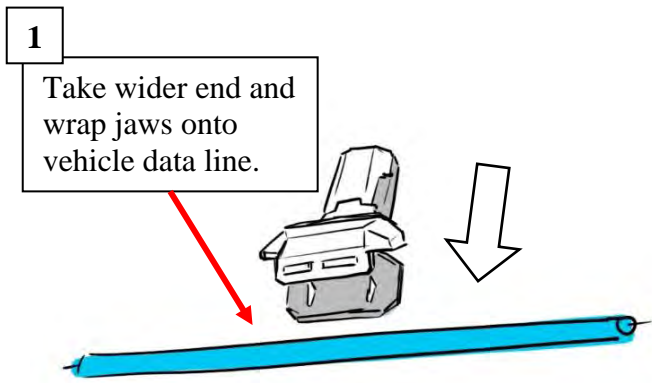

NOTE: Make sure wire is seated properly in the jaws before clamping. The wire being tapped must be centered on the “teeth” to make a proper tap.



# 12

Plug in LED lights (N) into LED Y-Harness (K) and attach them to the bottom of the rocker panel. Use provided 3M double sided adhesive tape on back of LED light (N). Replace Fuse into Fuse Box.

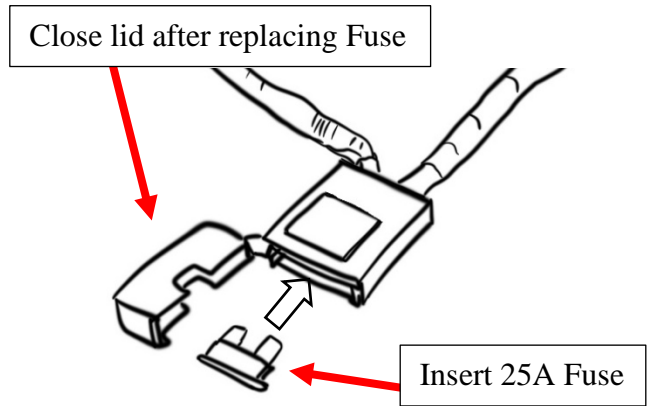
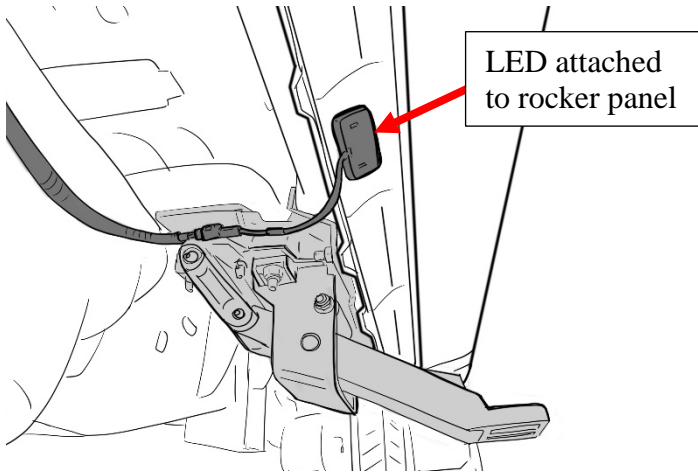

# 13

Check to make sure the harnesses on the Driver Side/Left Front Bracket Assembly (A) and Passenger Side Front Bracket Assembly (C) are connected to the main harness (J) via the LED-Y harnesses (K).

\*NOTE: The linkage arms on the front bracket assemblies will not move unless both motors are connected.

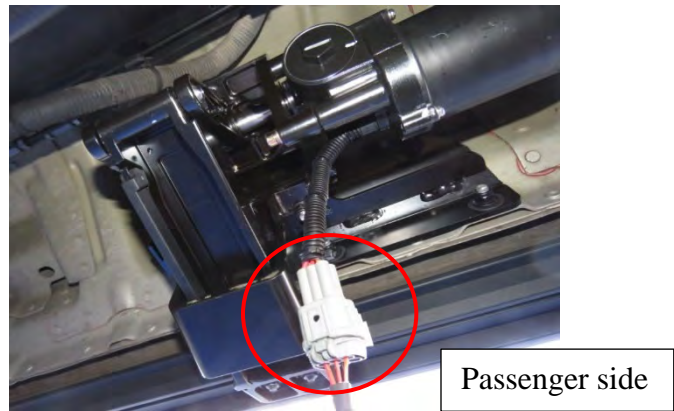

# 14

Seal the grommet with RTV Silicone Sealant.

Hide wires and reattach the kick panel with the carpet fully unfurled in its original position. Reattach the door sill panel and check to make sure there are no obstructions or potential snag points around the brake pedal area.

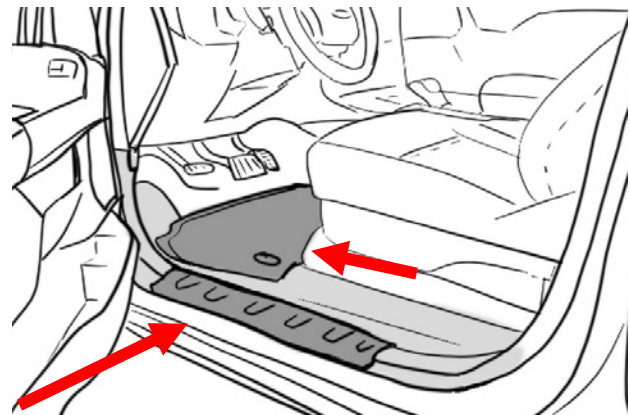

Prepare the power step boards. Locate the end of the boards and slide the M6 Carriage Bolts (E) into the channel on the underside of the board. Insert a total of 4 carriage bolts (E).

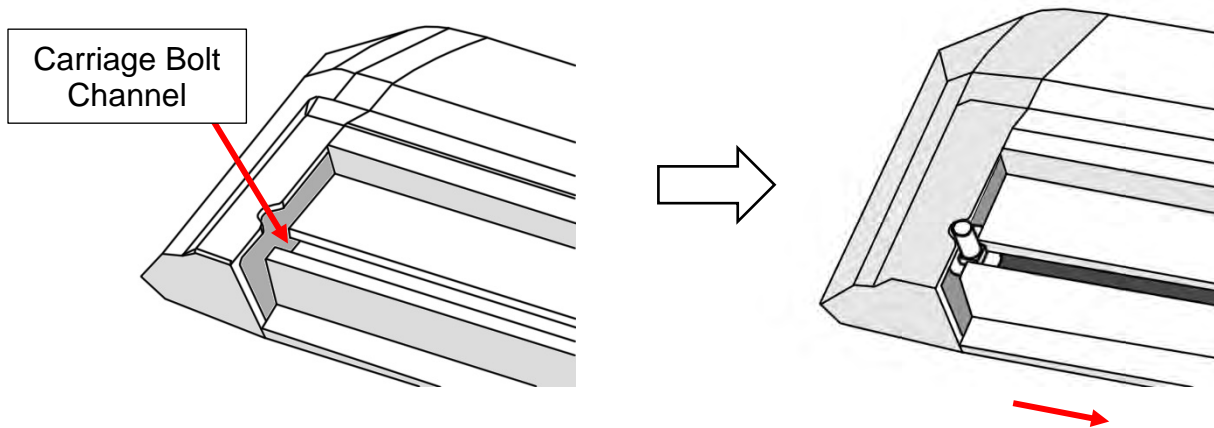

Use the notch in the board's end caps to feed the bolts into the channel.

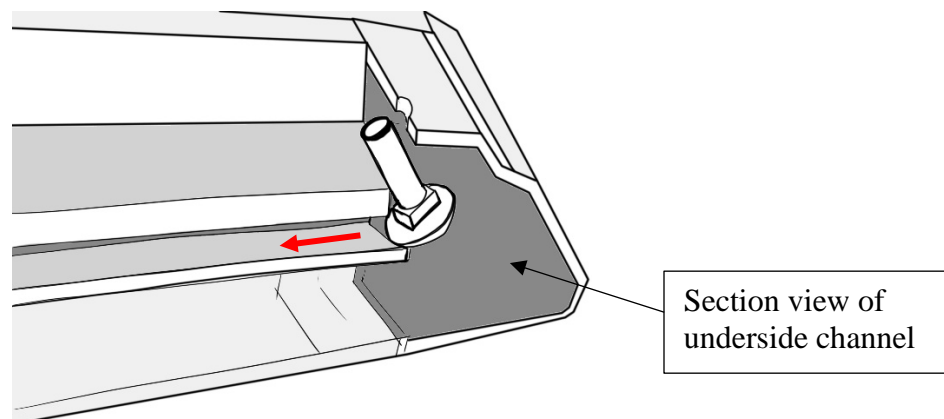

**16** Perform a function check by closing the driver side front door and opening it again. The front bracket assembly (A) motor should activate the linkage arm and move it into the down or “deployed” position.

After deploying linkage arms, unplug main harness connector while front door is open to hold the board in the deployed position for running board installation.

Line up the carriage bolts (E), under the power step boards, with the slots on the linkage arms (A & B). Insert the 4 carriage bolts (E) into the slots on front and rear linkage arms. Adjust board to desired position. Moderately hand tighten the flange nuts (G) onto the carriage bolts.

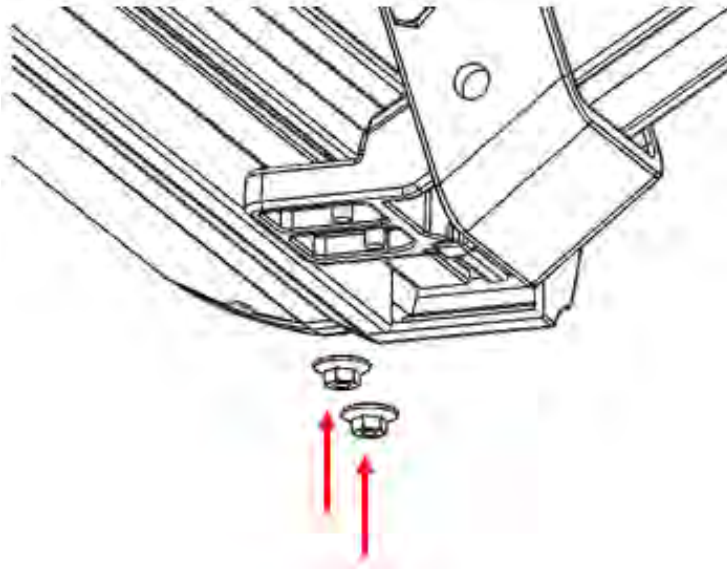

Once the board is adjusted, plug in main harness (J) connector to return power to the linkage arms. Open and close doors several times to deploy and retract the steps to settle the steps into their natural alignment. After cycling the step, tighten all hardware on the board and brackets.

Some further adjustment may be required for desired step position. Repeat for passenger side.

**17** Perform system check and troubleshooting. If board is making irregular movements or noise, readjust the boards as follows:

- a) With board deployed loosen 6mm flange nuts under board.
- b) Leave the flange nuts slightly less than snug.
- c) Open and close door several times for board to settle into position.
- d) With the step in the deployed position, gradually tighten flange nuts while alternating between each. Do not over tighten.

If board is making abnormal noise or the motion is binding, repeat steps “a” through “d”.

Note: If the above method does not resolve the issue, the brackets mounting to the vehicle may not be aligned properly with the vehicle. In this case, remove the board and realign brackets before attempting steps “a” to “d” once again.

Reinstall any remaining trim panels if necessary. Check and make sure all hardware is fully tightened. Perform a final system check. Finish.



\*NOTE: If board does not move during troubleshooting, flip the CAN Signal High and Low wires.

\*NOTE: Bronco Factory Doors must be plugged in for the power steps to work. If doors are removed, the power step will stay in the retracted (up) position.