



TEL: 1-866-XANATOS

INSTALLATION INSTRUCTIONS

PART # RN-TOTU-79

CUTLASS RUNNING BOARDS

07-15 TOYOTA TUNDRA DOUBLE CAB

PARTS LIST:

1	Driver Sidebar	1	Driver/Left Rear Mounting Bracket
1	Passenger Sidebar	1	Passenger/Right Rear Mounting Bracket
1	Driver/Left Front Mounting Bracket	12	8mm T-Bolts
1	Passenger/Right Front Mounting Bracket	12	8-1.25mm x 30mm Hex Bolts
1	Driver/Left Center Mounting Bracket	24	8mm Lock Washers
1	Passenger/Right Center Mounting Bracket	24	8mm x 24mm OD x 2mm Flat Washers
		12	8mm Hex Nuts

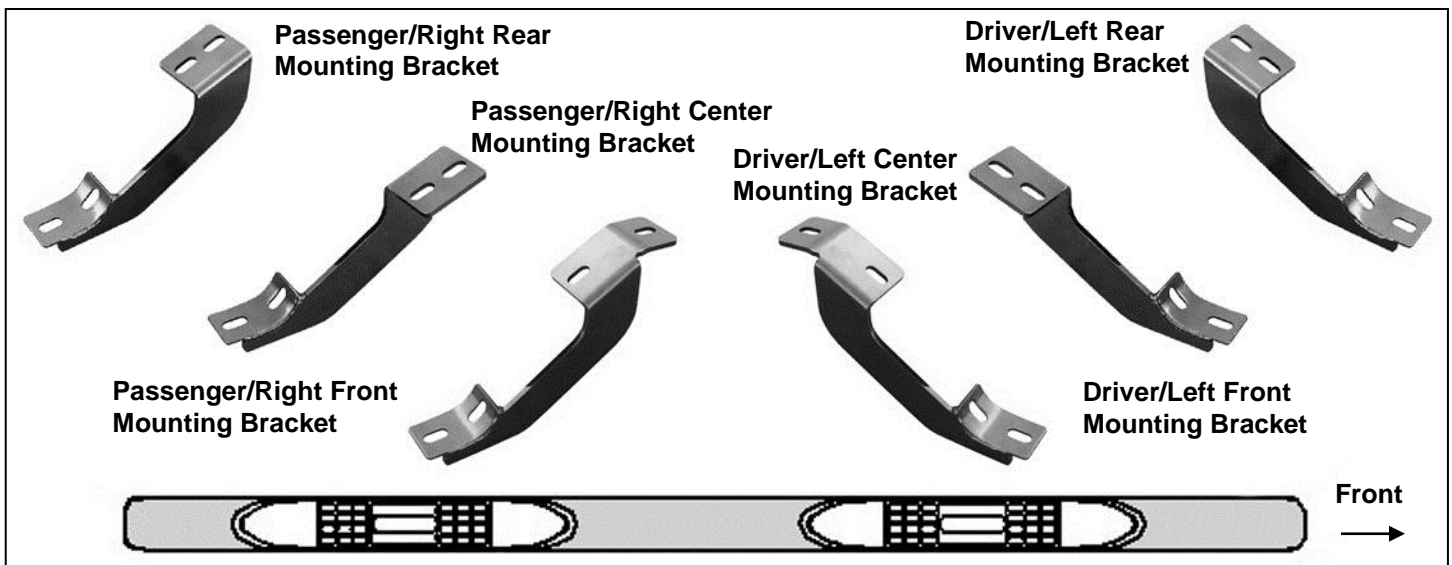

PROCEDURE:

- 1. REMOVE CONTENTS FROM BOX. VERIFY ALL PARTS ARE PRESENT. READ INSTRUCTIONS CAREFULLY.**
- Starting on the driver side front of the vehicle, remove the plastic plugs or hex bolts from the forward factory mounting location, **(Figure 1)**. **IMPORTANT:** There are (4) mounting locations along the body, installation will use the 1st, 2nd and 4th locations only.
- Partially attach the driver side front Mounting Bracket to the vehicle using the included (2) 8mm x 30mm Hex Bolts, (2) 8mm Lock Washers and (2) 8mm Flat Washers, **(Figure 2)**. Leave hardware loose at this time.
- Repeat **Step 2** for center, **(Figures 3 & 4)**, and rear Bracket installation, **(Figure 5)**.
- Select the driver Sidebar. Locate the opening in the end of each channel in the bottom of the Sidebar. Slide (3) 8mm T-Bolts into each channel, **(Figure 6)**. Carefully position the Sidebar onto the (3) Mounting Brackets. Lift the Sidebar up and slide the T-Bolts along the Sidebar to match up with the Brackets. **IMPORTANT:** Do not slide, (front to back or rotate), the Sidebar on the Brackets or damage to the finish on the Sidebar may result.
- Line up the front of the Sidebar approximately 2" back, (or locate as desired), from the front wheel opening. Attach the Sidebar to the Mounting Brackets with (6) 8mm Flat Washers, (6) 8mm Lock Washers and (6) 8mm Hex Nuts, **(Figure 7)**. Do not tighten hardware at this time.
- Level and adjust the Sidebar properly and tighten all hardware.
- Repeat **Steps 2—7** for passenger Sidebar installation.
- Do periodic inspections to the installation to make sure that all hardware is secure and tight.

To protect your investment, wax this product after installing. Regular waxing is recommended to add a protective layer over the finish. Do not use any type of polish or wax that may contain abrasives that could damage the finish.

For stainless steel: Aluminum polish may be used to polish small scratches and scuffs on the finish. Mild soap may be used also to clean the Sidebar.

For gloss black finishes: Mild soap may be used to clean the Sidebar.

Driver Side Installation Pictured

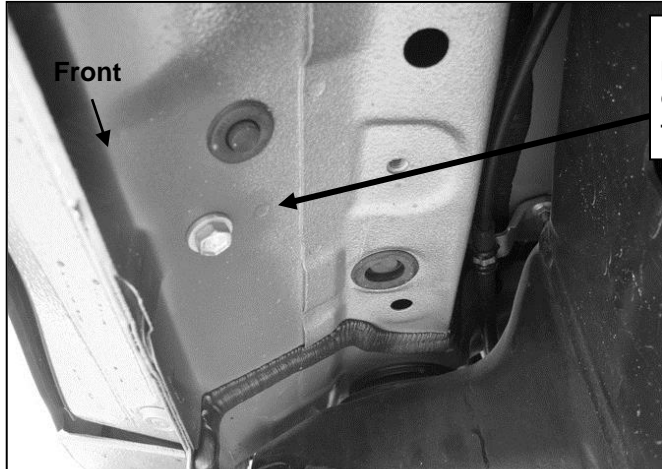

Remove plastic plugs (if equipped) or hex bolts from threaded holes

8mm x 30mm Hex Bolts
8mm Lock Washers
8mm Flat Washers

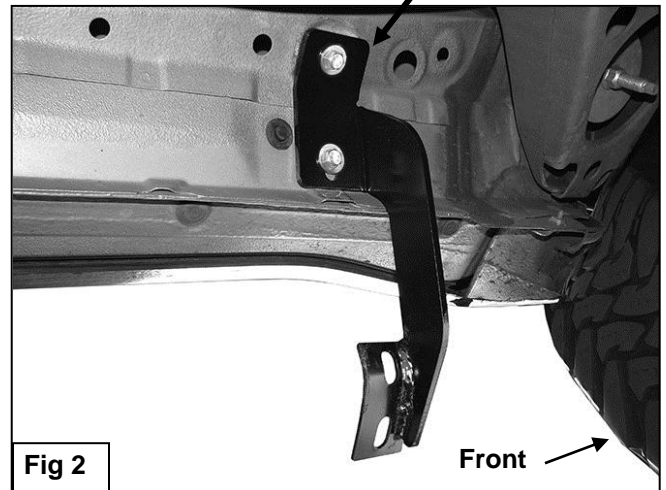
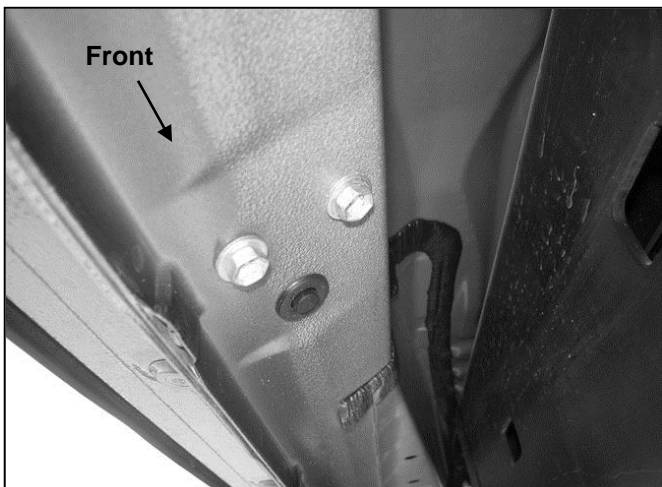

Fig 2

(Fig 1) Driver/Left Front Mounting Location Pictured

There are four sets of threaded holes in the side panel. Starting from the front of the vehicle, use the first, second, and fourth sets of holes.



8mm x 30mm Hex Bolts
8mm Lock Washers
8mm Flat Washers

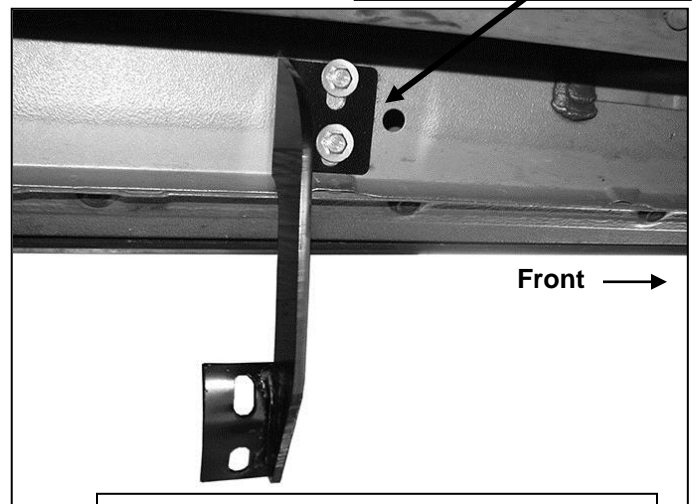

(Fig 4) Driver/Left Center Bracket Pictured

(Fig 3) Driver/Left Center (2nd) Mounting Location

Driver Side Installation Pictured



(Fig 5) Driver/Left Rear Bracket installed



(Fig 6) Slide (3) 8mm T-Bolts into each channel on bottom of Sidebar

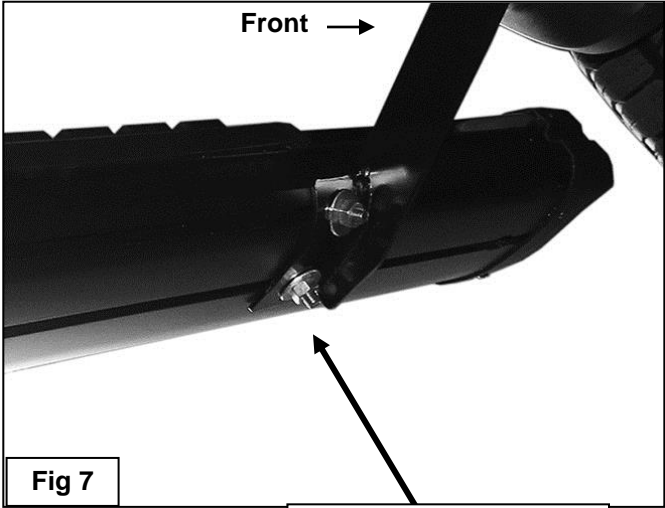
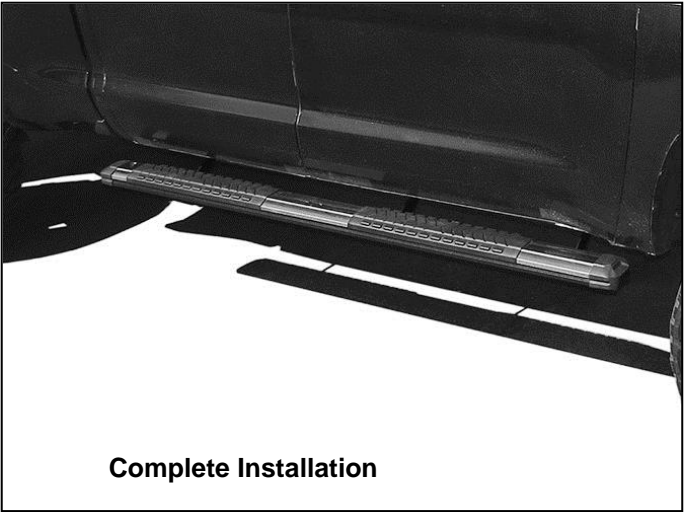

Fig 7

**(2) 8mm Flat Washers
(2) 8mm Lock Washers
(2) 8mm Hex Nuts**



Complete Installation