



**INSTALLATION INSTRUCTIONS**  
**VORTEX RUNNING BOARD FOR HONDA ODYSSEY 18-20**  
**PART # VO-H1882**



## Before Installation

- Please read the instruction completely for easy installation, which will also help you to avoid scratches or other potential damages to your appealing car.
- The figures here are for reference only and may have differences with the actual product you received, however they share the same assembly way.

## Care and Cleaning

- Mild soap may be used also to clean the Product.
- Please periodically check and retighten all the hardware and clean the investment for a refresh look.

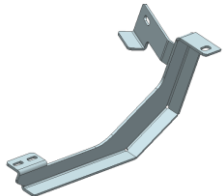
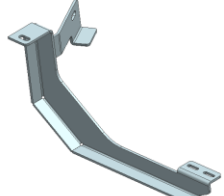
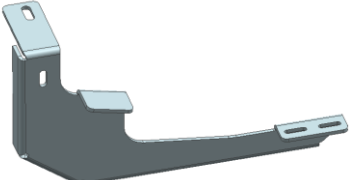
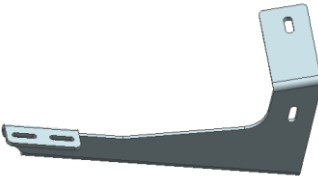
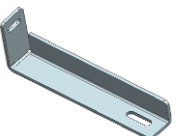
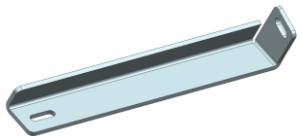
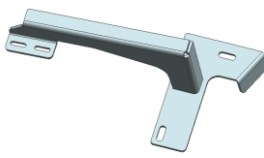
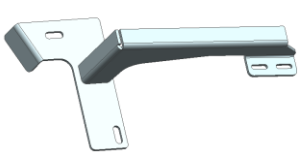
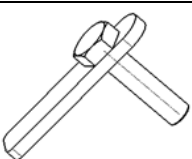
## Parts list

NO.	QTY	PIC	NO.	QTY	PIC
①	1	 Front bracket (L)	②	1	 Front bracket (R)
③	1	 Middle bracket (L)	④	1	 Middle bracket (R)
⑤	1	 Middle mounting bracket (L)	⑥	1	 Middle mounting bracket (R)
⑦	1	 Rear bracket (L)	⑧	1	 Rear bracket (R)
⑨	10	 T Bolt M10	⑩	10	 M10 Plastic block

Standard parts:

⑪	2	Lock washer D8	⑮	10	Lock washer D10
⑫	6	Flat washer D8	⑯	10	Flat washer D10
⑬	2	Hex nut M8	⑰	10	Hex nut M10
⑭	2	Hex bolt M8_25			

**Installation Steps**

**INSTALLING PICTURE:**

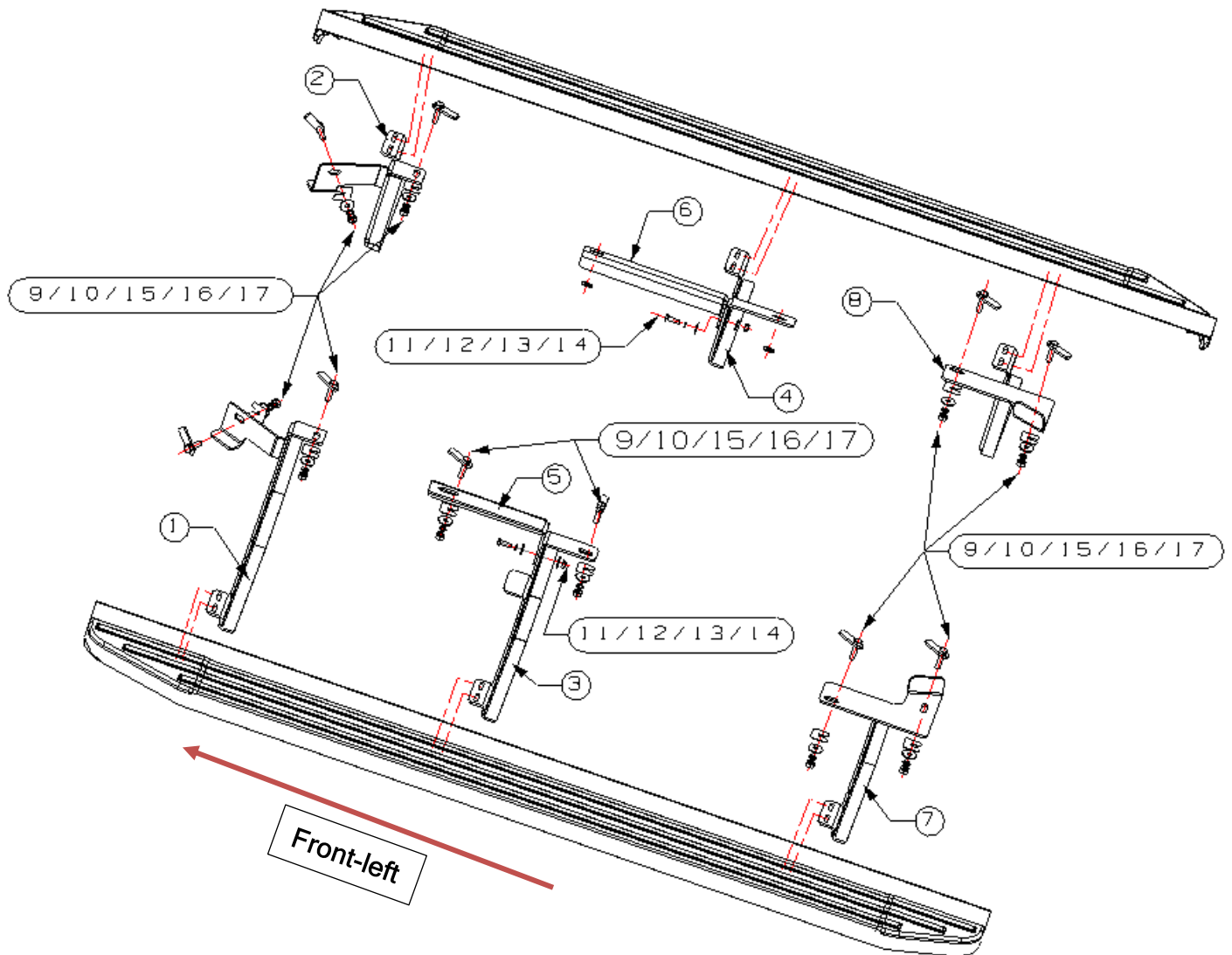

Step 1: Preview the approximate position of the body scan data and bracket in the picture below, and then install the brackets according to the actual car picture.

Front-left

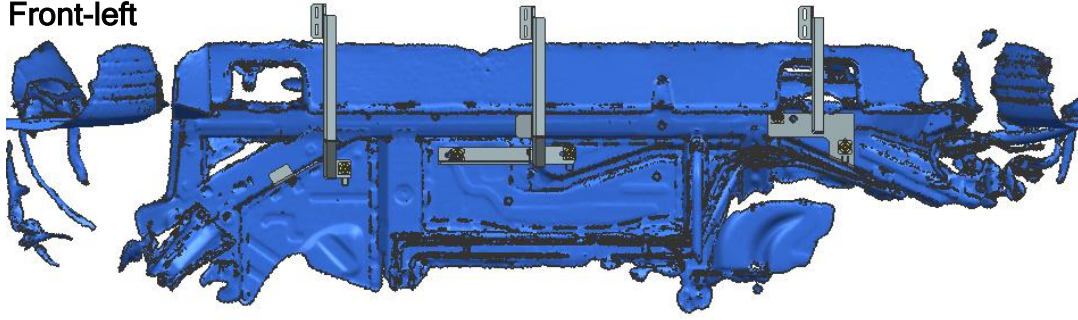

Front-right

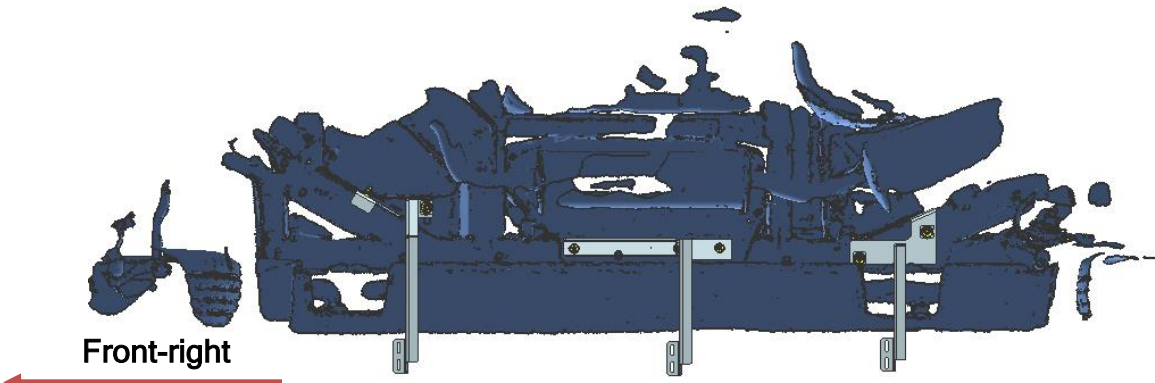

The installation of the front bracket (L) is as follows: (see the INSTALLING PICTURE for the optional standard parts). The left and right installation methods are the same.

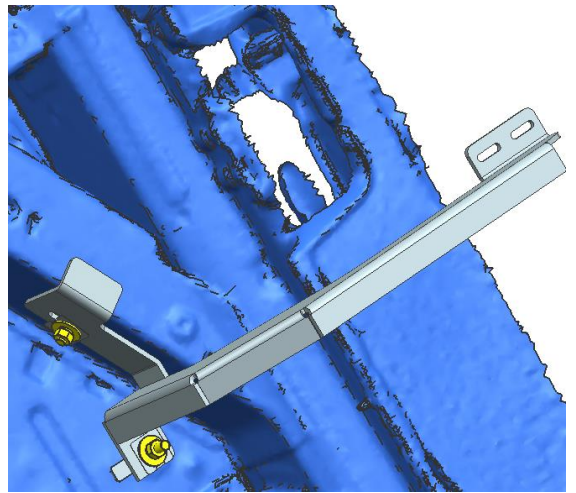

The installation of the middle bracket (L) is as follows: (see the INSTALLING PICTURE for the optional standard parts).

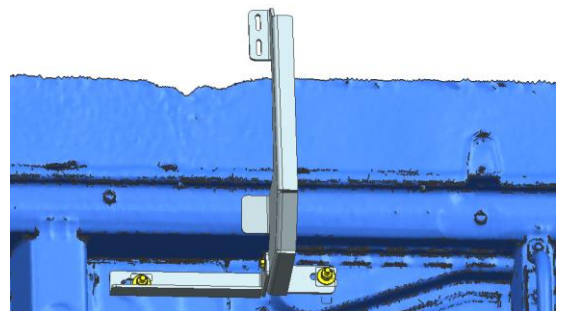

The installation of the middle bracket (R) is as follows: (see the INSTALLING PICTURE for the optional standard parts).



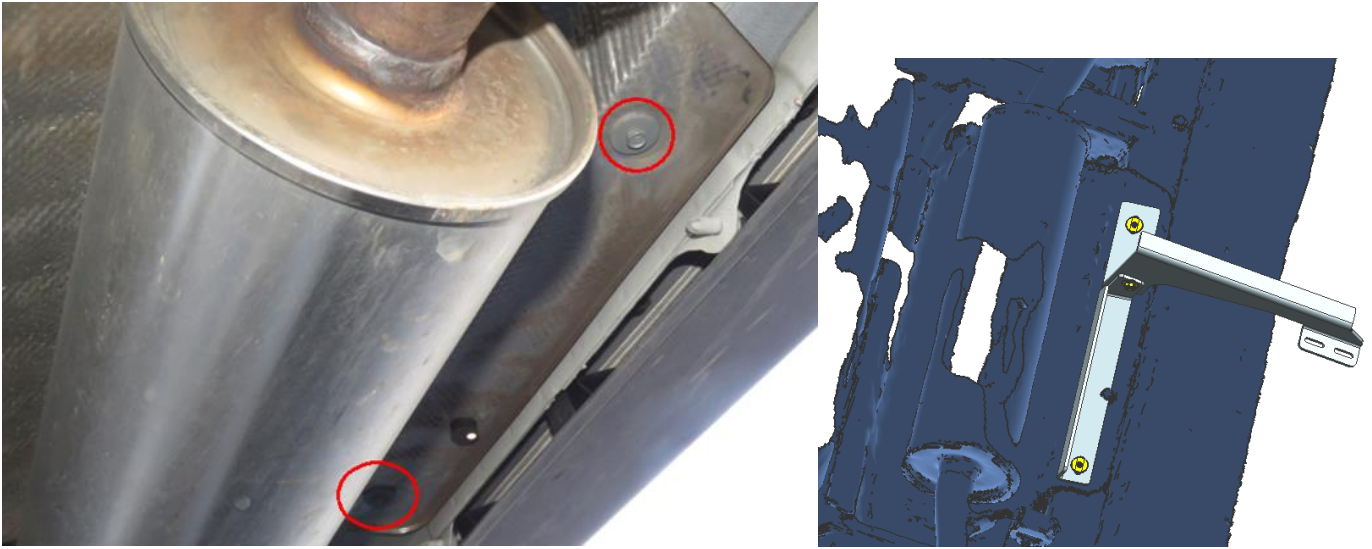

The installation of the rear bracket (L) is as follows: (see the INSTALLING PICTURE for the optional standard parts). The left and right installation methods are the same.

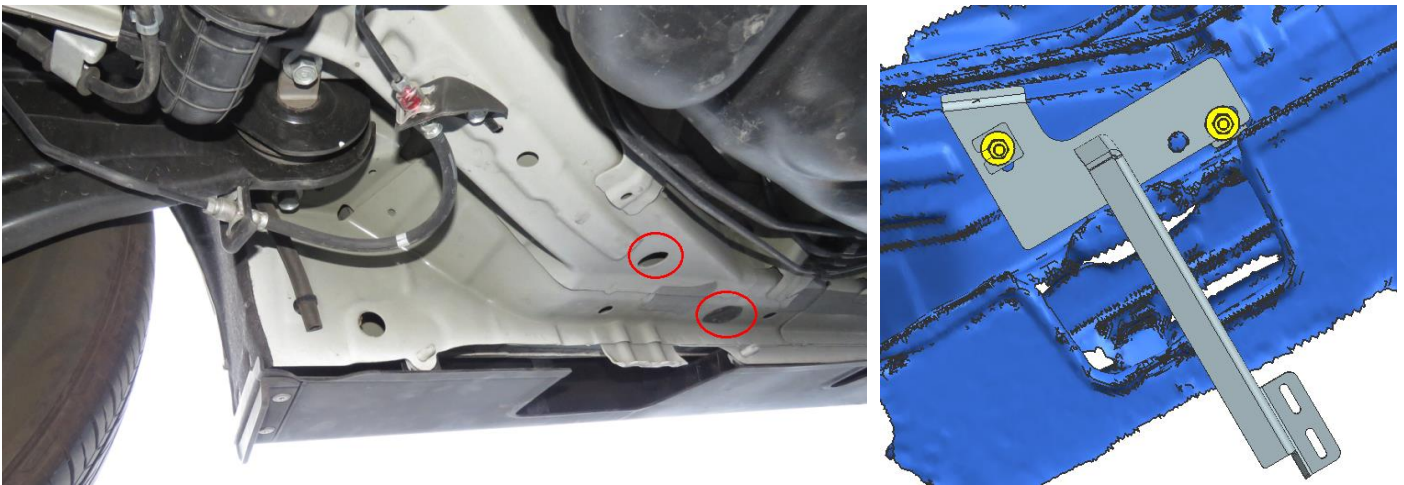

Step 2: The overall effect after installation is shown in the figure below.



Step 3: Installation is finished, pick up all tools.

**NOTE**

Any damages and losses caused by improper installation and application, goes beyond our quality warranty.