

S/S MUODULAR GRILLE GUARD
FOR JEEP GRAND CHEROKEE 2011-20 Excl. SRT, EcoDiesel , Trail Hawk & Summit Models



INSTALLATION INSTRUCTIONS

S/S MUODULAR GRILLE GUARD

**FOR JEEP GRAND CHEROKEE 2011-20 Excl. SRT, EcoDiesel , Trail Hawk
& Summit Models**

PART # 17A080202MSS

PARTS LIST:

1	Grille Guard	4	10mm x 20mm OD x 2.5mm Small Flat Washers
1	Driver/Left Side Mounting Bracket	4	10mm Lock Washers
1	Passenger/Right Side Mounting Bracket	2	10mm Nylon Lock Nuts
1	Driver/Left Side Top Bracket	4	6mm x 18mm OD x 1.6mm Flat Washers
1	Passenger/Right Side Top Bracket	1	50mm x 400mm Adhesive-backed Foam Tape
6	12-1.75mm x 35mm Hex Bolts	12	Flat washer D8(8x24x2mm)
12	12mm x 32mm OD x 3mm Flat Washers	6	Spring washer D8
6	12mm Lock Washers	6	Nut M8
6	12mm Hex Nuts	6	Button Head Bolt M8_25
2	10-1.5mm x 30mm Button Head Bolts	1	Left Brush Guard
4	10-1.5mm x 35mm Hex Bolts	1	Right Brush Guard
4	10mm x 27mm OD x 3mm Large Flat Washers		

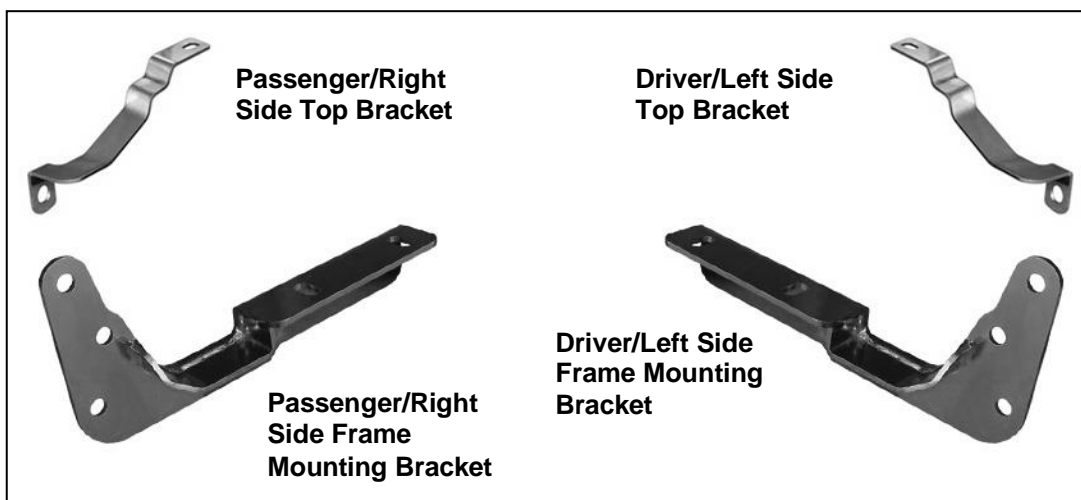

PROCEDURE:

- REMOVE CONTENTS FROM BOX. VERIFY ALL PARTS ARE PRESENT. READ INSTRUCTIONS CAREFULLY BEFORE STARTING INSTALLATION. ASSISTANCE IS HIGHLY RECOMMENDED.**

IMPORTANT: This Grille Guard may not be compatible with optional Adaptive Cruise Control-Forward Collision Warning Systems featuring grille mounted laser control sensor.

- Determine if the vehicle is equipped with or without factory tow hooks, **(Figure 1)**. Remove the plastic splash guard under the front bumper cover, **(Figure 2)**.
Vehicles with factory tow hooks: Remove both tow hooks if equipped and proceed to **Step 3**.
NOTE: Tow hooks cannot be reinstalled with the Grille Guard.
Vehicles without factory tow hooks:
 - 2011-13:** Remove the factory hardware securing the ends of the bumper cover. Release the clips at the ends of the plastic bumper cover that attach the lower cover to the upper cover, **(Figure 3)**. **NOTE:** It is not necessary to remove the lower bumper cover, only release the clips at both ends of the cover. Next, remove the (3) clips fastening the air deflector to the bottom of the crossmember, **(Figure 4)**. Carefully pull the bumper cover forward for access and pull the air deflector out from behind the bumper cover, **(Figure 5A)**. Release the (2) clips and remove the

S/S MUODULAR GRILLE GUARD

FOR JEEP GRAND CHEROKEE 2011-20 Excl. SRT, EcoDiesel , Trail Hawk & Summit Models

block-off cover at each end of the air deflector, **(Figure 5B)**. Reinstall the air deflector, (without block-offs), and bumper cover using the factory hardware.

- b. 2014 Models:** The block offs covering the openings in the bumper are clipped onto the back of the bumper cover only, **(Figure 6)**. Remove the hardware at the bottom of the inner fender panel, **(Figure 7)**. Reach up behind the bumper to release the clips and remove the block off from each opening in the bumper cover, **(Figures 8 & 9)**. No other disassembly is required.
- 3.** Locate the (2) threaded holes in the bottom of the frame channel, **(Figure10)**. Select the driver side Frame Mounting Bracket. Hold the Bracket with the mounting tab flat, **(Figure11A)** insert it through the opening and rotate up into position in line with the factory threaded holes, **(Figure11B)**. Bolt the Bracket to the frame channel with (2) 10mm x 30mm Hex Bolts, (2) 10mm Large Flat Washers and (2) 10mm Lock Washers, **(Figure 12)**. Snug but do not fully tighten the hardware at this time. Repeat this step for passenger side Frame Bracket installation.
- 4.** With assistance, hold the Grille Guard up to the outside of the Mounting Brackets. Attach the Grille Guard to the Mounting Brackets with the included (6) 12mm x 35mm Hex Bolts, (12) 12mm Flat Washers, (6) 12mm Lock Washers and (6) 12mm Hex Nuts, **(Figure 13)**. **WARNING!** Do not allow Grille Guard to come in contact with the vehicle. Temporarily tighten hardware at this time to hold the Grille Guard in position.
- 5.** Open the front hood. Locate and remove the factory 6mm hex bolt on the driver side securing the plastic cover to the radiator support, **(Figure 14)**. Use the included (2) 6mm Flat Washers as spacers to fit into the recess in the plastic cover. Select the driver side Top Bracket. Apply a layer of Adhesive-backed Foam Tape to the bottom of the Top Bracket to protect the plastic cover, **(Figures 15A & 15B)**. Place the Top Bracket on top of the washers and bolt it to the radiator support using the factory hex bolt, **(Figure 16)**. **NOTE:** For proper fit, the Top Brackets must fit as close to the plastic cover and the top of the grille as possible for hood closure.
- 6.** Line up the mounting hole in the Top Bracket with the hole in the Grille Guard upright. Bolt the Bracket to the Grille Guard with (1) 10mm x 30mm Button Head Bolt, (2) 10mm x 20mm Small Flat Washers and (1) 10mm Nylon Lock Nut, **(Figures 16 & 17)**. Do not tighten hardware at this time.
- 7.** Repeat **Steps 5 & 6** for passenger side Top Bracket installation.
- 8.** Align and adjust the Grille Guard and tighten all hardware.
- 9. VERY IMPORTANT: Slowly close the hood** to check for clearance between the hood and the Top Brackets. Adjust the Top Brackets as necessary for proper hood closure.
- 10.** Do periodic inspections to the installation to make sure that all hardware is secure and tight.

To protect your investment, wax this product after installing. Regular waxing is recommended to add a protective layer over the finish. Do not use any type of polish or wax that may contain abrasives that could damage the finish.

For stainless steel: Aluminum polish may be used to polish small scratches and scuffs on the finish. Mild soap may be used also to clean the Grille Guard.

For gloss black finishes: Mild soap may be used to clean the Grille Guard.

Driver Side Installation Pictured

Remove splash guard under front bumper

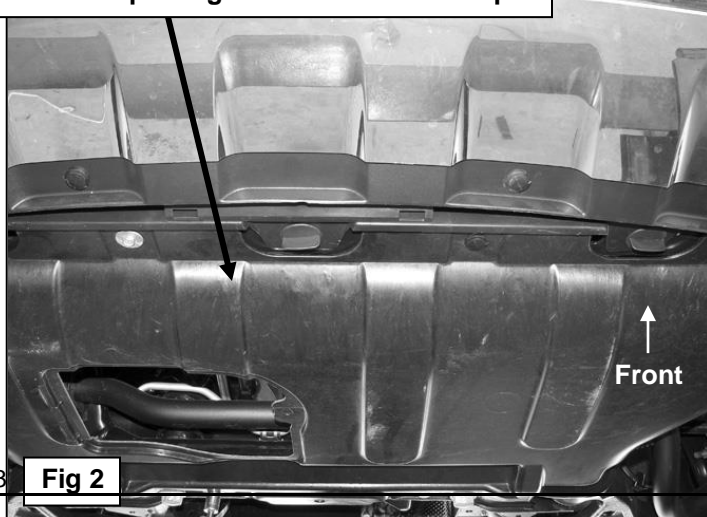

Fig 1

For vehicles with factory tow hooks, proceed to Figure 6

Driver Side Installation Pictured



Fig 3

2011-13 vehicles: Remove factory hardware and release clips at ends of lower bumper cover only. Do not remove lower bumper cover. (For vehicles without factory tow hooks only)

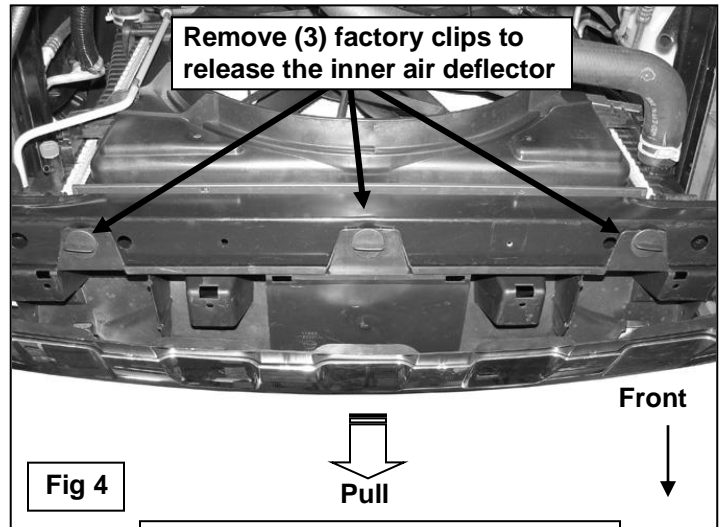
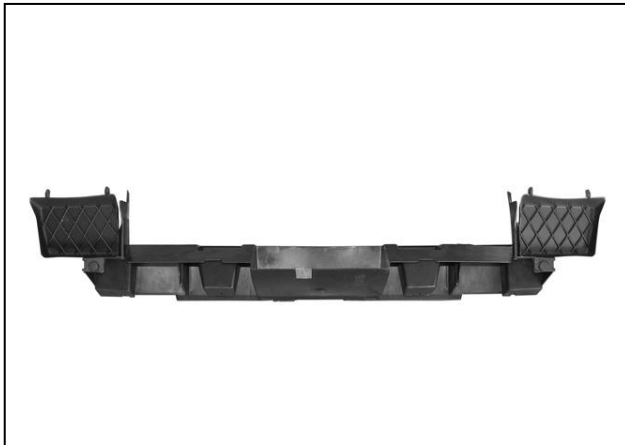

Fig 4

Carefully pull bumper cover forward and remove inner air deflector



(Fig 5A) 2011-13 Models: Inner air deflector assembly-applies to vehicles without tow hooks

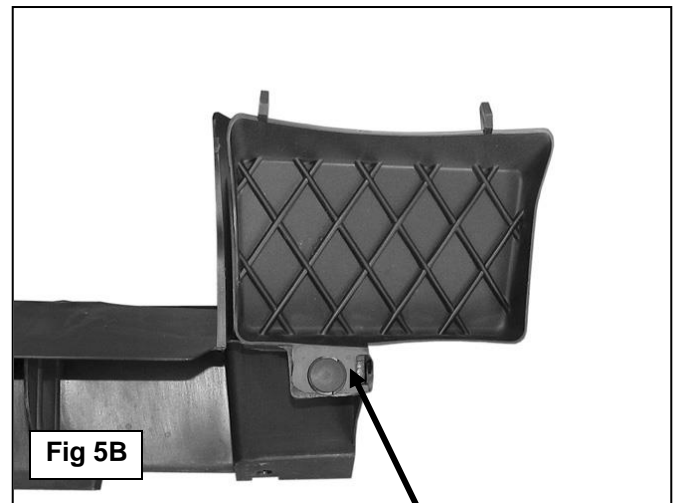

Fig 5B

Remove (2) factory clips to remove the block off cover from each end of the air deflector. 2011-13 driver side of air deflector pictured



(Fig 6) 2014 driver side pictured

Driver Side Installation Pictured

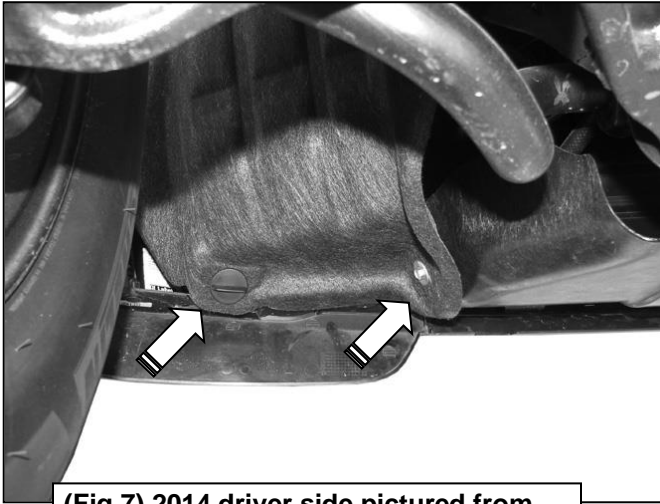

(Fig 7) 2014 driver side pictured from behind bumper. Remove factory hardware to access mounting location (Fig 10) on bottom of frame channel

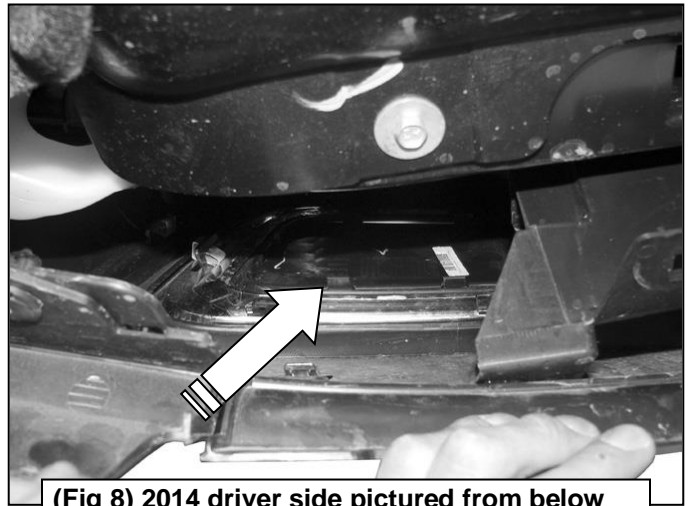

(Fig 8) 2014 driver side pictured from below front bumper. Carefully pull the air dam slightly forward and reach up between bumper cover and radiator support to access and remove block offs

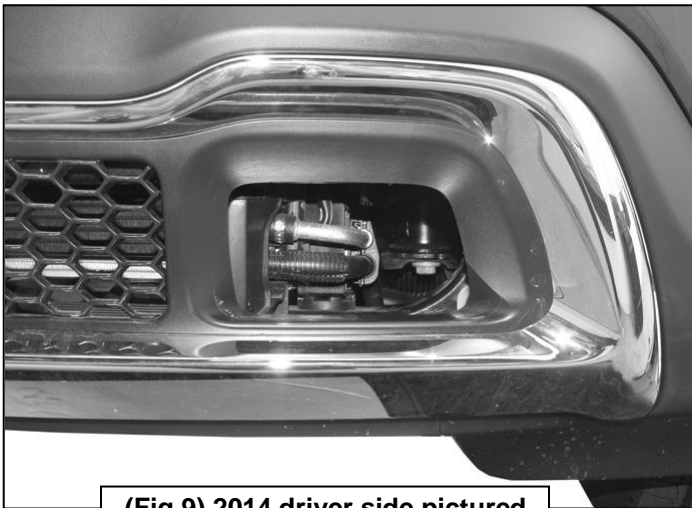

(Fig 9) 2014 driver side pictured

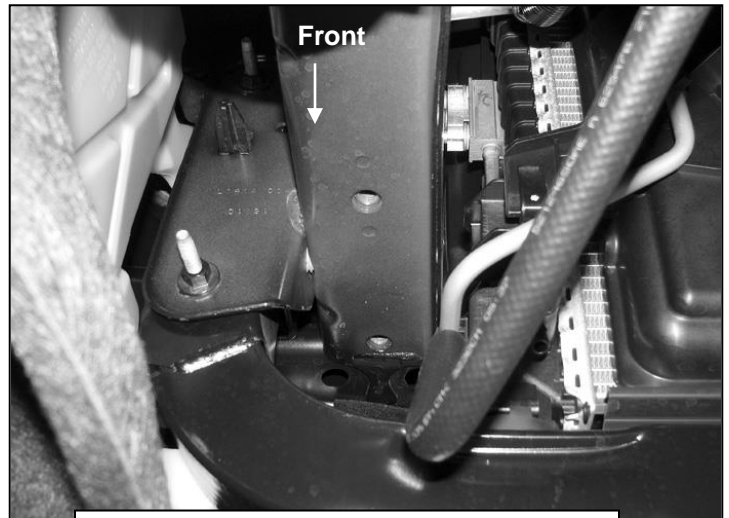

(Fig 10) Driver side mounting location pictured from below and behind bumper

Driver Side Installation Pictured

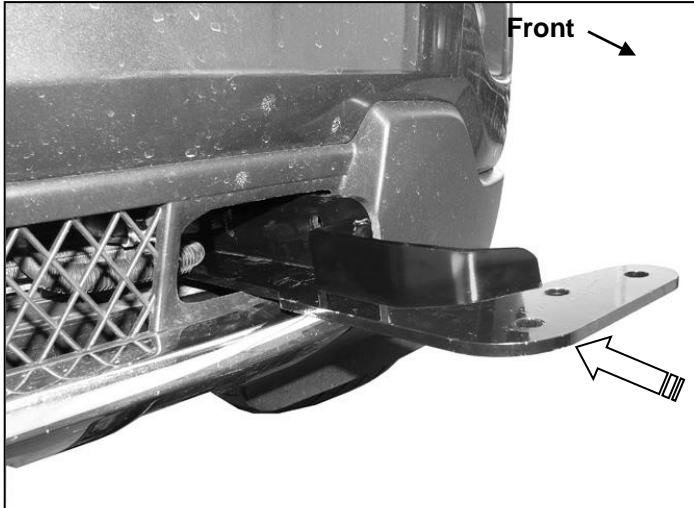

(Fig 11A) Slide the Bracket into the tow hook opening

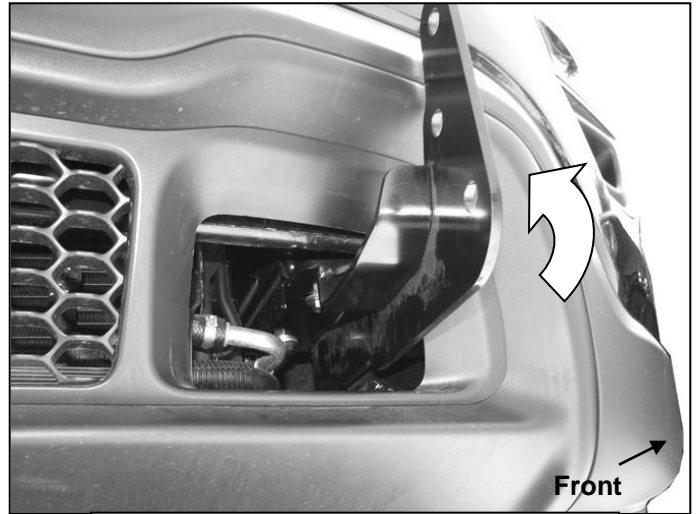

(Fig 11B) Rotate the Bracket to meet the mounting holes for the tow hooks

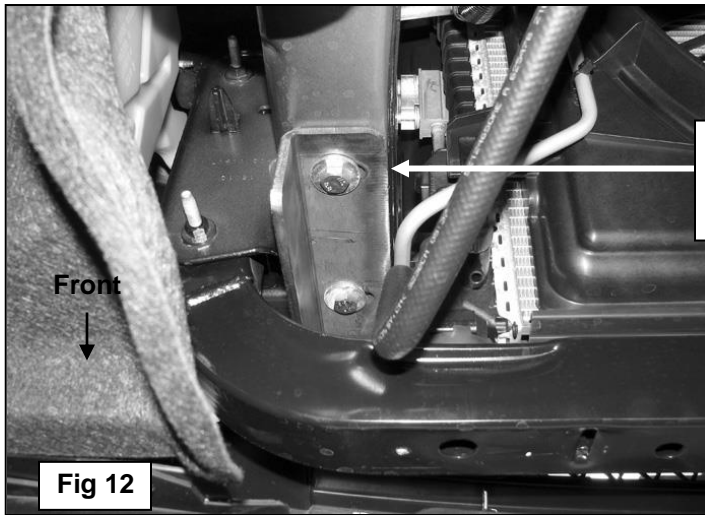

Fig 12

- (2) 10mm x 35mm Hex Bolts**
- (2) 10mm Lock Washers**
- (2) 10mm x 27mm Large Flat Washers**

- (3) 12mm x 35mm Hex Bolts**
- (3) 12mm Lock Washers**
- (6) 12mm Flat Washers**
- (3) 12mm Hex Nuts**

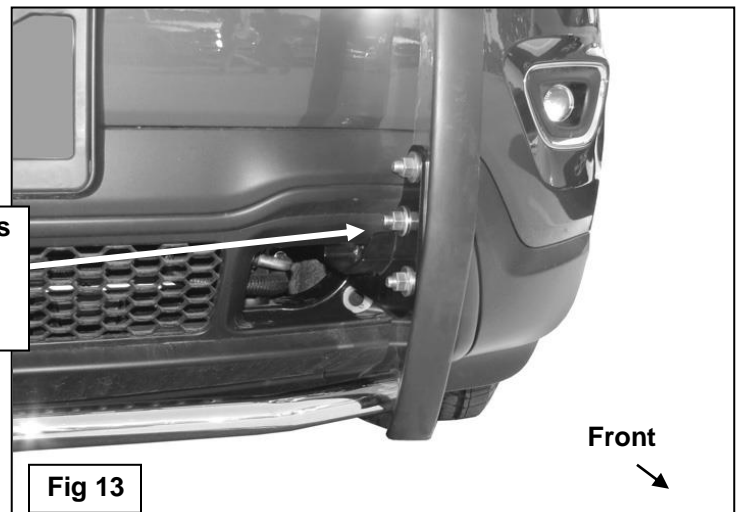
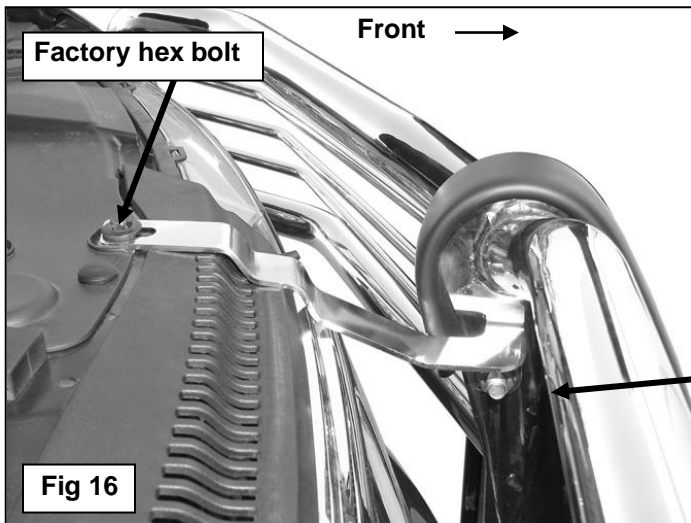
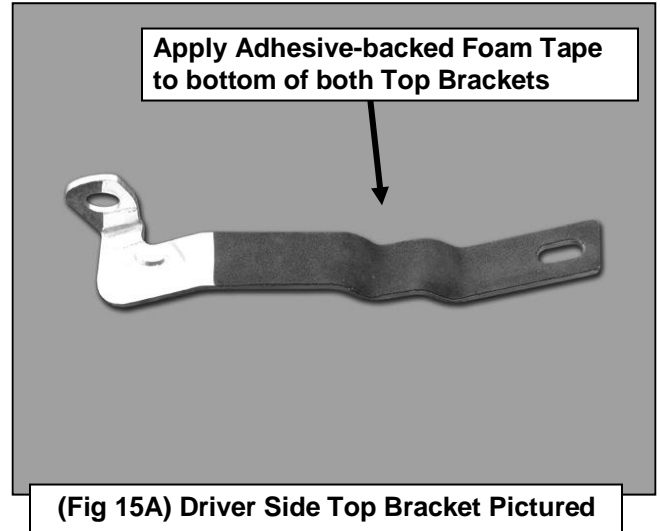
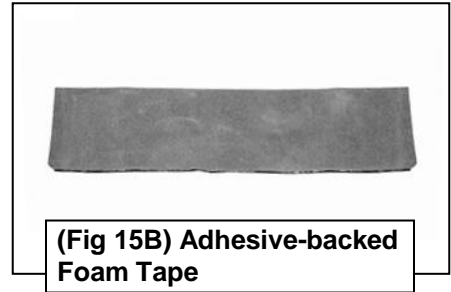
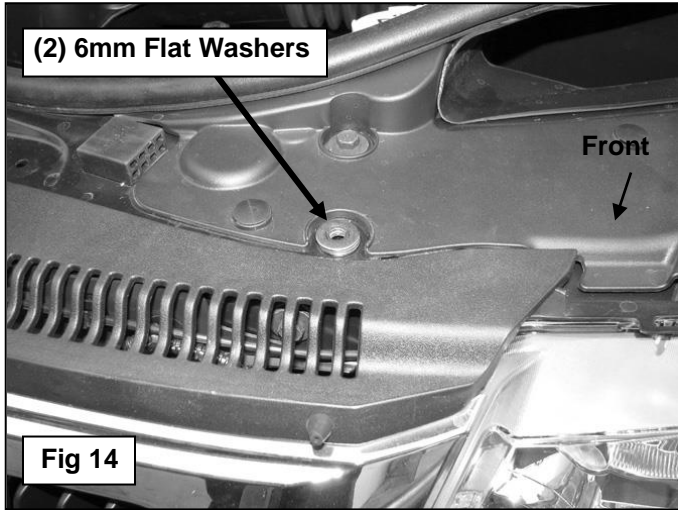

Fig 13

S/S MUODULAR GRILLE GUARD
FOR JEEP GRAND CHEROKEE 2011-20 Excl. SRT, EcoDiesel , Trail Hawk & Summit Models

Driver Side Installation Pictured



- 10mm x 30mm Button Head Bolt
- (2) 10mm x 20mm Small Flat Washers
- 10mm Nylon Lock Nut

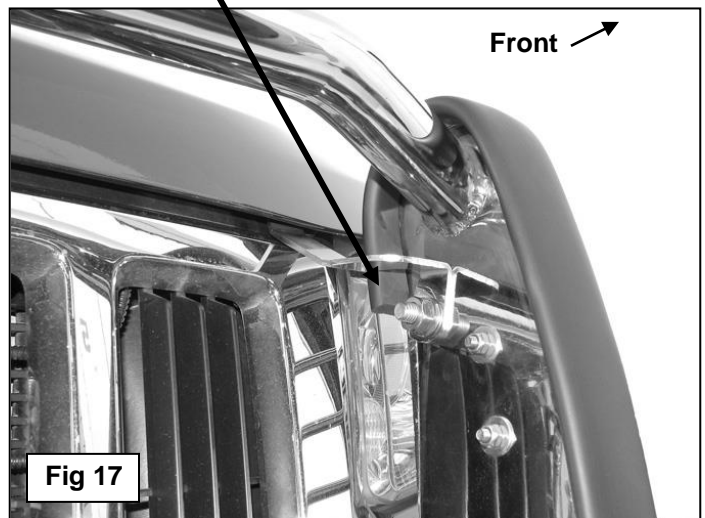

S/S MUODULAR GRILLE GUARD
FOR JEEP GRAND CHEROKEE 2011-20 Excl. SRT, EcoDiesel , Trail Hawk & Summit Models

Figure 1

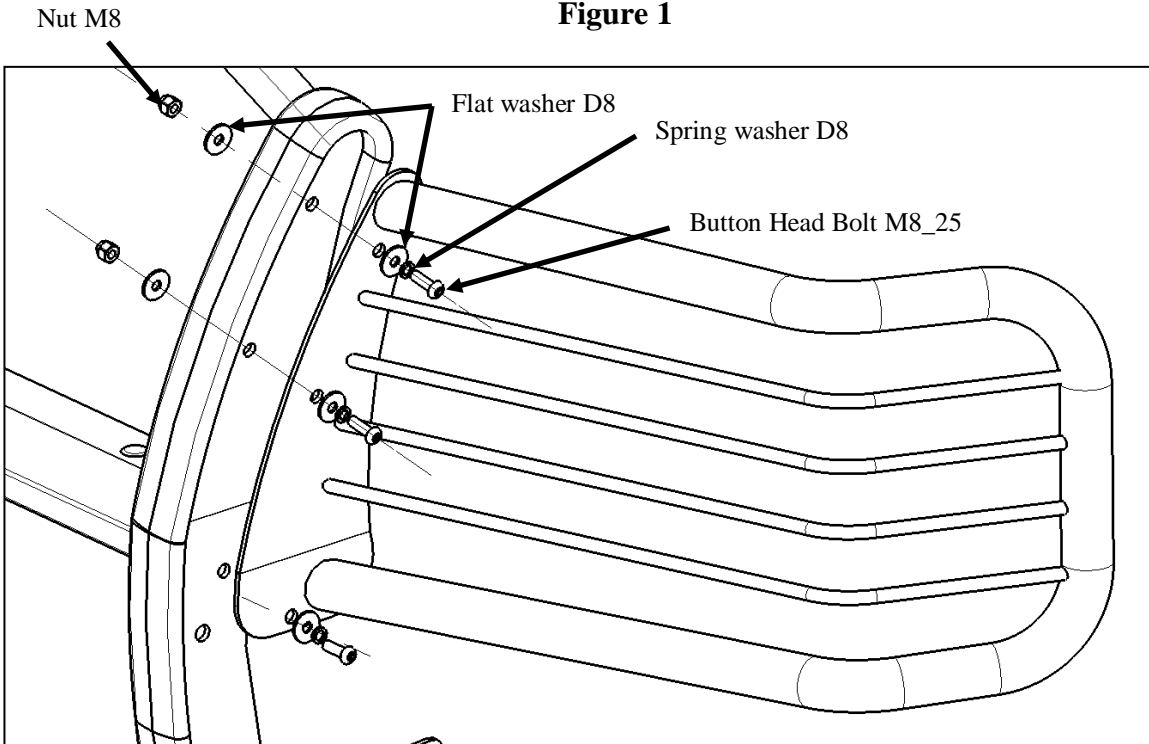

Figure 2

