



INSTALLATION INSTRUCTIONS

BLACK MODULAR GRILLE GUARD FOR JEEP LIBERTY 02-07

PART # 17EH26MA

Before Installation





- Please read the instruction completely for easy installation, which will also help you to avoid scratches or other potential damages to your appealing car.
- The information shown here is for reference only and may differ from the product that you receive, however the goods are fitted in the same way.

Care and Cleaning

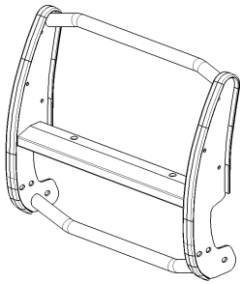
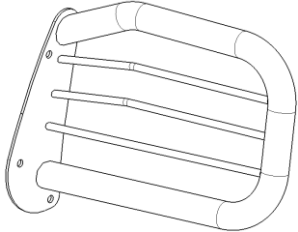
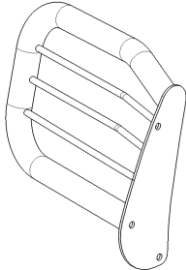
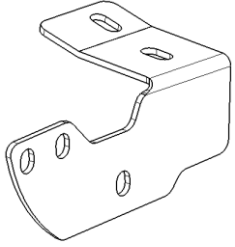
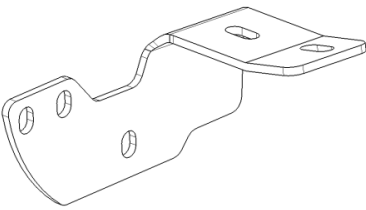
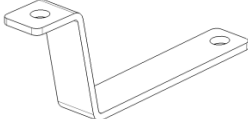
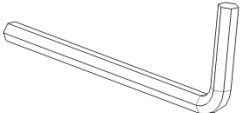
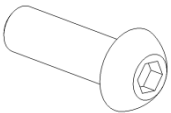
- Mild soap may be used also to clean the Product.
- Please periodically check and retighten all the hardware and clean the investment for a refresh look.

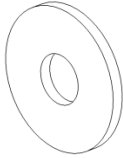
Parts list

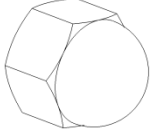
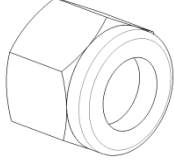
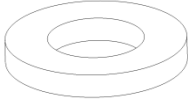
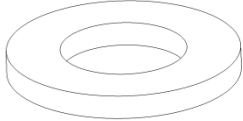
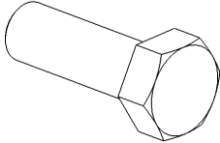
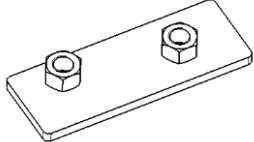
NO.	QTY	PICTURE	NO.	QTY	PICTURE
①	1	 Front Guard	②	1	 Left Brush Guard
③	1	 Right Brush Guard	④	1	 Left Bracket
⑤	1	 Left Bracket	⑥	1	 Connecting Bracket
⑦	1	 Allen Wrench S=5	⑧	6	 Button Head Bolt M8_25

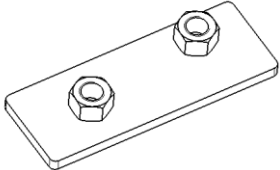
<p>⑨</p>	<p>6</p>	 <p>Flat Washer D8(8x24x2mm)</p>	<p>⑩</p>	<p>6</p>	 <p>Spring WasherD8</p>
<p>⑪</p>	<p>6</p>	 <p>Nut M8</p>	<p>⑫</p>	<p>6</p>	 <p>Lock Nut M12</p>
<p>⑬</p>	<p>2</p>	 <p>Flat Washer D6(6x12x1.6mm)</p>	<p>⑭</p>	<p>16</p>	 <p>Flat Washer D12(12x24x2.5mm)</p>
<p>⑮</p>	<p>10</p>	 <p>Hex Bolt M12_35</p>	<p>⑯</p>	<p>1</p>	 <p>Nut Plates (L)</p>
<p>⑰</p>	<p>1</p>	 <p>Hex bolt M6_20</p>	<p>⑱</p>	<p>1</p>	 <p>Lock Nut M6</p>
<p>⑲</p>	<p>1</p>	 <p>Nut Plates (R)</p>			

Installation Steps

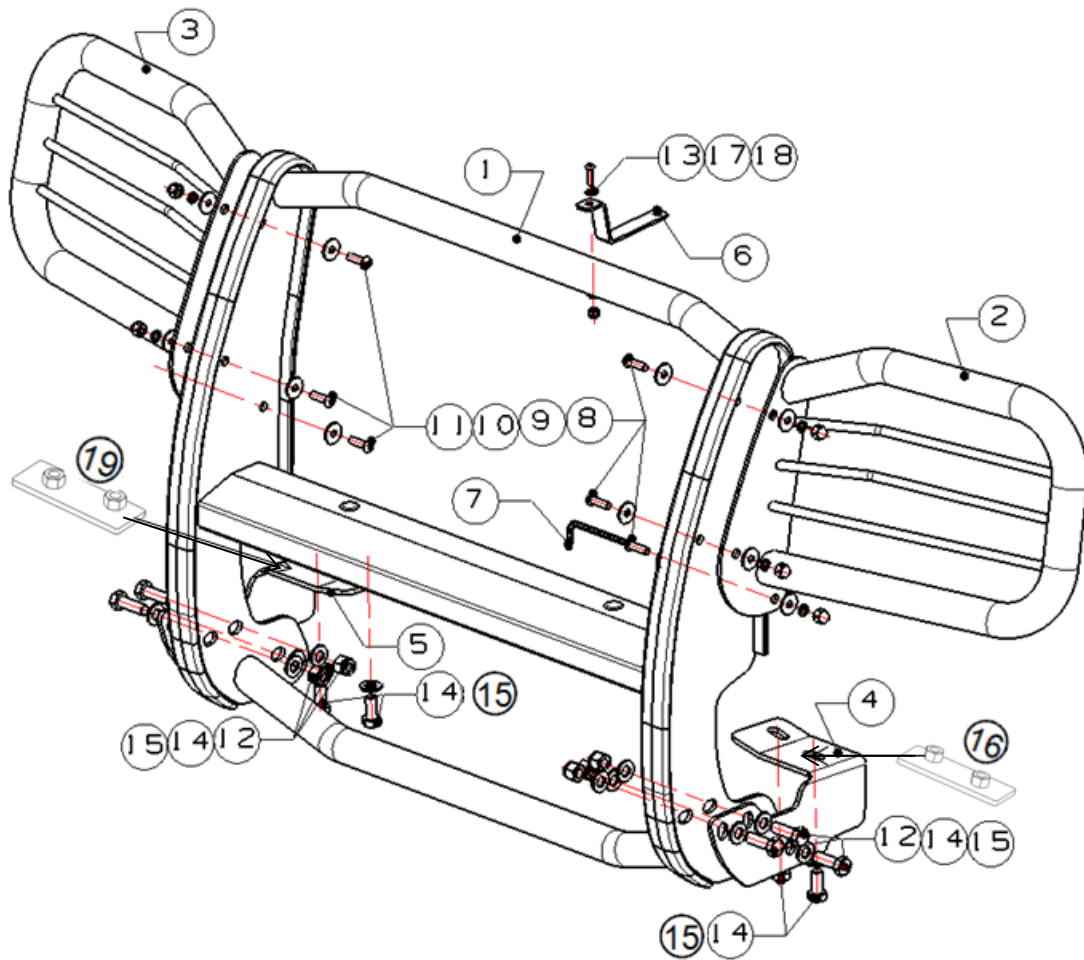

Step 1: Install left and right brush guard on the front guard.

Step 2: Install the left and right bracket and connecting brackets on the vehicle.

Step 3: Attach the Guard to the Support Brackets using the hardware listed. After checking for proper clearance and alignment of the Front Guard on the vehicle fully tighten all hardware.

NOTE

Any damages and losses caused by improper installation and application, goes beyond our quality warranty.