

ATLAS ROLL BAR TONNEAU WITH BRAKE LIGHT&BASKET FOR NISSAN FRONTIER 2022
(WITH TONNEAU COVER BASE)



INSTALLATION INSTRUCTIONS

**ATLAS ROLL BAR TONNEAU WITH BRAKE LIGHT&BASKET FOR
NISSAN FRONTIER 2022 (WITH TONNEAU COVER BASE)**

PART # ATR22

Before Installation

- Please read the instruction completely for easy installation, which will also help you to avoid scratches or other potential damages to your appealing car.
- The figures here are for reference only and may have differences with the actual product you received, however they share the same assembly way.







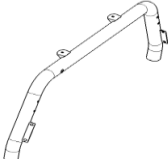
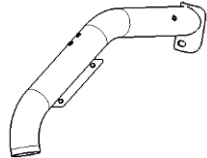
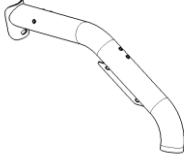
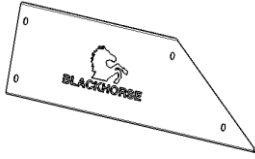
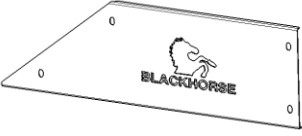
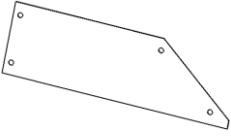
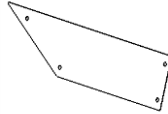
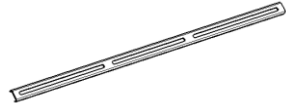



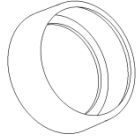

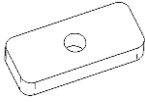



Care and Cleaning

- Mild soap may be used also to clean the Product.
- Please periodically check and retighten all the hardware and clean the investment for a refresh look.

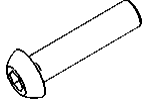



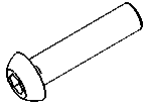

Parts list

NO.	QTY	NAME	NO.	QTY	NAME
MR ROLL BAR					
①	1	 Main tube 1	②	1	 Side tube-L
③	1	 Side tube-R	④	1	 Decoration plate-L
⑤	1	 Decoration plate-R	⑥	2	 Red decoration plate
⑦	2	 Decoration plate backboard	⑧	1	 Connecting plate

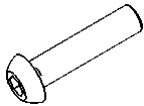

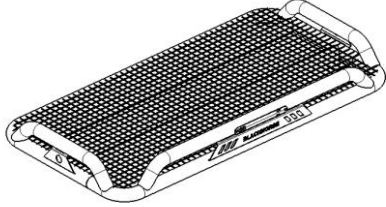
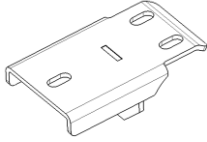
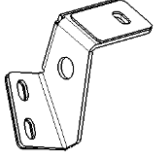
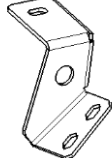



ATLAS ROLL BAR TONNEAU WITH BRAKE LIGHT&BASKET FOR NISSAN FRONTIER 2022
(WITH TONNEAU COVER BASE)

9	4	 Gum cover	10	2	 Rubber plug
11	2	 Block	12	5	 5.6mm*200mm 扎带
MR ROLL BAR STANDARD PARTS					
13	1	 Allen wrench S=4	14	1	 Allen wrench S=5
15	1	 Allen wrench S=6	16	1	 Allen wrench S=8
17	8	 Hex nut M6	18	8	 Flat washer D6
19	8	 Button head allen bolts M6_20	20	2	 Button head allen bolts M8*30
21	4	 Flat washer D8	22	2	 Hex nut M8
23	2	 Spring washer D8	24	2	 Flat washer D10
25	2	 Button head allen bolts M10_25	26	2	 Spring washer D10

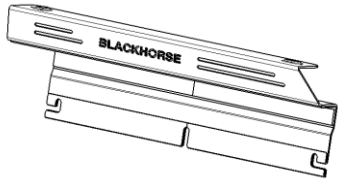
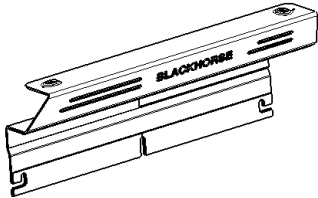
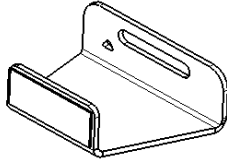
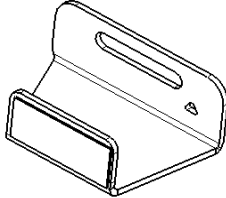
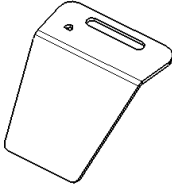
**ATLAS ROLL BAR TONNEAU WITH BRAKE LIGHT&BASKET FOR NISSAN FRONTIER 2022
(WITH TONNEAU COVER BASE)**

27	2	 Button head allen bolts M12_40	28	2	 Flat washer D12
MR LUGGAGE FRMAE					
29	1	 Luggage frame (with LED light)	30	2	 Connect bracket 1
31	1	 Connect bracket 2-L	32	1	 Connect bracket 2-R
33	5	 5.6mm*200mm strapping			
MR LUGGAGE FRMAE STANDARD PARTS					
34	4	 Hex nut M8	35	14	 Flat washer D8
36	4	 Hex bolt M8*25			
MOUNTING BASE					

ATLAS ROLL BAR TONNEAU WITH BRAKE LIGHT & BASKET FOR NISSAN FRONTIER 2022
(WITH TONNEAU COVER BASE)

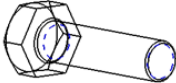
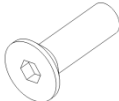
37	1	 L-bracket	38	1	 R-bracket
39	1	 Front end cover (L)	40	1	 Front end cover (R)
41	1	 Rear end cover (L)	42	1	 Rear end cover (R)
43	6	 Nut block			
MOUNTING BASE STANDARD PARTS					
44	1	 Allen wrench S=4	45	1	 Allen wrench S=8
46	6	 Flat washer D10	47	6	 Spring washer D10
48	6	 Hex bolt M10*25	49	4	 Flat head allen bolts M12_40

ATLAS ROLL BAR TONNEAU WITH BRAKE LIGHT & BASKET FOR NISSAN FRONTIER 2022
(WITH TONNEAU COVER BASE)

50	4	 Button head allen bolts M6_20			
----	---	--	--	--	--

Installation Steps

Step1: Check all the contents are available in accordance with the above list. Install the roll bar together as picture shown.

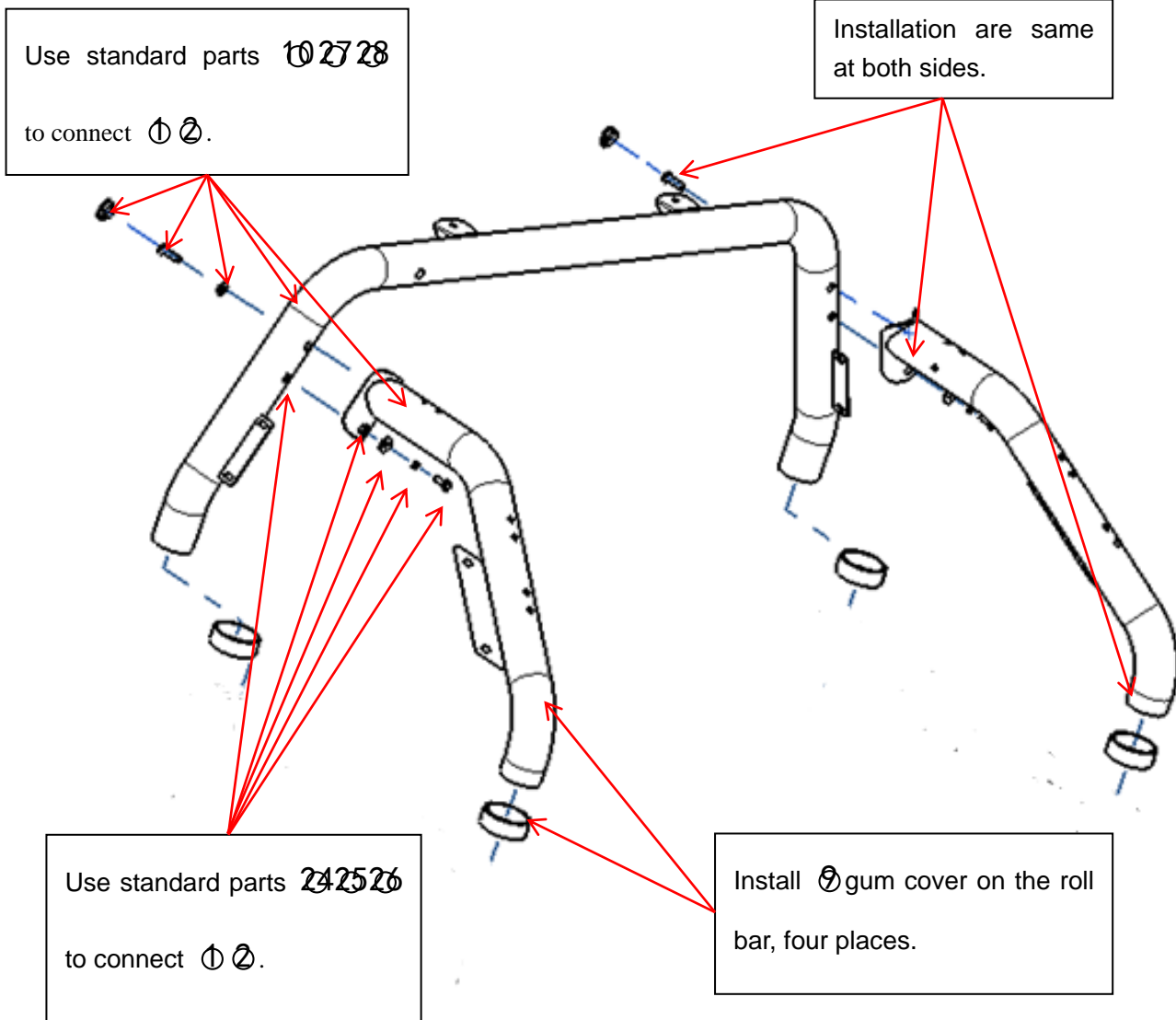

ATLAS ROLL BAR TONNEAU WITH BRAKE LIGHT&BASKET FOR NISSAN FRONTIER 2022
(WITH TONNEAU COVER BASE)

Step2: Install the roll bar and luggage frame as following picture.

Use standard parts 20 21 22 23 to connect 8 11 on the tubes. 2 places.

Use standard parts 34 35 36 to connect 29 on the tubes. 4 places.

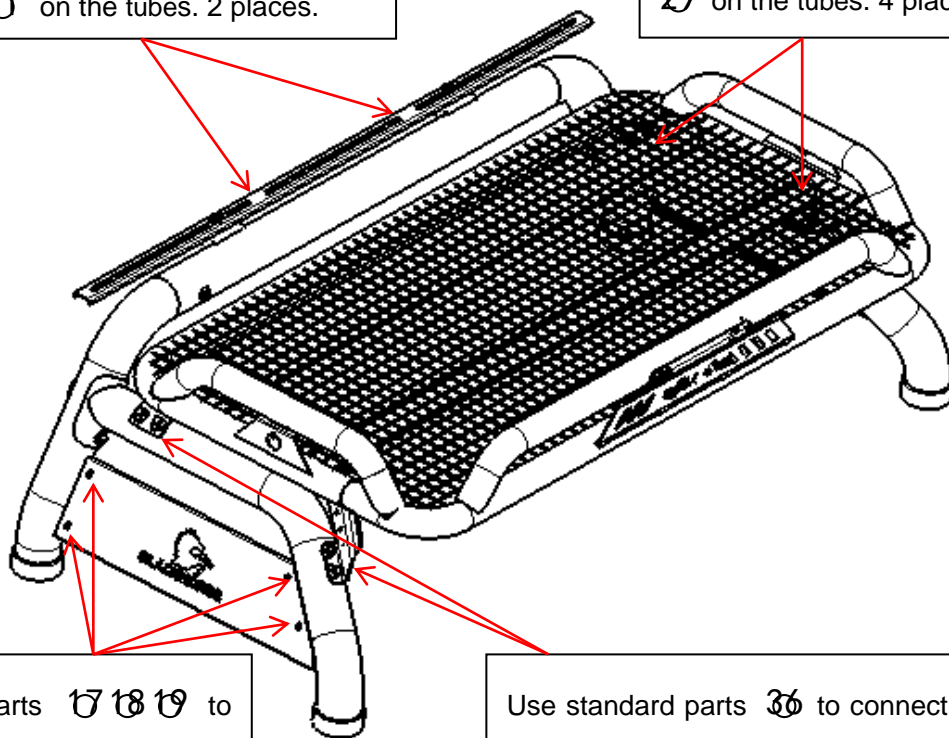

Use standard parts 17 18 19 to connect 4 6 7 on the tubes. 8 places.

Use standard parts 36 to connect 30 31 32 on the tubes. 8 places.

Step3: Install the roll bar and mounting base as picture.

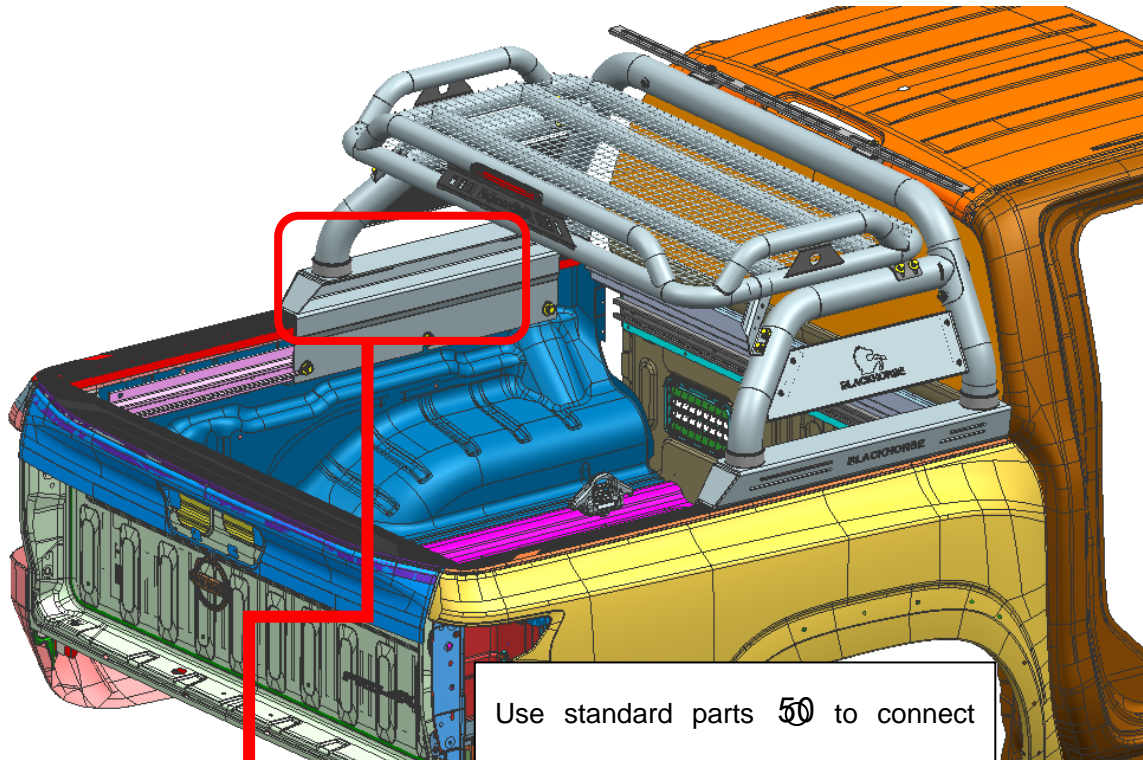

Use standard parts 50 to connect
3941. 4 places.

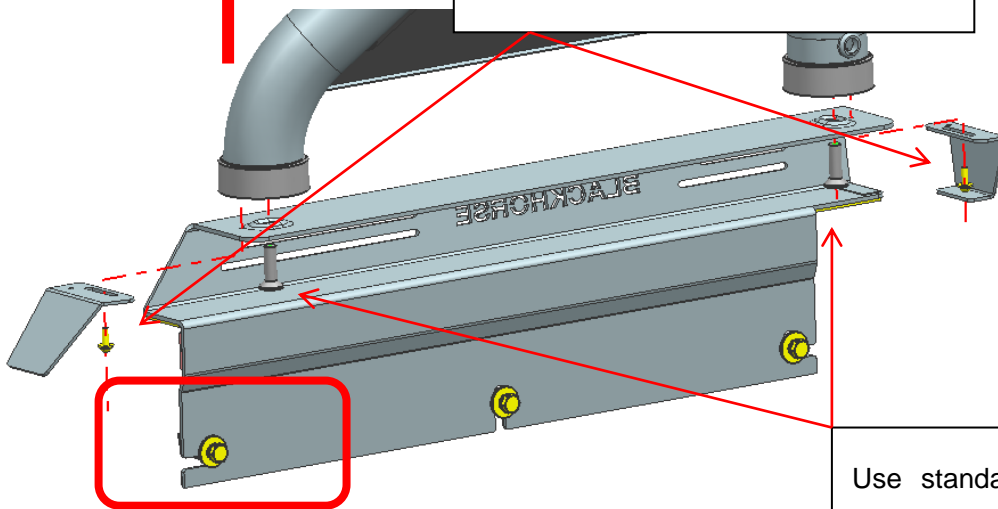

Use standard parts 49 to connect
37 bracket and roll bar. 2 places.

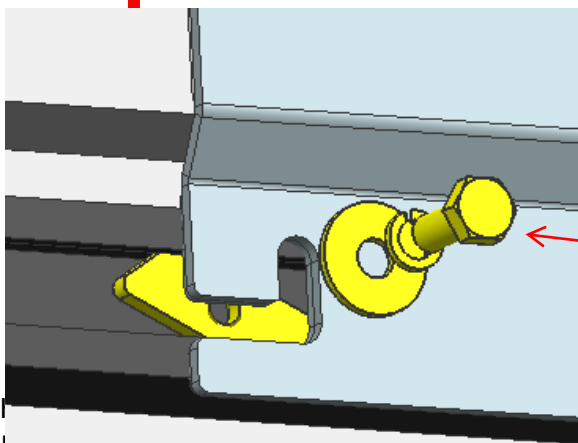

Use standard parts 46 47 48 to connect
37 bracket and roll bar. 6 places.

ATLAS ROLL BAR TONNEAU WITH BRAKE LIGHT&BASKET FOR NISSAN FRONTIER 2022
(WITH TONNEAU COVER BASE)

Step4: Remove the front and end cover of the support seat. Put the assembled soft tri-fold into the support seat according to the chute, tighten all the standard parts.

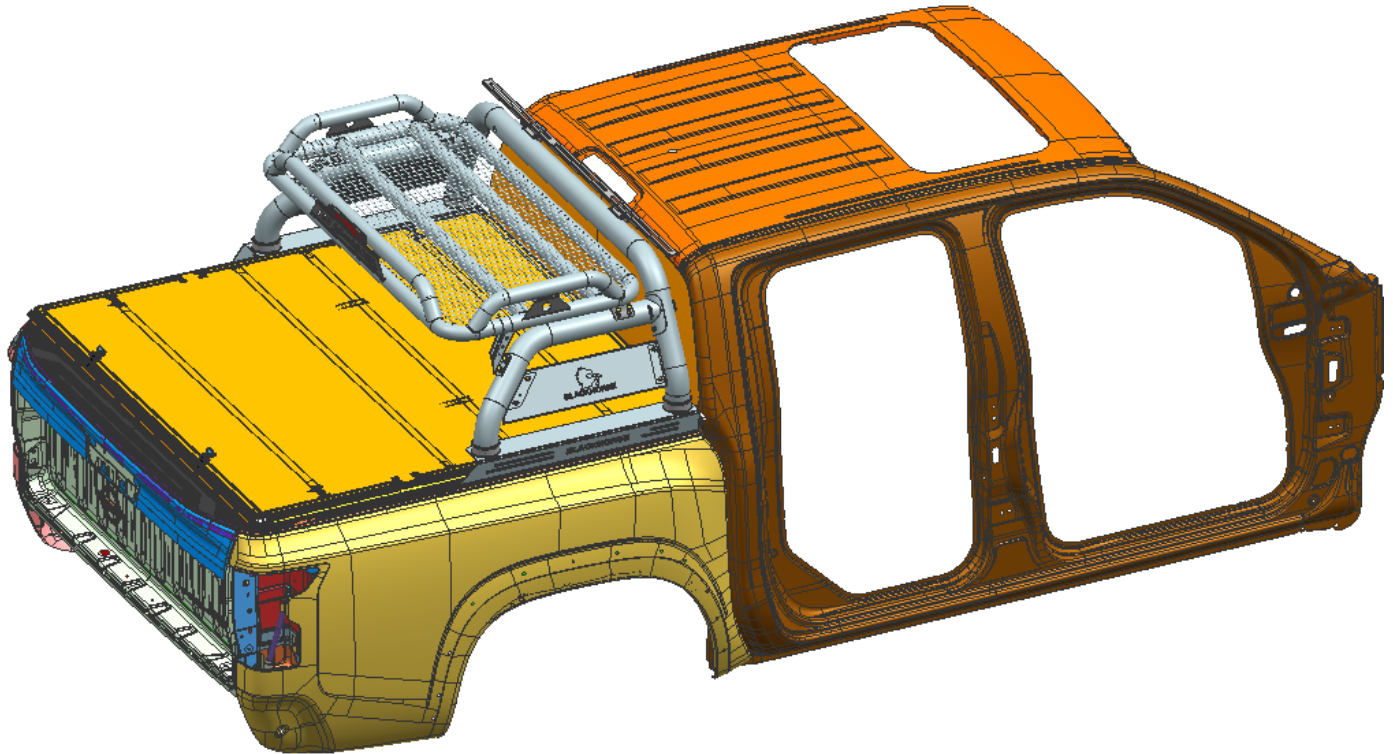

NOTE

Any damages and losses caused by improper installation and application, goes beyond our quality warranty.