















# INSTALLATION INSTRUCTION

ITEM NO: BBDG700-SP

## ATTENTION

1. Please read this installation instruction before installing this part. When install it, please pay attention to protecting your vehicles.
2. When you use it, please check this parts at a fix time-lapse, such as one month or two month.

## PARTS LIST

No	Name	Photo	Qty	Remarks	No	Name	Photo	Qty	Remarks
1	Grille Guard		1		7	Lock Washer		4	M10
2	Mount Bracket		2	Lateral symmetry	8	Bolt		2	M10X30
3	"T" Bolt		2	M10X30 (55X16X4.5)	9	Bolt		4	M12X30
4	Plastic Piece		2	M10	10	Lock Washer		4	M12
5	Hex Nut		2	M10	11	Hex Nut		4	M12
6	Flat washer		4	M10 (Φ 10.5* Φ 20*12.0)	12	Flat washer		8	M12 (Φ 12.5X Φ 30X12.0)

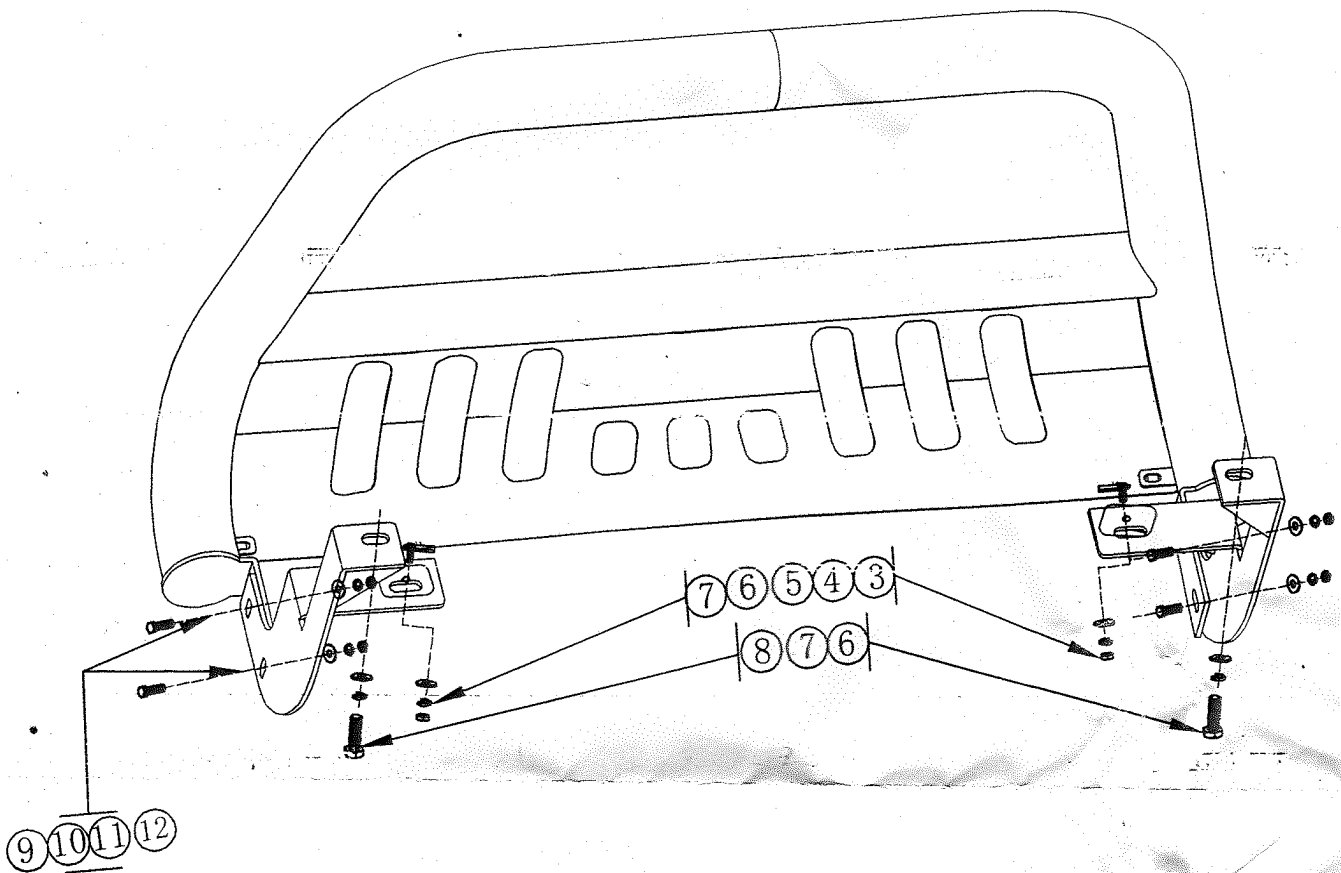

- STEP 1: Check the parts in the box carefully if match above list.
- STEP 2: Pls prepare the tools for installation, follow as: 14-17, 17-19 wrench.
- STEP 3: Install the mount bracket on the girder of the car, and tighten it with M10X30 "T" Bolt with bread.
- STEP 4: Install the Grille Guard on the mount bracket, and tighten it with M12X30 bolt.
- STEP 5: Installation is finished.