



**INSTALLATION INSTRUCTIONS**  
**CLASSIC ROLL BAR TONNEAU WITH BRAKE LIGHT FOR**  
**NISSAN FRONTIER 2022-2023 (WITH TONNEAU COVER BASE)**  
**PART # RBB22**





## Before Installation





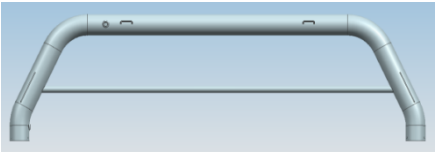

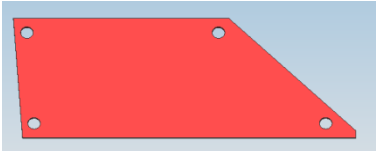

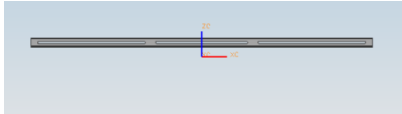
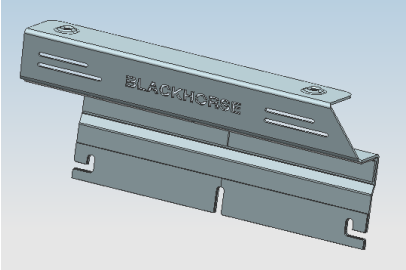
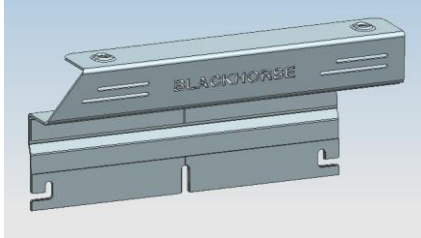
- Please read the instruction completely for easy installation, which will also help you to avoid scratches or other potential damages to your appealing car.
- The information shown here is for reference only and may differ from the product that you receive, however the goods are fitted in the same way.

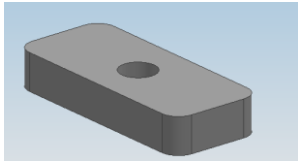
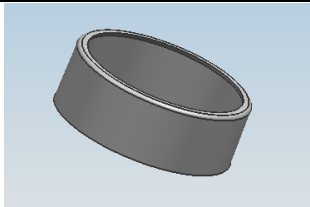
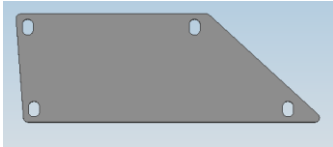
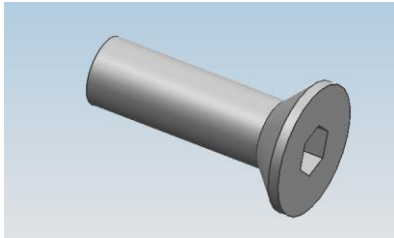
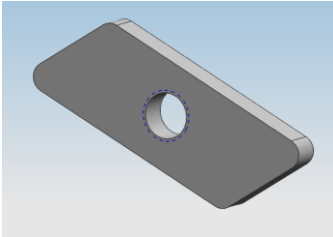
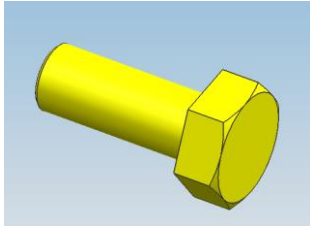
## Care and Cleaning

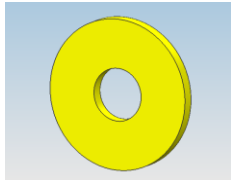
- Mild soap may be used also to clean the Product.
- Please periodically check and retighten all the hardware and clean the investment for a refresh look.

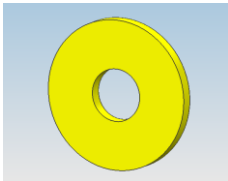
## Parts list

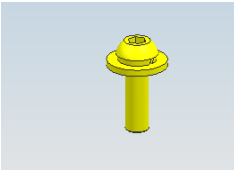
NO.	QTY	PICTURE	NO.	QTY	PICTURE
①	1	 Pipe 1	②	1	 Pipe 2
③	2	 Red decoration plate	④	1	 Decoration plate-L
⑤	1	 Decoration plate-R	⑥	1	 Connecting plate (FOR LED LIGHT INSTALLATION)
⑦	1	 L bracket	⑧	1	 R bracket

<p>⑨</p>	<p>2</p>	 <p>Block</p>	<p>⑩</p>	<p>4</p>	 <p>Gum cover</p>
<p>⑪</p>	<p>2</p>	 <p>Decoration plate backboard</p>	<p>⑫</p>	<p>4</p>	 <p>Button head allen bolts M12_40</p>
<p>⑬</p>	<p>6</p>	 <p>Nut block</p>	<p>⑭</p>	<p>6</p>	 <p>Hex bolt M10_25</p>
<p>⑮</p>	<p>6</p>	 <p>Lock washer D10</p>	<p>⑯</p>	<p>6</p>	 <p>Flat washer D10</p>
<p>⑰</p>	<p>2</p>	 <p>Lock washer D8</p>	<p>⑱</p>	<p>2</p>	 <p>Hex socket button head screw M8_40</p>
<p>⑲</p>	<p>4</p>	 <p>Flat washer D8</p>	<p>⑳</p>	<p>2</p>	 <p>Hex nuts M8</p>
<p>㉑</p>	<p>8</p>	 <p>Assembly bolt M6</p>	<p>㉒</p>	<p>8</p>	 <p>Flat washer D6</p>

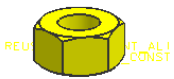
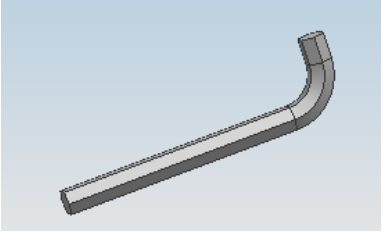
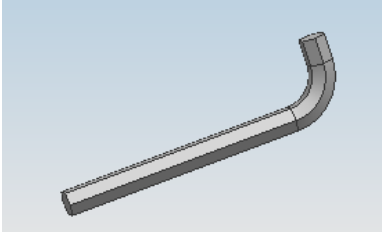
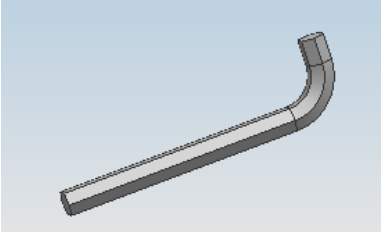
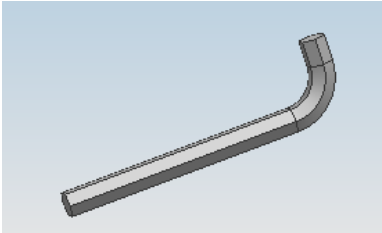
<p>②③</p>	<p>8</p>	 <p>Hex nuts M6</p>	<p>②④</p>	<p>1</p>	 <p>Allen wrench S=2.5</p>
<p>②⑤</p>	<p>1</p>	 <p>Allen wrench S=5</p>	<p>②⑥</p>	<p>1</p>	 <p>Allen wrench S=4</p>
<p>②⑦</p>	<p>1</p>	 <p>Allen wrench S=8</p>			

### Installation Steps

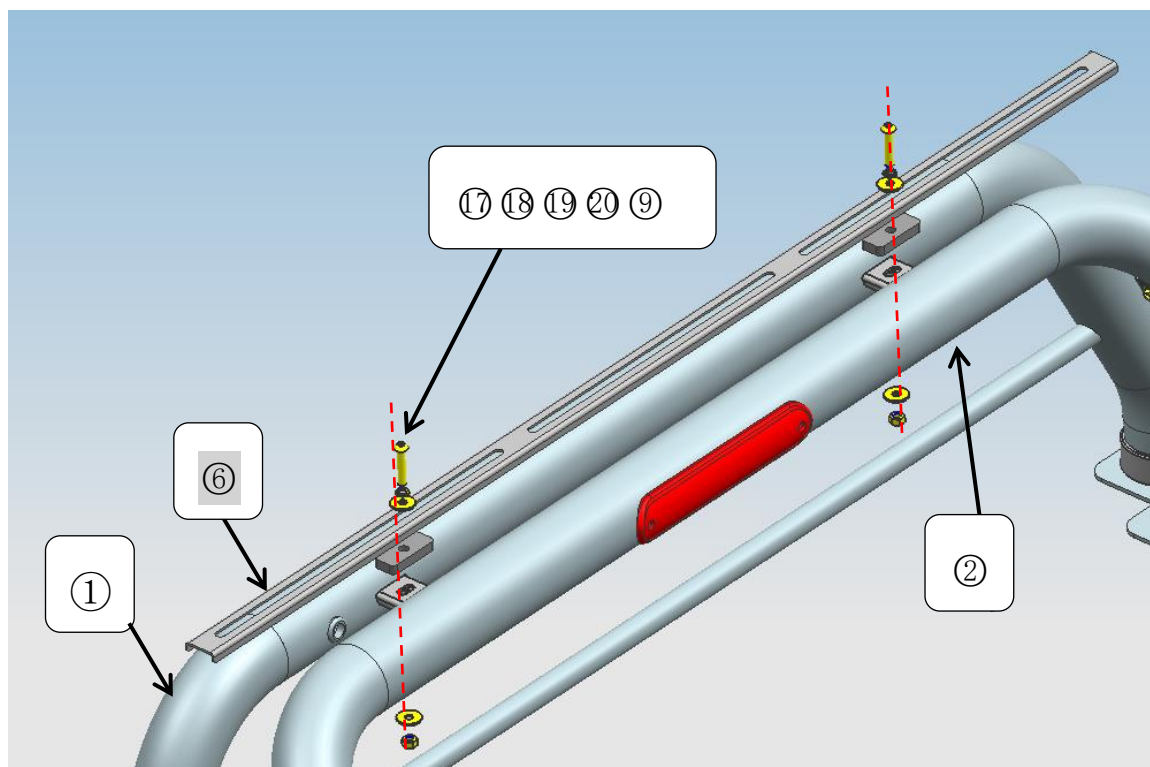

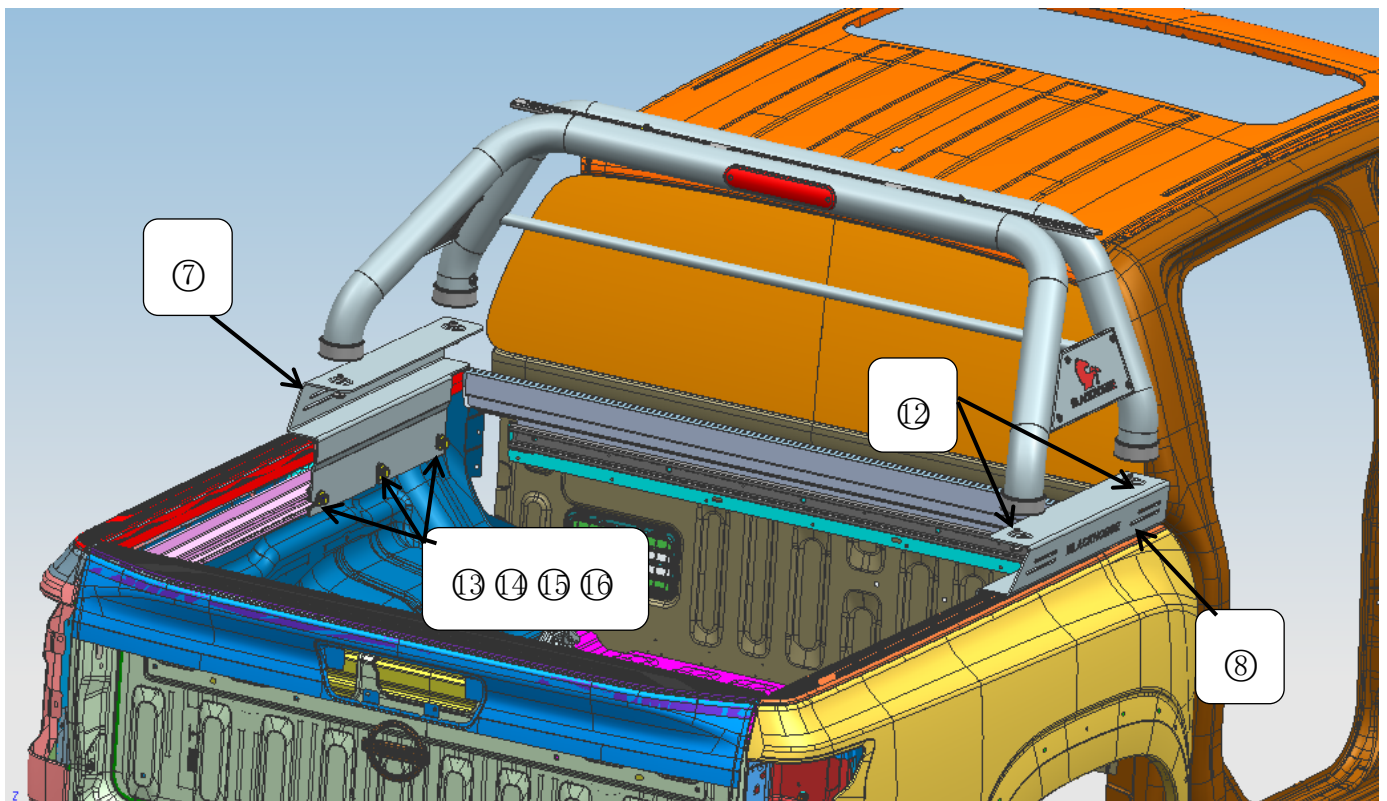
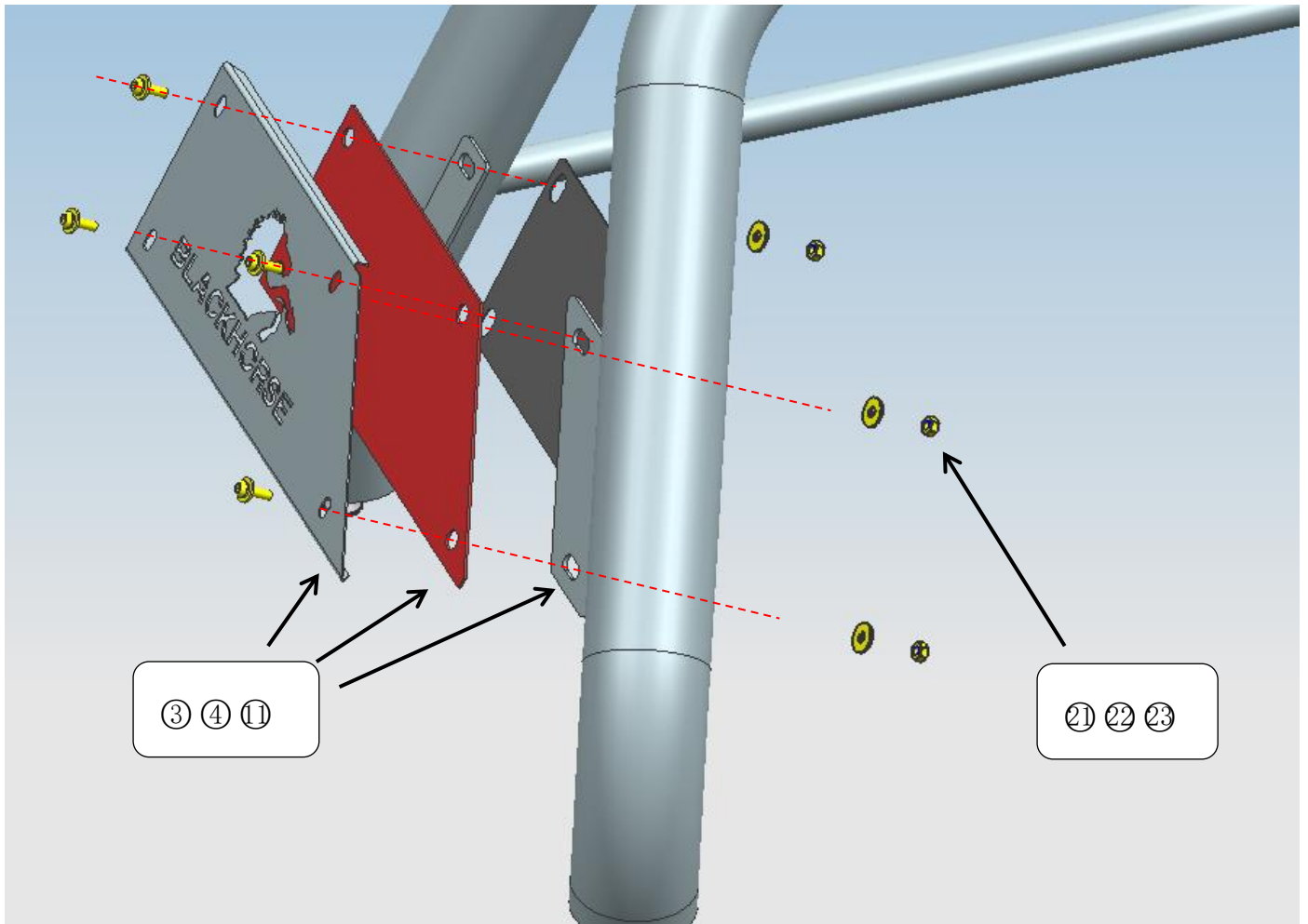

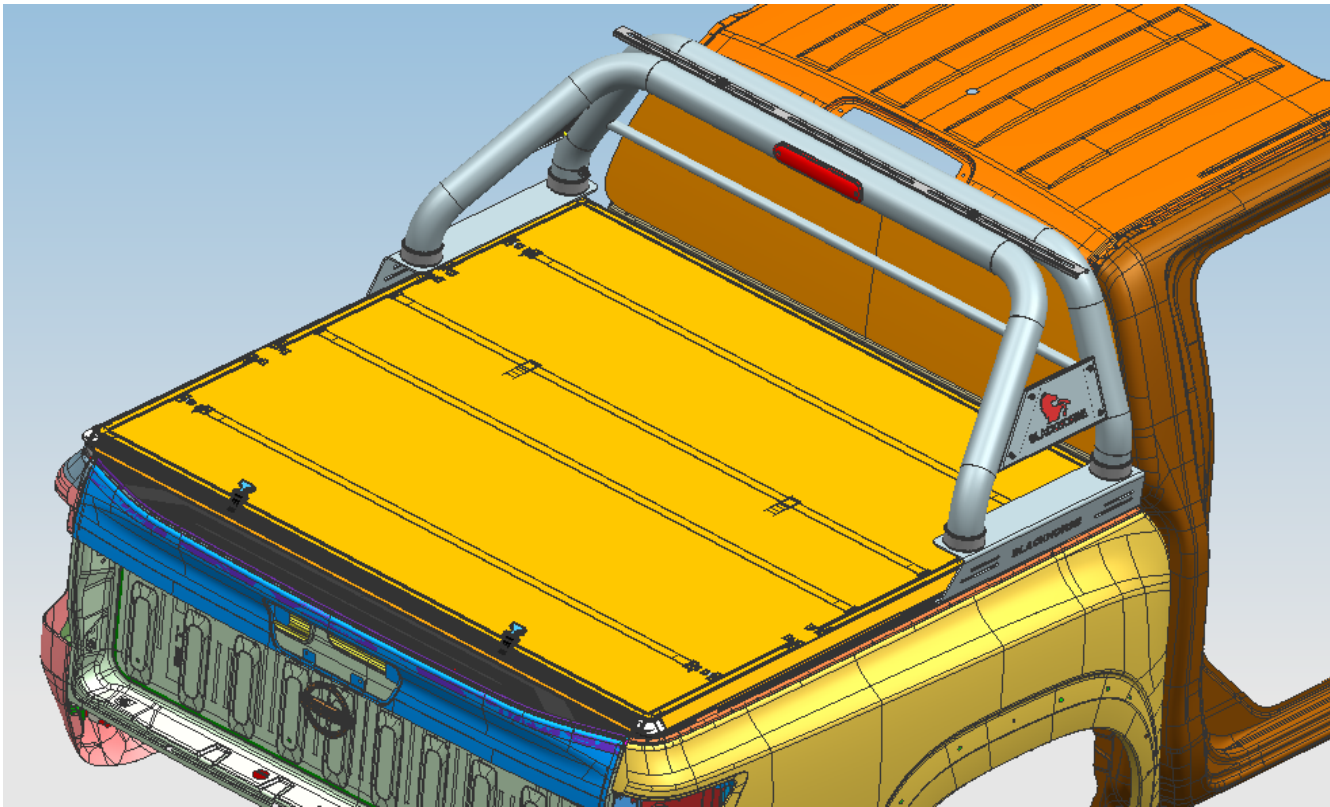

Installed as below show:

Step 1: Check all the contents are available in accordance with the above list.

Step 2: Install ①②⑥⑨ together with parts ⑰⑱⑲⑳ as shown.

Step 3: Install ③④⑪ decoration plate together with parts ㉑㉒㉓ as shown.

Step 4: Prepared the SA roll bar, bracket ⑦ and bracket ⑧, then use Allen wrench S=8 and Flat head allen bolts M12\*40 ⑫ to connect roll bar and brackets without locking them.

Step 5: Use accessories ⑬⑭⑮⑯ to fasten roll bar and brackets on the truck at appropriate positions. Then fasten with Flat head allen bolts M12\*40 ⑫.

Step 6: Put the assembled soft tri-fold into the support seat according to the chute, tighten all the standard parts.

Step 7: Installation is finished.

## NOTE

Any damages and losses caused by improper installation and application, goes beyond our quality warranty.