



INSTALLATION INSTRUCTIONS

BLACK ATLAS ROLL BAR FOR 99-20 FORD F250/F350/F450 WITH

CARGO BASKET

PART # RB-BA15B







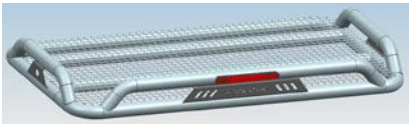

Before Installation

- Please read the instruction completely for easy installation, which will also help you to avoid scratches or other potential damages to your appealing car.
- The figures here are for reference only and may have differences with the actual product you received, however they share the same assembly way.

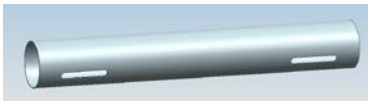









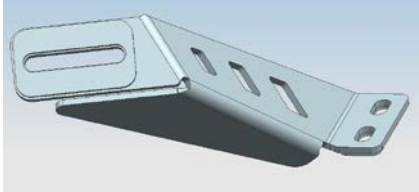

Care and Cleaning

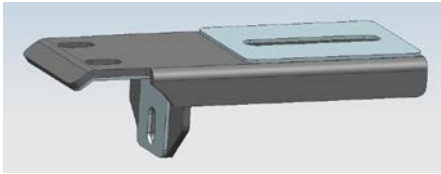
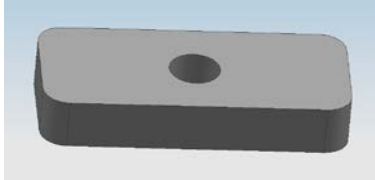
- Mild soap may be used also to clean the Product.
- Please periodically check and retighten all the hardware and clean the investment for a refresh look.

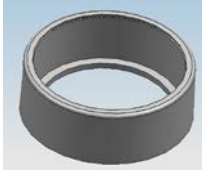

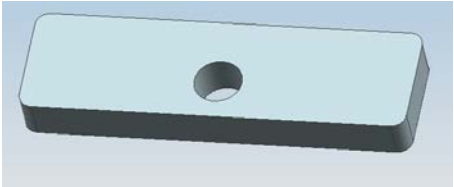

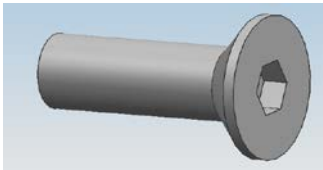
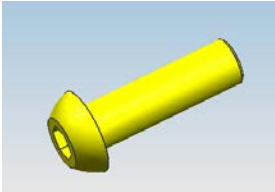
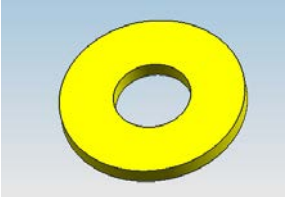
Parts list

NO.	QTY	NAME	NO.	QTY	NAME
①	1	 Luggage frame	②	1	 Main tube-L
③	1	 Main tube-R	④	1	 Main tube-Middle
⑤	1	 Side tube-L	⑥	1	 Side tube-R
⑦	1	 Decoration plate-L	⑧	1	 Decoration plate-R
⑨	1	 Red decoration plate-L	⑩	1	 Red decoration plate-R

BLACK ATLAS ROLL BAR FOR 99-20 FORD F250/F350/F450 WITH CARGO BASKET

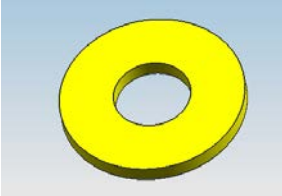
<p>⑪</p>	<p>2</p>	 <p>Decoration plate backboard</p>	<p>⑫</p>	<p>1</p>	 <p>Connecting plate</p>
<p>⑬</p>	<p>1</p>	 <p>Connect bracket 2-L</p>	<p>⑭</p>	<p>1</p>	 <p>Connect bracket 2-R</p>
<p>⑮</p>	<p>2</p>	 <p>Connect bracket</p>	<p>⑯</p>	<p>2</p>	 <p>Block</p>
<p>⑰</p>	<p>1</p>	 <p>Support bracket-L</p>	<p>⑱</p>	<p>1</p>	 <p>Support bracket-R</p>
<p>⑲</p>	<p>4</p>	 <p>Gum cover</p>	<p>⑳</p>	<p>2</p>	 <p>Rubber plug</p>
<p>㉑</p>	<p>8</p>	 <p>Nut block M8 (20*55*6)</p>	<p>㉒</p>	<p>5</p>	 <p>6mm*200mm Cable ties (black)</p>
<p>㉓</p>	<p>4</p>	 <p>Countersunk head allen bolt M12_40</p>	<p>㉔</p>	<p>2</p>	 <p>Button head allen bolt M12_40</p>
<p>㉕</p>	<p>2</p>	 <p>Flat washer D12(12x24x2.5mm)</p>	<p>㉖</p>	<p>2</p>	 <p>Hex bolt M10_25</p>

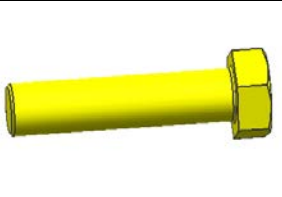
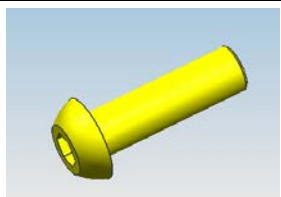
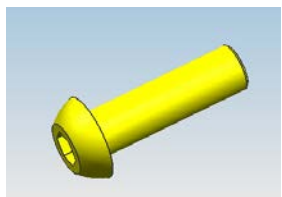
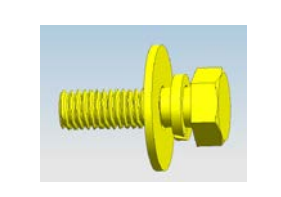
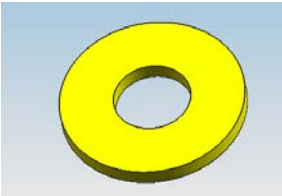
BLACK ATLAS ROLL BAR FOR 99-20 FORD F250/F350/F450 WITH CARGO BASKET

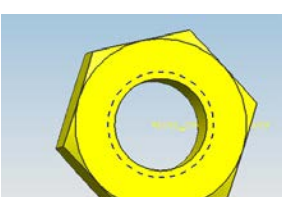
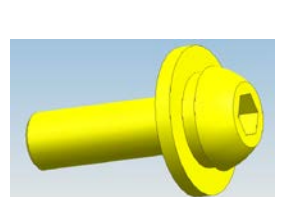
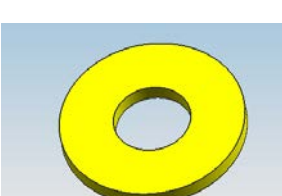
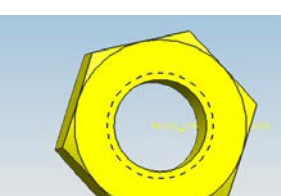
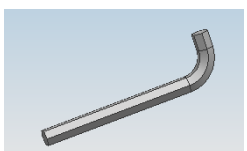
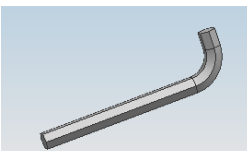
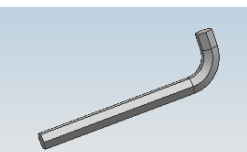
<p>②⑦</p>	<p>2</p>	 <p>Flat washer D10(10x30x2.5mm)</p>	<p>②⑧</p>	<p>2</p>	 <p>Lock washer D10</p>
<p>②⑨</p>	<p>8</p>	 <p>Hex bolt M8_40</p>	<p>③⑩</p>	<p>2</p>	 <p>Button head allen bolt M8_30</p>
<p>③①</p>	<p>2</p>	 <p>Button head allen bolt M8_25</p>	<p>③②</p>	<p>14</p>	 <p>Assembly bolt M8_25</p>
<p>③③</p>	<p>18</p>	 <p>Flat washer D8(8x24x2mm)</p>	<p>③④</p>	<p>12</p>	 <p>Lock washer D8</p>
<p>③⑤</p>	<p>6</p>	 <p>Hex nut M8</p>	<p>③⑥</p>	<p>8</p>	 <p>Assembly bolt M6_20</p>
<p>③⑦</p>	<p>8</p>	 <p>Flat washer D6(6x18x1.6mm)</p>	<p>③⑧</p>	<p>8</p>	 <p>Hex nut M6</p>
<p>③⑨</p>	<p>1</p>	 <p>Allen wrench S=8</p>	<p>④⑩</p>	<p>1</p>	 <p>Allen wrench S=5</p>
<p>④①</p>	<p>1</p>	 <p>Allen wrench S=4</p>			

Installation Steps

Step1: Assemble tubes with standard parts. Lock all the standard parts after adjust the position.

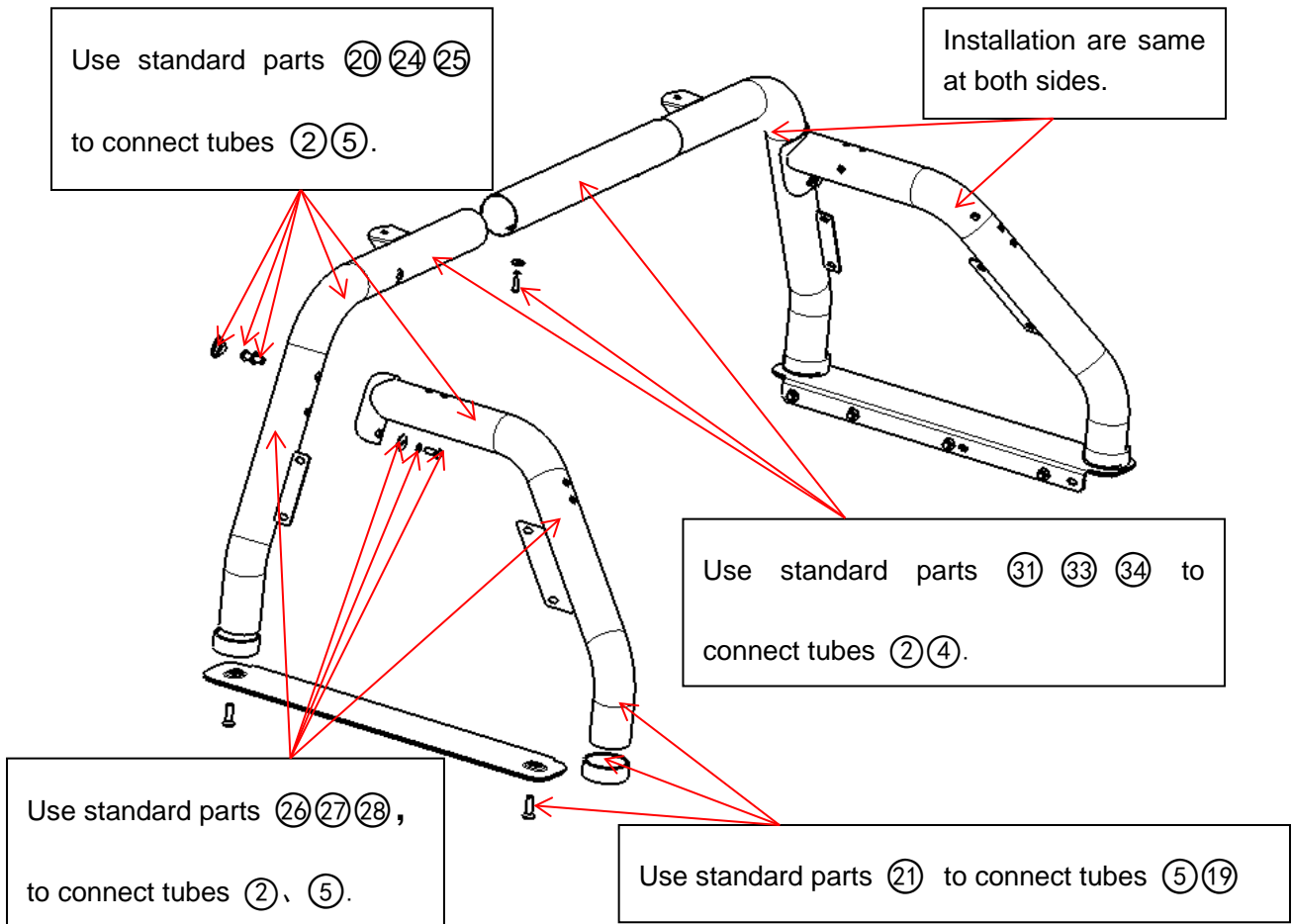

BLACK ATLAS ROLL BAR FOR 99-20 FORD F250/F350/F450 WITH CARGO BASKET

Step 2: Assemble Luggage frame and tubes with standard parts. Lock all the standard parts after adjust the position.

Use standard parts ③① ③③ ③④ ③⑤ to connect Connecting plate ⑫ ⑬, two places.

Use standard parts ③② ③③ ③⑤ to connect luggage frame ①, four places.

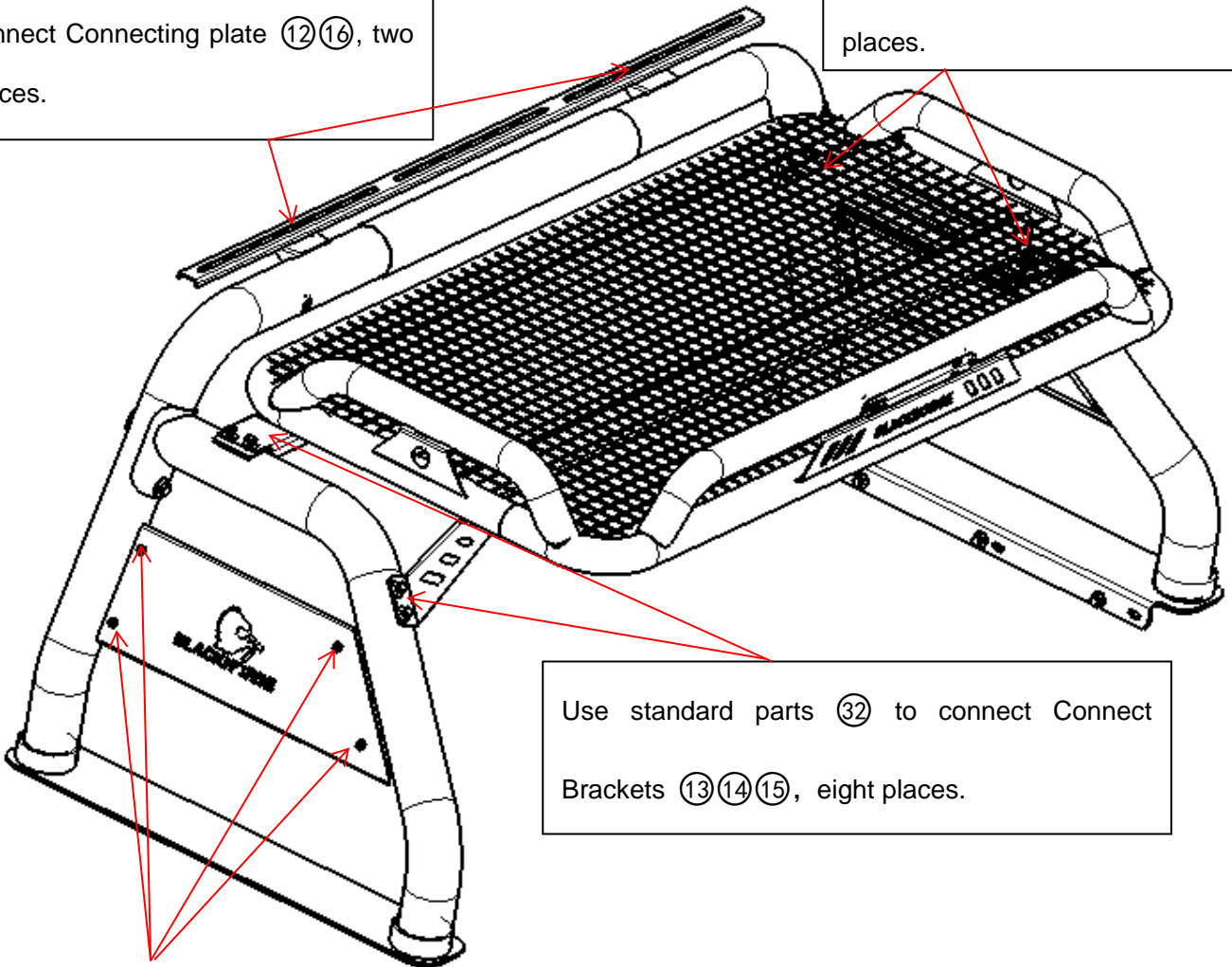

Use standard parts ③② to connect Connect Brackets ⑬ ⑭ ⑮, eight places.

Use standard parts ③⑥ ③⑦ ③⑧ to connect decoration plates ⑦ ⑨ ⑪, eight places.

BLACK ATLAS ROLL BAR FOR 99-20 FORD F250/F350/F450 WITH CARGO BASKET

Step 3: Put roll bar on the truck in an appropriate place. And use pen to mark the holes. 4 places in each part, 8 places total. Remove the roll bar then drill the size of $\Phi 12$ holes. Put the roll bar back and use standard (21) (29) (33) (34) to fasten.

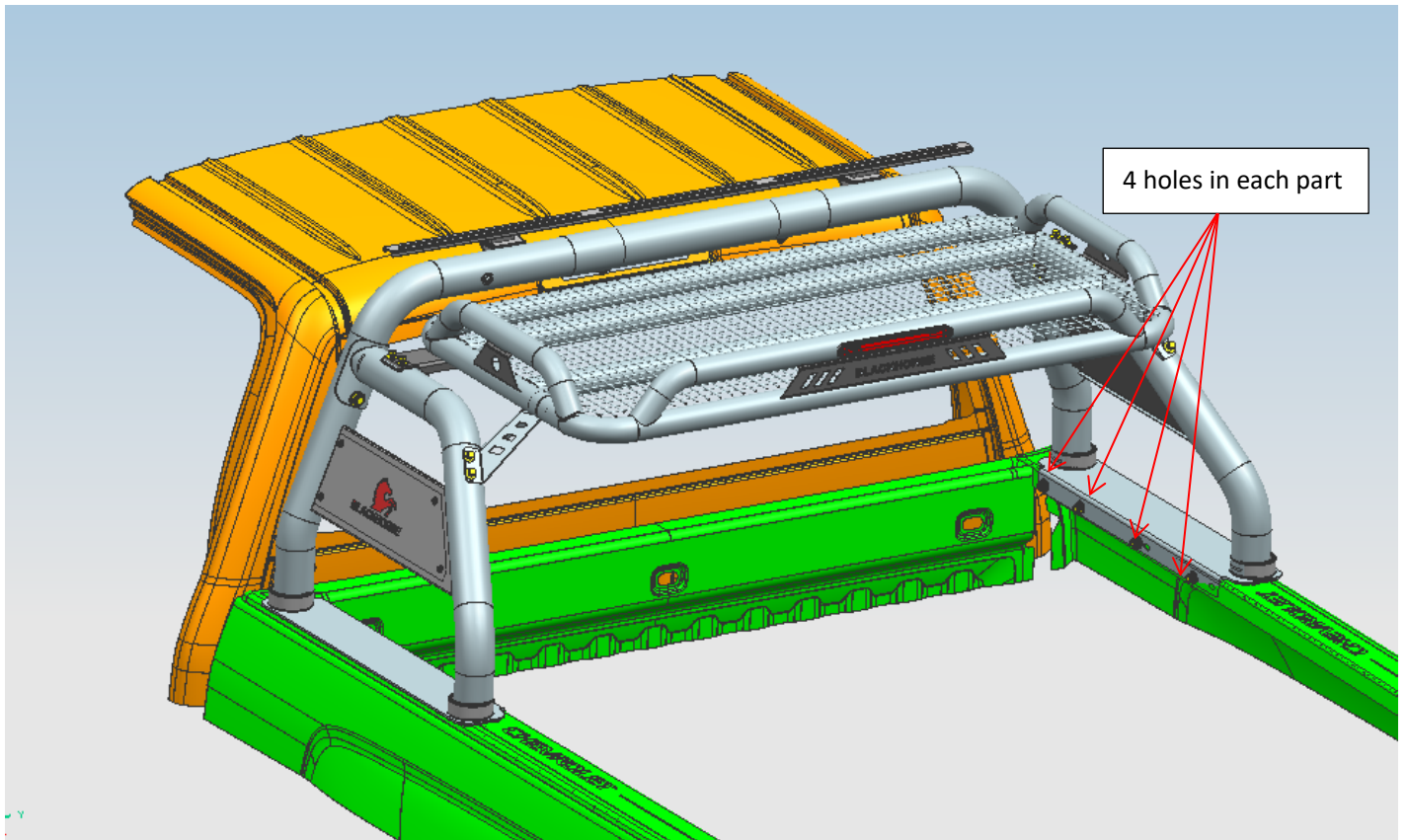

NOTE

Any damages and losses caused by improper installation and application, goes beyond our quality warranty.