

BLACK MODULAR GRILLE GUARD FOR 22-26 CHEVY SILVERADO 1500 (Incl. Diesel models with DEF tanks & Excl. 2022 1500 LTD and 22-24 models with super cruise system)



TEL: 1-866-XANATOS

INSTALLATION INSTRUCTIONS

**BLACK MODULAR GRILLE GUARD FOR 22-26 CHEVY SILVERADO
1500 (Incl. Diesel models with DEF tanks & Excl. 2022 1500 LTD and 22-24
models with super cruise system)**

PART # 17GT22MA

PROTECTED BY ONE OR MORE PATENT





Before Installation

- Please read the instruction completely for easy installation, which will also help you to avoid scratches or other potential damages to your appealing car.
- The figures here are for reference only and may have differences with the actual product you received, however they share the same assembly way.



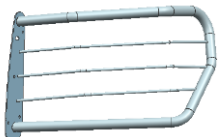
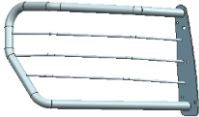
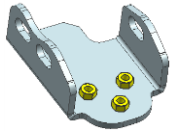
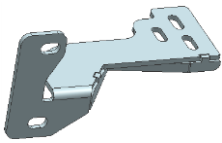

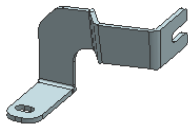
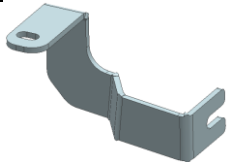

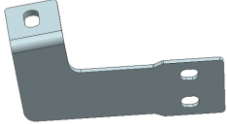
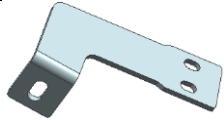



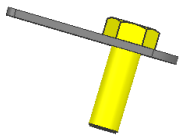
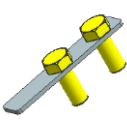

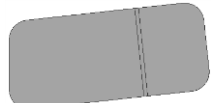
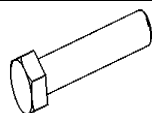
Care and Cleaning

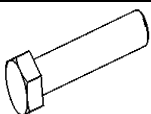
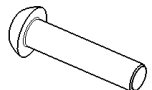
- Mild soap may be used also to clean the Product.
- Please periodically check and retighten all the hardware and clean the investment for a refresh look.

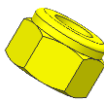
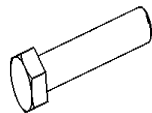
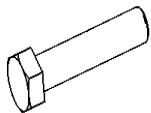
Parts list

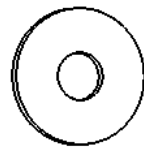
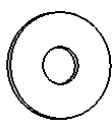
NO.	QTY	NAME	NO.	QTY	NAME
①	1	 Middle Guard	②	1	 Left Brush Guard
③	1	 Right Brush Guard	④	2	 Mounting Bracket
⑤	1	 Driver/Left Lower Mounting Bracket	⑥	1	 Passenger/Right Lower Mounting Bracket
⑦	1	 Driver/Left Support Bracket	⑧	1	 Passenger/Right Support Bracket
⑨	2	 Top Support Bracket	⑩	2	 Top Support Bracket Adhesive tape
⑪	1	 Driver/Left Upper Support Bracket	⑫	1	 Passenger/Right Upper Support Bracket

BLACK MODULAR GRILLE GUARD FOR 22-26 CHEVY SILVERADO 1500 (Incl. Diesel models with DEF tanks & Excl. 2022 1500 LTD and 22-24 models with super cruise system)

⑬	2		⑭	2	
		Bolt Plates M12x35			Double Bolt Plates M12x30
⑮	1		⑯	1	
		Adhesive Tape (L)			Adhesive Tape (R)
Hardware List:					
⑫	4		⑬	12	
		Hex Bolt (Full Thread) M8_25			Lock Washer D8
⑭	2		⑮	8	
		Flat Washer D8_28_3			Hex Bolt (Full Thread) M8_30
⑯	8		⑰	4	
		Button Head Bolt M8_30			Flat Washer D8_16_1.6
⑱	22		⑲	8	
		Flat Washer D8_24_2			Nylon Lock Nut M8
⑳	6		㉑	2	
		Hex Bolt(Full Thread) M10_30			Hex Bolt(Full Thread) M10_45
㉒	8		㉓	8	
		Hex Nut M10			Lock Washer D10
㉔	16		㉕	6	
		Flat Washer D10_27_3			Flat Washer D12_24_2.5
㉖	6		㉗	6	
		Hex Nut M12			Lock Washer D12
㉘	1				
		Allen Wrench S=5			

Installation Steps

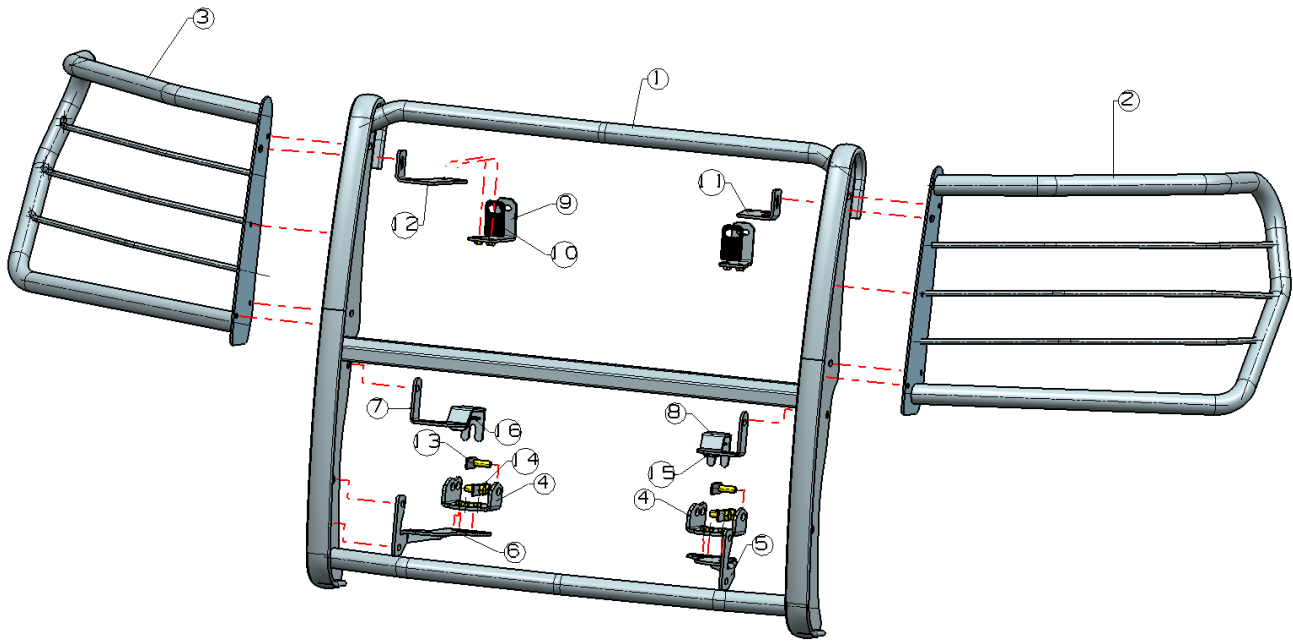

STEP1: Attach Mounting Bracket to Middle Guard, left/right sides installation way are same.

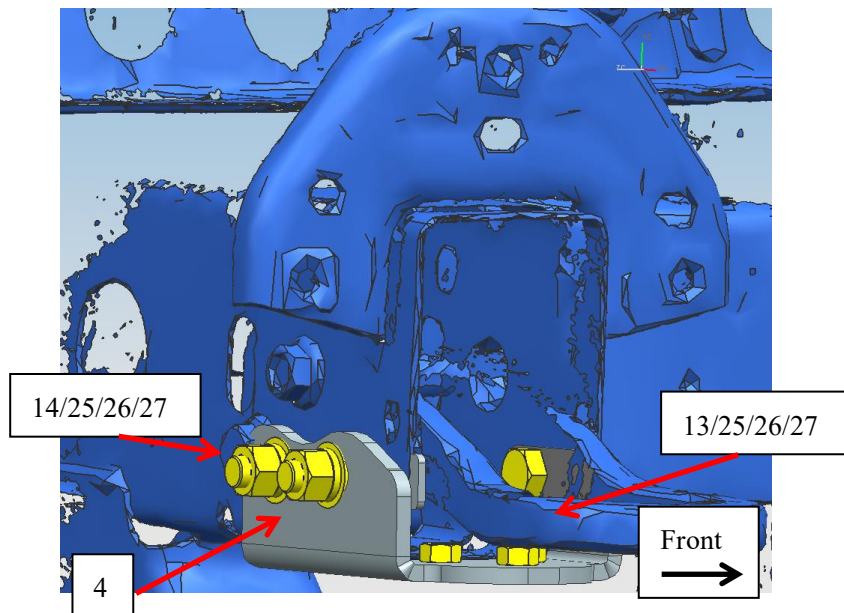

STEP2: Attach Lower Mounting Bracket with Mounting Bracket, left/right sides are install symmetrically.

- On vehicles equipped with the diesel engine or 4 cylinder turbo gasoline engine, removal of the front bumper is necessary to access the frame mounts to remove the factory tow hooks (if equipped) and to install the grille guard mount brackets. It may also be necessary to temporarily remove the intercooler shutter assembly if more space is needed. The factory bumper needs to be reinstalled before the new support bracket can be installed.

BLACK MODULAR GRILLE GUARD FOR 22-26 CHEVY SILVERADO 1500 (Incl. Diesel models with DEF tanks & Excl. 2022 1500 LTD and 22-24 models with super cruise system)

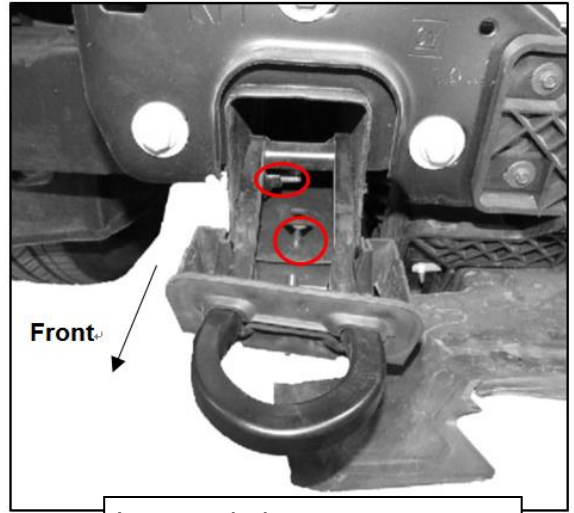
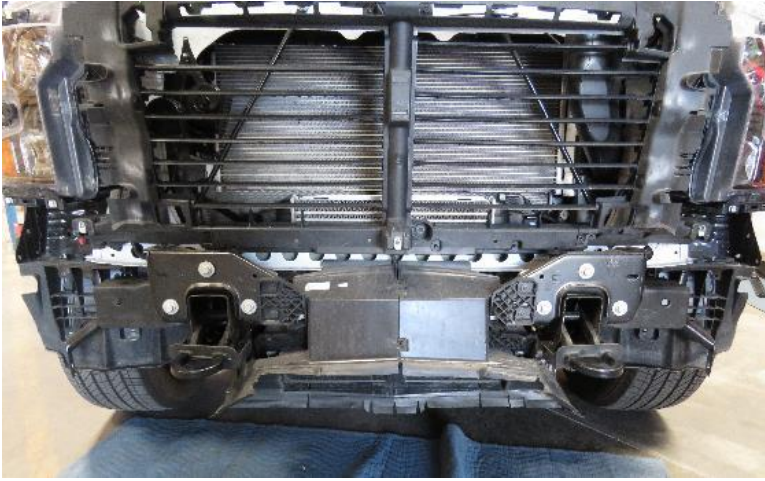

Loosen bolts to remove tow hooks

- Extra trimming of the tow hook cutouts is needed to allow the mount brackets to fit through.



- Install the brackets with provided hardware as below.

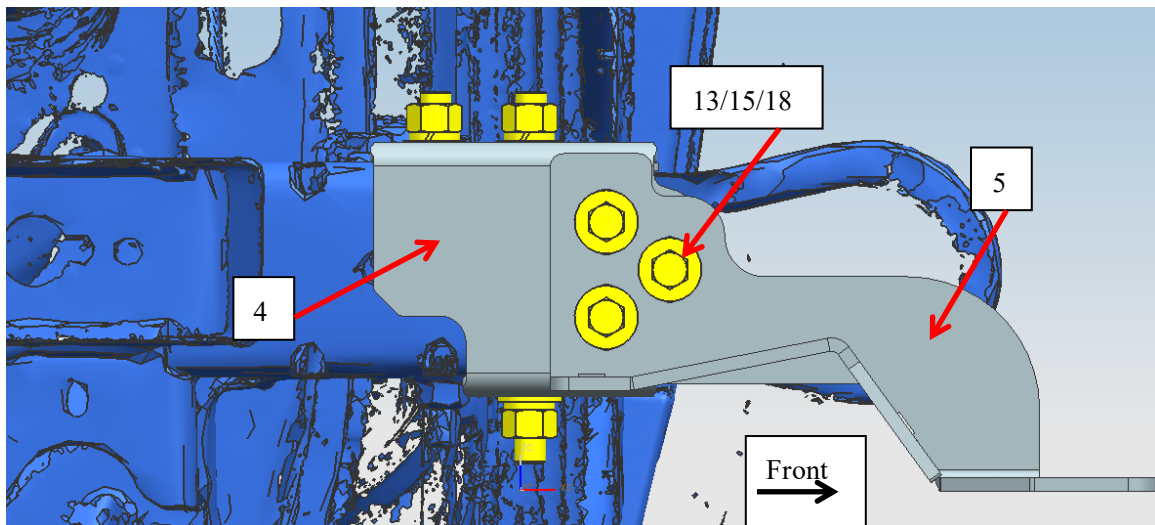

BLACK MODULAR GRILLE GUARD FOR 22-26 CHEVY SILVERADO 1500 (Incl. Diesel models with DEF tanks & Excl. 2022 1500 LTD and 22-24 models with super cruise system)

STEP3: Attach Support Bracket to Middle Guard, left/right sides are installed symmetrically.

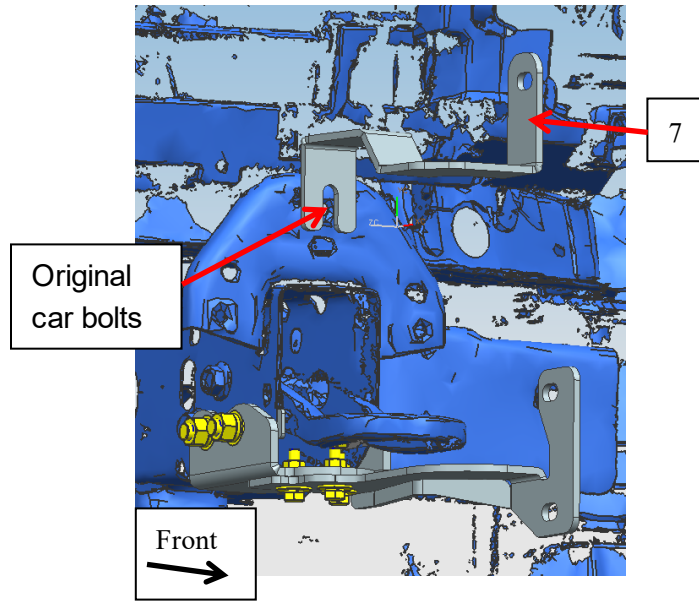

STEP4: Attach Top Support Bracket to the Car, left/right sides installation way are same.



(4-1) Remove plastic cover from top of grille



(4-2) Remove screws attaching grille and carefully pull grille straight out to remove grille

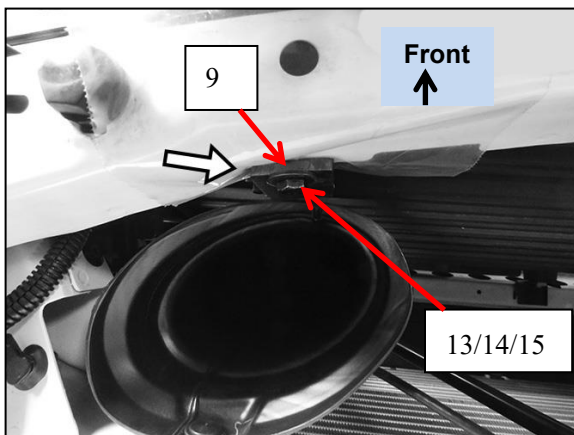

(4-3) Attach driver/left Inner Top Bracket to back of core support

STEP5: Remove top shutter blade, and then attach Upper Support Bracket to Top Support Bracket, left/right sides are installed symmetrically.

- In order to install the 2nd pair of support bracket, the top shutter blades on the PS and DS of the shutter must be removed so the bracket does not interfere with it opening and closing. This will not affect the operation of the shutters.

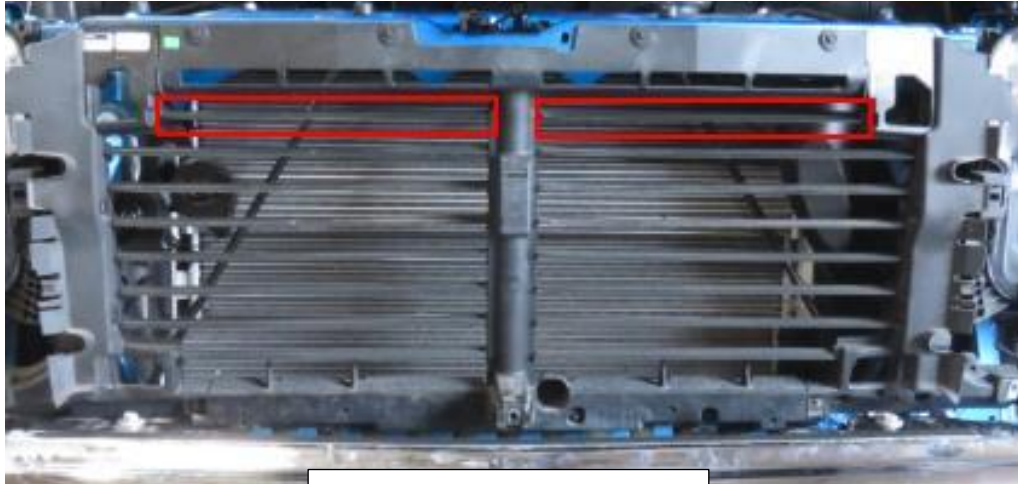

Shutter blades to remove

- If customers are not concerned with permanently altering the blades, they may bend them until the blades pop out of the housing or they could cut the tabs holding the blade in the housing. If the customer does not want to permanently alter the shutter blades, they must follow the steps below.

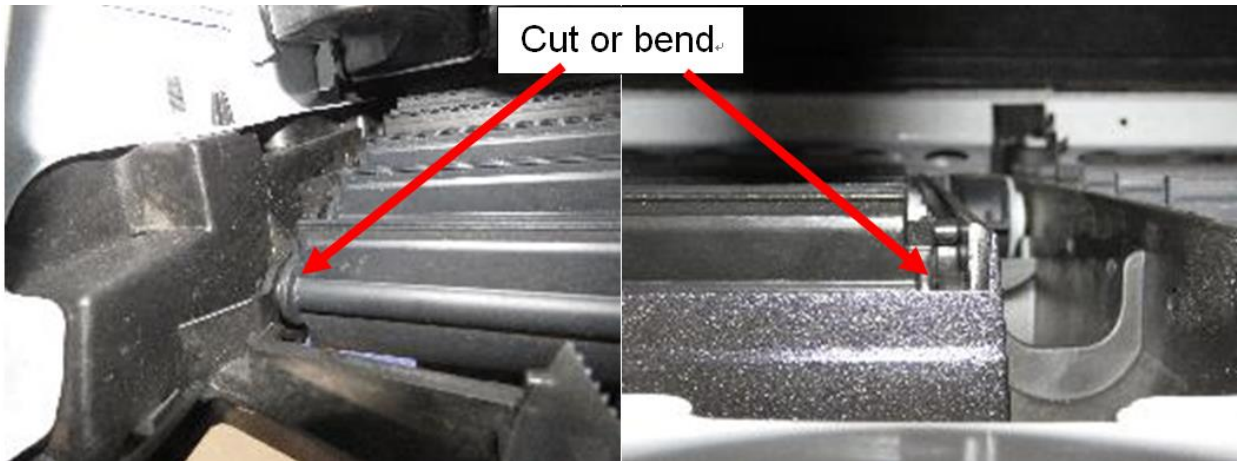

- The shutter must be loosened by removing the bolts depicted below to expose a clip that maintains the tension between the shutter blades and the plastic.

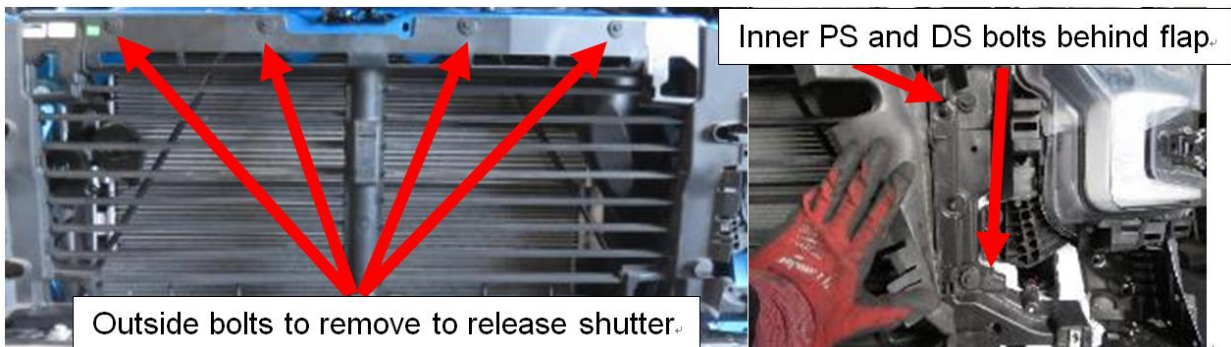

BLACK MODULAR GRILLE GUARD FOR 22-26 CHEVY SILVERADO 1500 (Incl. Diesel models with DEF tanks & Excl. 2022 1500 LTD and 22-24 models with super cruise system)

- Once the clip is undone then you can slightly pull the side sections from the center section of the shutter. BE CAREFUL not to fully remove the side section because unclipping the side loosens all shutter blades and fully removing the side will cause them all to fall.
- Remove top shutter blades, and retighten bolts.

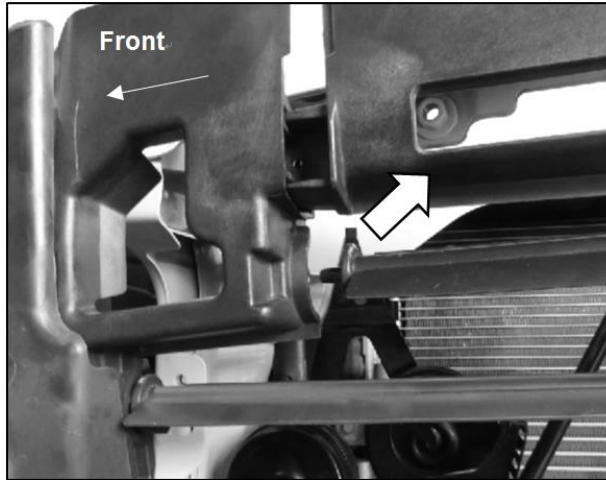

- Then attach the Upper Support Bracket to Top Support Bracket, left/right sides are installed symmetrically.

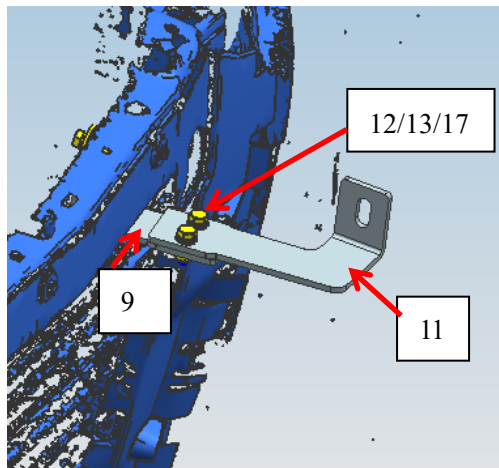

STEP6: Attach Middle Guard with Brush Guard, left/right side installation way are same.

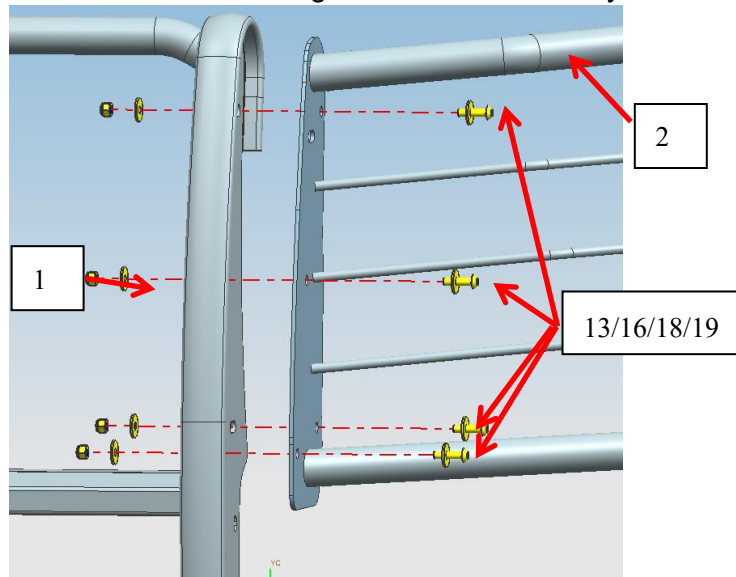

STEP 7: Attach Middle Guard to Lower Mounting Bracket and Support Bracket and Upper Support Bracket, left/right sides are installed symmetrically.

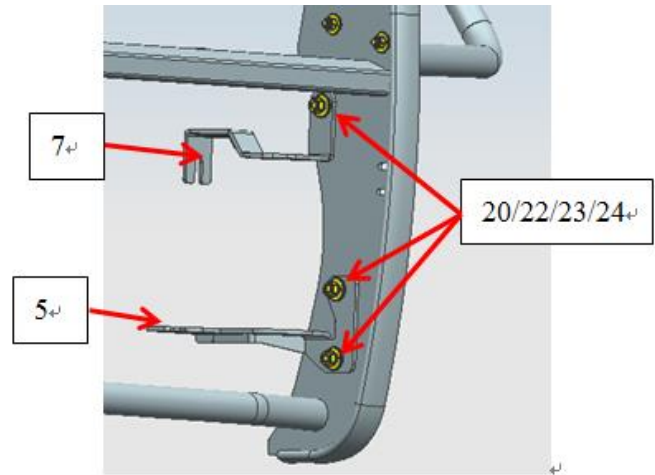
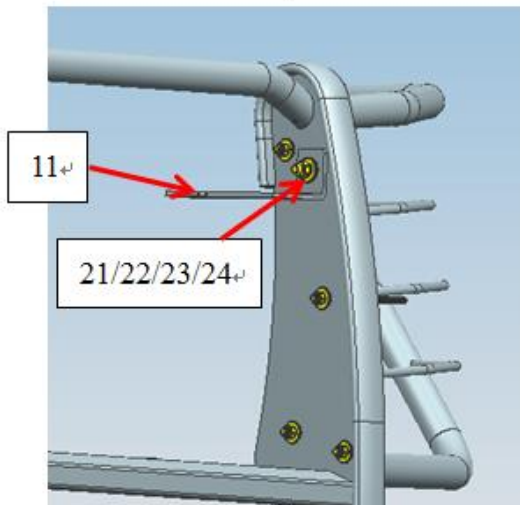

STEP 8: Adjust the gap between Middle Guard and Car body, tighten all hardware.

STEP 9: Complete installation, pick up all tools.

NOTE

Any damages and losses caused by improper installation and application, goes beyond our quality warranty.